



Compact range
22mm



8

22mm Compact range

The compact range is a new competitive choice for customers with high requirements of cost efficient, easy to use and reliable products.

General construction

- "All-in-one function"
- One Ref. code = one complete function
- Easy mounting
- Less inventory
- Broad range of accessories
- Same front design as for the modular range.
- Durable actuators in clear colors with large text and push area
- Marked push areas available
- UL File# E57057
- CSA File# LR19700

Technical advantages

- High degree of protection:
UL Type 1, 3R, 4, 4X, 12 & 13
- One or two built-in electrically separated contacts (1NO, 1NC, 2NO, 2NC or 1NC & 1NO)
- Contacts with wiping action
- Low built-in depth

Operators

- Pushbuttons, non-illuminated
- Emergency stop pushbuttons, non-illuminated, twist, pull or key release
- Selector switches, non-illuminated, 2 or 3 position

Pilot lights

- Ba 9s base for bulbs (6-130 V) or LED (12-130 V DC, 24-230 V AC)
- Pilot light with integrated LED (12-220 V DC, 24-230 V AC)



Flush and extended pushbuttons Non-illuminated

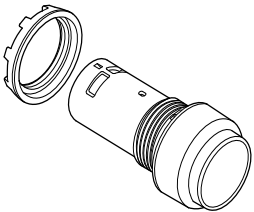
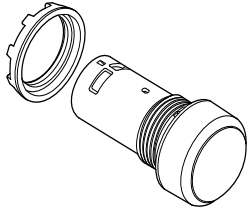

Bezel in black plastic as standard
Bezel in metal:

Replace '1' in the:
Catalog No. CP#10Δ-...
Ref. Code 1SFA619XXX R 1XXX
3 for metal bezel

Codes for button colors

	Catalog No.	Ref. Code
		‡
Red	R	1
Green	G	2
Yellow	Y	3
Blue	L	4
White	W	5
Black	B	6
Grey	U	7

Pushbutton with ...

Description	Catalog No.	Ref. Code	List Price
Flush button			
Momentary			
<u>Contacts included:</u>			
1 NO	CP110 -10	1SFA 619 100 R101‡	\$ 15.20
2 NO	CP110 -20	1SFA 619 100 R102‡	19.90
1 NC	CP110 -01	1SFA 619 100 R104‡	15.20
2 NC	CP110 -02	1SFA 619 100 R105‡	19.90
1 NO +1 NC	CP110 -11	1SFA 619 100 R107‡	19.90
Maintained			
<u>Contacts included:</u>			
1 NO	CP210 -10	1SFA 619 101 R101‡	19.90
2 NO	CP210 -20	1SFA 619 101 R102‡	22.50
1 NC	CP210 -01	1SFA 619 101 R104‡	19.90
2 NC	CP210 -02	1SFA 619 101 R105‡	22.50
1 NO +1 NC	CP210 -11	1SFA 619 101 R107‡	22.50
Extended button			
Momentary			
<u>Contacts included:</u>			
1 NO	CP310 -10	1SFA 619 102 R101‡	15.20
2 NO	CP310 -20	1SFA 619 102 R102‡	19.90
1 NC	CP310 -01	1SFA 619 102 R104‡	15.20
2 NC	CP310 -02	1SFA 619 102 R105‡	19.90
1 NO +1 NC	CP310 -11	1SFA 619 102 R107‡	19.90
Maintained			
<u>Contacts included:</u>			
1 NO	CP410 -10	1SFA 619 103 R101‡	19.90
2 NO	CP410 -20	1SFA 619 103 R102‡	22.50
1 NC	CP410 -01	1SFA 619 103 R104‡	19.90
2 NC	CP410 -02	1SFA 619 103 R105‡	22.50
1 NO +1 NC	CP410 -11	1SFA 619 103 R107‡	22.50

Marked pushbuttons

Marked on push area, non-illuminated
Momentary

Pilot Devices
Compact range
22mm

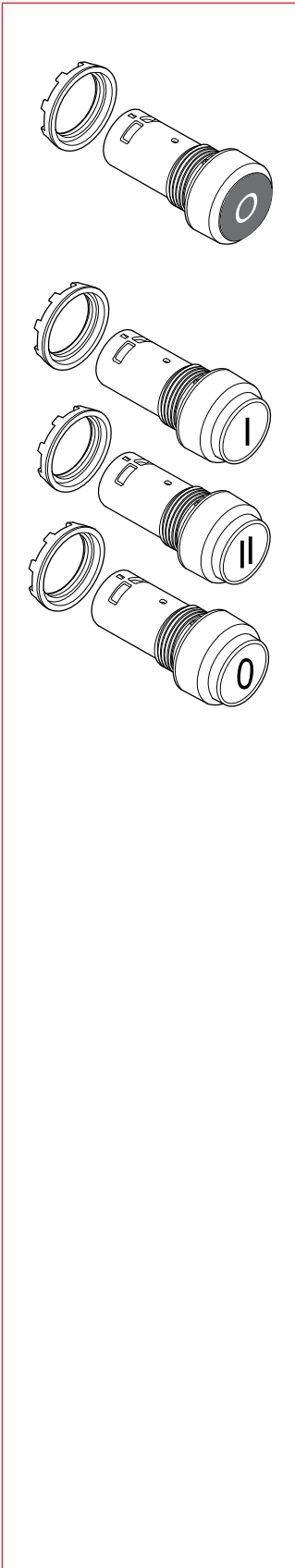

Legend	Button description ①	Contacts	Catalog Number	Reference. Code	List Price
	white, flush	1NO	CP1110W-10	1SFA619110R1015	\$ 16.70
	white, flush	1NO	CP1210W-10	1SFA619120R1015	16.70
	red, flush	1NC	CP1310R-01	1SFA619130R1041	16.70
	black, extended	1NC	CP3310B-01	1SFA619132R1046	16.70
	green, flush	1NO + 1NC	CP9-1007	1SFA619199R1007	21.00
	green, flush	2NO	CP9-1008	1SFA619199R1008	21.00
	grey, flush	1NO + 1NC	CP9-1025	1SFA619199R1025	21.00
	red, flush	1NO + 1NC	CP9-1009	1SFA619199R1009	21.00
	red, flush	2NO	CP9-1010	1SFA619199R1010	21.00
	red, extended	1NO + 1NC	CP9-1018	1SFA619199R1018	21.00
	green, flush	1NO + 1NC	CP9-1033	1SFA619199R1033	21.00
	red, flush	1NO + 1NC	CP9-1034	1SFA619199R1034	21.00
	blue, flush	1NO + 1NC	CP9-1021	1SFA619199R1021	21.00
	black, flush	1NO + 1NC	CP9-1015	1SFA619199R1015	21.00

① Black bezel available only.

Marked pushbuttons

Marked on push area, non-illuminated
Momentary

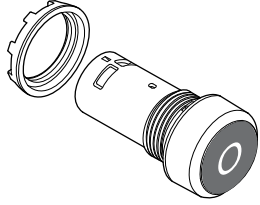

Legend	Button description ①	Contacts	Catalog Number	Reference. Code	List Price
	black, extended	1NO + 1NC	CP9-1017	1SFA619199R1017	\$ 21.00
	black, flush	1NO + 1NC	CP9-1016	1SFA619199R1016	21.00
	black, flush	2NO	CP9-1032	1SFA619199R1032	21.00
	white, flush	1NO	CP9-1022	1SFA619199R1022	16.70
	white, flush	1NO + 1NC	CP9-1005	1SFA619199R1005	21.00
	white, flush	2NO	CP9-1006	1SFA619199R1006	21.00
	green, flush	1NO + 1NC	CP9-1019	1SFA619199R1019	21.00
	black, flush	1NO + 1NC	CP9-1020	1SFA619199R1020	21.00
	white, flush	1NO	CP9-1024	1SFA619199R1024	16.70
	black, flush	2NO	CP9-1023	1SFA619199R1023	21.00
	black, flush	1NO + 1NC	CP9-1045	1SFA619199R1045	21.00
	black, flush	1NO + 1NC	CP9-1046	1SFA619199R1046	21.00
	black, flush	1NO + 1NC	CP9-1047	1SFA619199R1047	21.00
	black, flush	1NO + 1NC	CP9-1048	1SFA619199R1048	21.00

① Black bezel available only.

Emergency stop pushbuttons

Non-illuminated

Pilot Devices
Compact range
22mm

Fulfills IEC 60947-5-5

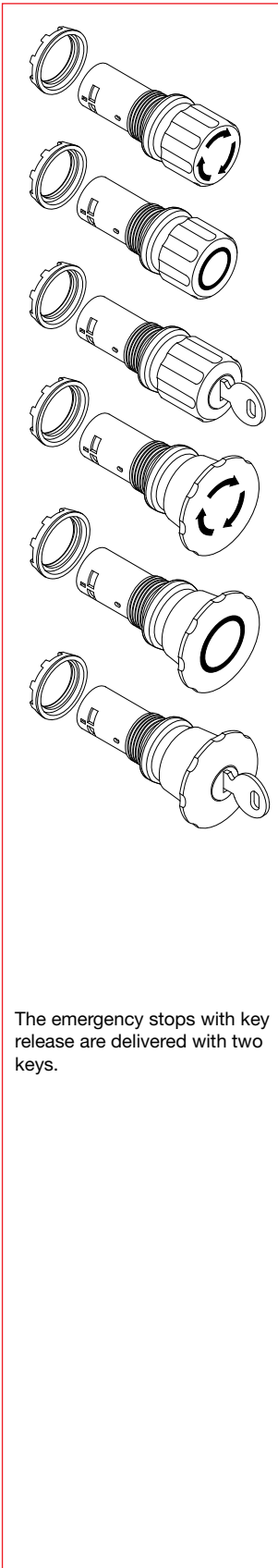

The emergency stops with key release are delivered with two keys.

Plastic operator

Description	Color	Catalog No.	Ref. Code	List Price
Ø 30 mm				
Twist release				
<u>Contacts included:</u>				
1 NC	Red	CE3T-10R-01	1SFA 619 500 R1041	\$ 28.00
2 NO	Red	CE3T-10R-20	1SFA 619 500 R1021	33.60
2 NC	Red	CE3T-10R-02	1SFA 619 500 R1051	33.60
1 NO +1 NC	Red	CE3T-10R-11	1SFA 619 500 R1071	33.60
1 NO +1 NC	Black	CE3T-10B-11	1SFA 619 500 R1076	33.60
Pull release				
<u>Contacts included:</u>				
2 NC	Red	CE3P-10R-02	1SFA 619 501 R1051	33.60
1 NO +1 NC	Red	CE3P-10R-11	1SFA 619 501 R1071	33.60
1 NO +1 NC	Black	CE3P-10B-11	1SFA 619 501 R1076	33.60
Key release (Key code 71, Ronis 455)				
<u>Contacts included:</u>				
2 NC	Red	CE3K1-10R-02	1SFA 619 502 R1051	53.40
1 NO +1 NC	Red	CE3K1-10R-11	1SFA 619 502 R1071	53.40
1 NO +1 NC	Black	CE3K1-10B-11	1SFA 619 502 R1076	53.40
Ø 40 mm				
Twist release				
<u>Contacts included:</u>				
1 NC	Red	CE4T-10R-01	1SFA 619 550 R1041	30.80
2 NO	Red	CE4T-10R-20	1SFA 619 550 R1021	36.40
2 NC	Red	CE4T-10R-02	1SFA 619 550 R1051	36.40
1 NO +1 NC	Red	CE4T-10R-11	1SFA 619 550 R1071	36.40
1 NO & 1 NC	Black	CE4T-10B-11	1SFA 619 550 R1076	36.40
Pull release				
<u>Contacts included:</u>				
2 NC	Red	CE4P-10R-02	1SFA 619 551 R1051	36.40
1 NO +1 NC	Red	CE4P-10R-11	1SFA 619 551 R1071	36.40
1 NO +1 NC	Black	CE4P-10B-11	1SFA 619 551 R1076	36.40
Key release (Key code 71, Ronis 455)				
<u>Contacts included:</u>				
2 NC	Red	CE4K1-10R-02	1SFA 619 552 R1051	57.50
1 NO +1 NC	Red	CE4K1-10R-11	1SFA 619 552 R1071	57.50
1 NO +1 NC	Black	CE4K1-10B-11	1SFA 619 552 R1076	57.50
"EMO" Marking				
Twist release				
<u>Contacts included:</u>				
2 NC	Red	CE9-1003	1SFA 619 599 R1003	36.40
Pull release				
<u>Contacts included:</u>				
2 NC	Red	CE9-1004	1SFA 619 599 R1004	36.40

2 and 3 position selector switches Non-illuminated

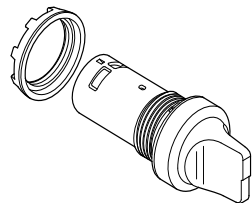

Contacts actuated

Two position selector switch

Contacts included,

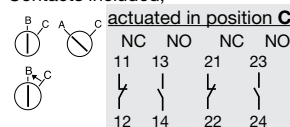

1NO	-	1	-	-
2NO	-	1	-	1
1NC	1	-	-	-
2NC	1	-	1	-
1NO + 1NC	-	1	1	-

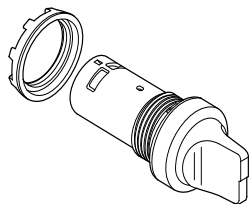

Bezel in black plastic as standard

Bezel in metal:

Replace '1' in the:

Catalog No. C#SS#10Δ-...

Ref. Code 1SFA619XXX R 1XXX

3 for metal bezel

Contacts actuated

Three position selector switch

Contacts included,

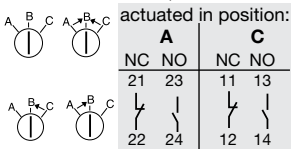

2NO	-	1	-	1
2NC	1	-	1	-
1NO + 1NC	1	-	-	1

Codes for handle colors

	Catalog No.	Ref. Code
		‡
Red	R	1
Black	B	6
Grey	U	7

Selector switch with ...

Description	Catalog No.	Ref. Code	List Price
-------------	-------------	-----------	------------

Short handle. Two positions

Maintained

Contacts included:

1 NO	 C2SS110 -10	1SFA 619 200 R101‡	\$ 22.70
2 NO	C2SS110 -20	1SFA 619 200 R102‡	27.20
1 NC	C2SS110 -01	1SFA 619 200 R104‡	22.70
2 NC	C2SS110 -02	1SFA 619 200 R105‡	27.20
1 NO + 1 NC	C2SS110 -11	1SFA 619 200 R107‡	27.20

Maintained

Contacts included:

1 NO	 C2SS210 -10	1SFA 619 201 R101‡	22.70
2 NO	C2SS210 -20	1SFA 619 201 R102‡	27.20
1 NC	C2SS210 -01	1SFA 619 201 R104‡	22.70
2 NC	C2SS210 -02	1SFA 619 201 R105‡	27.20
1 NO + 1 NC	C2SS210 -11	1SFA 619 201 R107‡	27.20

Momentary

Contacts included:

1 NO	 C2SS310 -10	1SFA 619 202 R101‡	22.70
2 NO	C2SS310 -20	1SFA 619 202 R102‡	27.20
1 NC	C2SS310 -01	1SFA 619 202 R104‡	22.70
2 NC	C2SS310 -02	1SFA 619 202 R105‡	27.20
1 NO + 1 NC	C2SS310 -11	1SFA 619 202 R107‡	27.20

Short handle. Three positions

Maintained

Contacts included:

2 NO	 C3SS110 -20	1SFA 619 210 R102‡	27.20
2 NC	C3SS110 -02	1SFA 619 210 R105‡	
1 NO + 1 NC	C3SS110 -11	1SFA 619 210 R107‡	

Momentary

Contacts included:

2 NO	 C3SS210 -20	1SFA 619 211 R102‡	27.20
2 NC	C3SS210 -02	1SFA 619 211 R105‡	
1 NO + 1 NC	C3SS210 -11	1SFA 619 211 R107‡	

Momentary

Contacts included:

2 NO	 C3SS310 -20	1SFA 619 212 R102‡	27.20
2 NC	C3SS310 -02	1SFA 619 212 R105‡	
1 NO + 1 NC	C3SS310 -11	1SFA 619 212 R107‡	

Momentary

Contacts included:

2 NO	 C3SS710 -20	1SFA 619 216 R102‡	27.20
2 NC	C3SS710 -02	1SFA 619 216 R105‡	
1 NO + 1 NC	C3SS710 -11	1SFA 619 216 R107‡	

Ordering example – Compact selector switch

Requested: A red compact selector switch with three positions, Momentary, spring return from A to B and maintained position in C. With 2 NC contacts.

Ref.: 10 pieces of C3SS7-10R-02

Minimum Ref. quantity: 10 pieces
Packing: 10 pieces/plastic bag, 10 bags/box

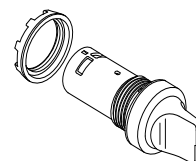

Pilot lights

Pilot Devices
Compact range
22mm

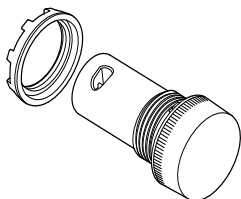

Pilot light Ba 9s base, bulb not included

Description	Catalog No.	Ref. Code	List Price
Color:			
Red	CL-100R	1SFA 619 402 R1001	\$ 14.00
Green	CL-100G	1SFA 619 402 R1002	
Yellow	CL-100Y	1SFA 619 402 R1003	
Blue	CL-100L	1SFA 619 402 R1004	
White	CL-100W	1SFA 619 402 R1005	
Clear	CL-100C	1SFA 619 402 R1008	

Pilot light with integrated LED Service life >50 000 hours

Color	Rated current mA	Luminance mcd	Wave-length nm	Catalog No.	Ref. Code	List Price
Rated voltage 12 V, DC ①						
Red	30	60	625	CL-501R	1SFA 619 402 R5011	\$ 25.00
Green	15	126	520	CL-501G	1SFA 619 402 R5012	
Yellow	30	60	590	CL-501Y	1SFA 619 402 R5013	
Blue	30	22	470	CL-501L	1SFA 619 402 R5014	
White	30	88	②	CL-501W	1SFA 619 402 R5015	
Rated voltage 24 V, AC/DC						
Red	15	60	625	CL-502R	1SFA 619 402 R5021	25.00
Green	15	126	520	CL-502G	1SFA 619 402 R5022	
Yellow	15	60	590	CL-502Y	1SFA 619 402 R5023	
Blue	15	22	470	CL-502L	1SFA 619 402 R5024	
White	15	88	②	CL-502W	1SFA 619 402 R5025	
Rated voltage 48 V, AC/DC						
Red	15	60	625	CL-504R	1SFA 619 402 R5041	25.00
Green	15	126	520	CL-504G	1SFA 619 402 R5042	
Yellow	15	60	590	CL-504Y	1SFA 619 402 R5043	
Blue	15	22	470	CL-504L	1SFA 619 402 R5044	
White	15	88	②	CL-504W	1SFA 619 402 R5045	
Rated voltage 60 V, AC/DC						
Red	15	60	625	CL-505R	1SFA 619 402 R5051	25.00
Green	15	126	520	CL-505G	1SFA 619 402 R5052	
Yellow	15	60	590	CL-505Y	1SFA 619 402 R5053	
Blue	15	22	470	CL-505L	1SFA 619 402 R5054	
White	15	88	②	CL-505W	1SFA 619 402 R5055	
Rated voltage 110-130 V, AC						
Red	15	60	625	CL-513R	1SFA 619 402 R5131	25.00
Green	15	126	520	CL-513G	1SFA 619 402 R5132	
Yellow	15	60	590	CL-513Y	1SFA 619 402 R5133	
Blue	15	22	470	CL-513L	1SFA 619 402 R5134	
White	15	88	②	CL-513W	1SFA 619 402 R5135	
Rated voltage 110-130 V, DC ①						
Red	15	60	625	CL-515R	1SFA 619 402 R5151	25.00
Green	15	126	520	CL-515G	1SFA 619 402 R5152	
Yellow	15	60	590	CL-515Y	1SFA 619 402 R5153	
Blue	15	22	470	CL-515L	1SFA 619 402 R5154	
White	15	88	②	CL-515W	1SFA 619 402 R5155	
Rated voltage 220 V, DC ①						
Red	15	60	625	CL-520R	1SFA 619 402 R5201	25.00
Green	15	126	520	CL-520G	1SFA 619 402 R5202	
Yellow	15	60	590	CL-520Y	1SFA 619 402 R5203	
Blue	15	22	470	CL-520L	1SFA 619 402 R5204	
White	15	88	②	CL-520W	1SFA 619 402 R5205	
Rated voltage 230 V, AC						
Red	15	60	625	CL-523R	1SFA 619 402 R5231	25.00
Green	15	126	520	CL-523G	1SFA 619 402 R5232	
Yellow	15	60	590	CL-523Y	1SFA 619 402 R5233	
Blue	15	22	470	CL-523L	1SFA 619 402 R5234	
White	15	88	②	CL-523W	1SFA 619 402 R5235	
Rated voltage 380 V, AC						
Red	15	60	625	CL-530R	1SFA 619 402 R5301	25.00
Green	15	126	520	CL-530G	1SFA 619 402 R5302	
Yellow	15	60	590	CL-530Y	1SFA 619 402 R5303	
Blue	15	22	470	CL-530L	1SFA 619 402 R5304	
White	15	88	②	CL-530W	1SFA 619 402 R5305	
Rated voltage 415 V, AC						
Red	15	60	625	CL-541R	1SFA 619 402 R5411	25.00
Green	15	126	520	CL-541G	1SFA 619 402 R5412	
Yellow	15	60	590	CL-541Y	1SFA 619 402 R5413	
Blue	15	22	470	CL-541L	1SFA 619 402 R5414	
White	15	88	②	CL-541W	1SFA 619 402 R5415	

① Care should be taken for DC supply where + and - must be correctly connected. (this is marked on the product, X1 (+) and X2 (-)).

② X=0.31, Y=0.32

Minimum Ref. quantity: 10 pieces
Packing: 10 pieces/plastic bag, 10 bags/box

Accessories



Filament bulbs Ba 9s base Catalog No. of current: AC/DC. A lamp changing tool is required for changing bulb.

Description					Catalog No.	Ref. Code	List Price
Rated voltage V	Rated current mA	Rated output W	Service life h	Lumina-nance mcd			
6	200	1.2	10 000	350	5911 086-11	5911 086-11	\$ 6.00
12	100	1.2	10 000	230	5911 086-12	5911 086-12	
24	50	1.2	10 000	280	5911 086-13	5911 086-13	
30	40	1.2	10 000	250	5911 086-4	5911 086-4	
48	42	2	6 000	500	5911 086-5	5911 086-5	
60	20	1.2	5 000	190	5911 086-14	5911 086-14	
110	18	2	7 500	250	5911 086-7	5911 086-7	
130	15	2	7 500	120	5911 086-15	5911 086-15	

LEDs

With one diode chip mounted on a Ba 9s base. Choose the same color for the LED and the lamp cap or else use a clear lamp cap.

For white light use white LED with clear lamp cap. At DC the lamp base have to be connected to cathode (-) and the bottom contact to anode (+).



Color	Rated current mA	Wave-length nM	Lumi-nance mcd	Catalog No.	Ref. Code	List Price
Rated voltage 12 V, DC Service life >50 000 h						
Red	15	630	250	KA2-2011	1SFA 616 921 R2011	\$ 21.00
Green	15	525	1000	KA2-2012	1SFA 616 921 R2012	
Yellow	15	592	250	KA2-2013	1SFA 616 921 R2013	
Blue	15	470	450	KA2-2014	1SFA 616 921 R2014	
White	15	x=0.31 y=0.32	600	KA2-2015	1SFA 616 921 R2015	
Rated voltage 24 V, (AC)/DC Service life >50 000 h						
Red	15	630	250	KA2-2021	1SFA 616 921 R2021	15.00
Green	15	525	800	KA2-2022	1SFA 616 921 R2022	
Yellow	15	592	250	KA2-2023	1SFA 616 921 R2023	
Blue	15	470	400	KA2-2024	1SFA 616 921 R2024	
White	15	x=0.31 y=0.32	500	KA2-2025	1SFA 616 921 R2025	
Rated voltage 48 V, (AC)/DC Service life >50 000 h						
Red	12	630	200	KA2-2041	1SFA 616 921 R2041	15.00
Green	12	525	1700	KA2-2042	1SFA 616 921 R2042	
Yellow	12	592	240	KA2-2043	1SFA 616 921 R2043	
Blue	12	470	720	KA2-2044	1SFA 616 921 R2044	
White	12	x=0.31 y=0.32	1200	KA2-2045	1SFA 616 921 R2045	
Rated voltage 60 V, (AC)/DC Service life >50 000 h						
Red	10	630	160	KA2-2051	1SFA 616 921 R2051	21.00
Green	10	525	1400	KA2-2052	1SFA 616 921 R2052	
Yellow	10	592	200	KA2-2053	1SFA 616 921 R2053	
Blue	10	470	600	KA2-2054	1SFA 616 921 R2054	
White	10	x=0.31 y=0.32	1000	KA2-2055	1SFA 616 921 R2055	
Rated voltage 110-130 V, AC Service life 25 000 h						
Red	4-6	630	60-100	KA2-2131	1SFA 616 921 R2131	15.00
Green	4-6	525	500-850	KA2-2132	1SFA 616 921 R2132	
Yellow	4-6	592	70-120	KA2-2133	1SFA 616 921 R2133	
Blue	4-6	470	220-350	KA2-2134	1SFA 616 921 R2134	
White	4-6	x=0.31 y=0.32	350-600	KA2-2135	1SFA 616 921 R2135	
Rated voltage 110-130 V, AC/DC Service life 25 000 h						
Red	4-6	630	60-100	KA2-2141	1SFA 616 921 R2141	21.00
Green	4-6	525	500-850	KA2-2142	1SFA 616 921 R2142	
Yellow	4-6	592	70-120	KA2-2143	1SFA 616 921 R2143	
Blue	4-6	470	220-350	KA2-2144	1SFA 616 921 R2144	
White	4-6	x=0.31 y=0.32	350-600	KA2-2145	1SFA 616 921 R2145	
Rated voltage 230 V, AC Service life 25 000 h						
Red	4	630	60	KA2-2221	1SFA 616 921 R2221	21.00
Green	4	525	500	KA2-2222	1SFA 616 921 R2222	
Yellow	4	592	70	KA2-2223	1SFA 616 921 R2223	
Blue	4	470	220	KA2-2224	1SFA 616 921 R2224	
White	4	x=0.31 y=0.32	350	KA2-2225	1SFA 616 921 R2225	

Ⓢ At AC the luminance is decreased with 30 % and there is also a slight flickering.

Accessories

Pilot Devices
Compact range
22mm

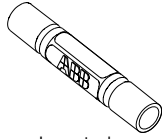

Lamp tool



Mounting tool



Silicone boot



Protective ring

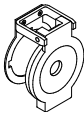

Protective cover



Pushbutton lens



Bezel

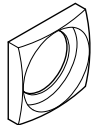

Square bezel

Lamp changing tool

Description	Catalog No.	Ref. Code	List Price
For LEDs and for bulbs	KA1-8072	1SFA 616 920 R8072	\$ 10.00

Mounting tool

Description	Catalog No.	Ref. Code	List Price
Used for tightening the locking nut	KA1-8015	1SFA 611 920 R8015	\$ 10.00

Silicone boot

Of transparent, heat and cold resistant silicon rubber. Does not harden at low temperature. Gives IP 67 degree of protection. When membrane is used, remove the gasket.

For operator with	Catalog No.	Ref. Code	List Price
Flush button	KA1-8052	1SFA 616 920 R8052	\$ 8.00
Extended button	KA1-8002	1SFA 616 920 R8002	8.00

Protective ring

Description	Catalog No.	Ref. Code	List Price
For flush and extended pushbutton To prevent inadvertant operation. Not together with legend plate holder.	SK615512-1	SK 615 512-1	\$ 4.00

Protective cover

Description	Catalog No.	Ref. Code	List Price
For flush button. To prevent inadvertant operation. Not together with legend plate holder.	KA1-8010	1SFA 616 920 R8010	\$ 15.00

Button ①

Description	Catalog No.	Ref. Code	List Price
Grey, flush (Packing unit 10 pieces)	KA1-8087	1SFA 616 920 R8087	\$ 1.50
Grey, extended (Packing unit 10 pieces)	KA1-8097	1SFA 616 920 R8097	1.50

Bezel

Description	Catalog No.	Ref. Code	List Price
For pushbutton			
Grey (Packing unit 10 pieces)	KA1-8079	1SFA 616 920 R8079	\$ 1.00
Black (Packing unit 10 pieces)	KA1-8022	1SFA 616 920 R8022	1.00
Metal (Packing unit 10 pieces)	KA1-8021	1SFA 616 920 R8021	2.50
For selector switch			
Grey (Packing unit 10 pieces)	KA1-8077	1SFA 619 920 R8076	1.00
Black (Packing unit 10 pieces)	KA1-8080	1SFA 619 920 R8077	1.00
Metal (Packing unit 10 pieces)	KA1-8024	1SFA 619 920 R8078	2.50

Square bezel

Black, plastic (Packing unit 10 pieces)	SK 616 016-2	SK 616 016-2	2.00
Grey, plastic (Packing unit 10 pieces)	KA1-8124	1SFA 611 920 R8124	2.00

Blanking plug (22mm)

Description	Catalog No.	Ref. Code	List Price
Grey plastic	MA1-8129	1SFA 611 920 R8129	\$ 5.80
Black plastic	MA1-8130	1SFA 611 920 R8130	5.80

Blanking plug (30mm)

Description	Catalog No.	Ref. Code	List Price
Black plastic	MA1-8133	1SFA 611 920 R8133	\$ 7.30

① For other colors, see Accessories in the Modular Section.

Accessories



30 mm adaptors

For use when fitting the 22 mm pilot devices in 30 mm mounting holes. (1.5 – 4 mm panels)

Description	Catalog No.	Ref. Code	List Price
For use with pushbuttons, selector switches, emergency stop push-button and pilot lights Black plastic.	KA1-8029	1SFA 616 920 R8029	\$ 8.00
	KA1-8030	1SFA 616 920 R8030	10.00



Adaptors

For flush mounted pushbutton	KA1-8073	1SFA 616 920 R8073	15.00
For flush mounted selector switches	CA1-8075	1SFA 619 920 R8075	



Extra key (packing unit, 2 pcs)

Description	Catalog No.	Ref. Code	List Price
Ronis 455 (key code 71)	SK 616 021-71	SK 616 021-71	\$ 10.00



Padlock attachment for 30mm mushroom head (twist release only)

Prevents unauthorized use of equipment. Provides space for up to 4 padlocks with the button in the depressed position. Holes fit standard 1/4" padlock.

Description	Catalog No.	List Price
Padlock attachment	SK 615 502-D	\$ 20.00



Approvals

The pushbuttons, selector switches and pilot lights are approved by:
- National approval agencies: UL and China Compulsory Product Certification

For detail information please contact ABB

Standards

IEC 60947-1	Low-voltage switchgear and controlgear - Part 1: General rules
IEC 60947-5-1	Low-voltage switchgear and controlgear - Part 5-1: Control circuit devices and switching elements - Electromechanical control circuit devices
IEC 60947-5-5	Low-voltage switchgear and controlgear - Part 5-5: Control circuit devices and switching elements - Electrical emergency stop device with mechanical latching function
IEC 60073	Basic and safety principles for man-machine interface, marking and identification - Coding principles for indicators and actuators
IEC 60529	Degrees of protection provided by enclosures (IP Code)
EN 60947-1	Low-voltage switchgear and controlgear - Part 1: General rules
EN 60947-5-1	Low-voltage switchgear and controlgear - Part 5-1: Control circuit devices and switching elements - Electromechanical control circuit devices
EN 60947-5-5	Low-voltage switchgear and controlgear - Part 5-5: Control circuit devices and switching elements - Electrical emergency stop device with mechanical latching function
EN 60073	Basic and safety principles for man-machine interface, marking and identification - Coding principles for indication devices and actuators
EN 60529	Degrees of protection provided by enclosures (IP Code)
EN 50013	Low-voltage switchgear and controlgear for industrial use - Terminal marking and distinctive number for particular control switches
UL 508	Industrial Control Equipment
CSA C22.2 No 14	Industrial Control Equipment

Degrees of protection

Pilot device	IP	UL/CSA
Compact pushbutton, CP1, CP2, CP3, CP4	IP66, 67, 69K	Type 1, 3R, 4, 4X, 12, 13
Compact selector switch, C2SS, C3SS		
Compact pilot light, CL		
Compact emergency stop pushbutton, CE3T, CE3P, CE4T, CE4P, CE3K1, CE4K1		
Enclosures CEP	IP66, 67, 69K	Type 1, 3R, 4, 4X, 12, 13
Terminals	IP20	

Temperature

Ambient temperature during operation	-25 to +70 °C
Exception: All pilot devices with 2 W continuously lit filament bulb	-25 to +40 °C
Storage temperature	-30 to +85 °C

Tightening torque

Locking nut, M22	Min. 2 Nm Max. 2.3 Nm
------------------	--------------------------

Contacts

Self-cleaning contacts of silver-coated brass

Ratings as per UL, CSA, NEMA	AC C300	DC R300
Rated insulation voltage	250 V	250 V
Rated thermal current	2.5 A	1 A
Rated operational current		
at 120 V	1.5 A	
125 V		0.22 A
240 V	0.75 A	
250 V		0.11 A
Ratings as per IEC 60947-5-1		
Rated insulation voltage, U_i	300 V	
Rated thermal current, I_{th}	5 A	
Rated operational current, I_o , utilisation category AC-15		
at 120 V	1.5 A	
240 V	1 A	
Rated operational current, I_o , utilisation category DC-13,		
at 24 V	0.3 A	
125 V	0.2 A	
Short circuit protection		
Max. fuse at 1 kA	16 A ordinary 10 A delayed	
Tightening torque		
compact pushbutton & selector switch	0.8 Nm (M3)	
compact pilot light	0.9 Nm (M3.5)	
compact emergency stop pushbutton	0.8 Nm (M3)	
Terminals		
Plus-minus Pozidriv No. 2		
Compact pushbutton		
Compact selector switch		
Compact emergency stop		
Connectable area	min. 1 x 0.5 mm ² /1 x AWG22 max. 2 x 1.5 mm ² /2 x AWG14	
Compact pilot light		
Connectable area	min. 1 x 0.5 mm ² /1 x AWG20 max. 2 x 2.5 mm ² /2 x AWG14	

Material – UV protection according to UL 746 (C)

No ozone depleting substances in the products.

All front parts are made of polycarbonate

Material	Characteristics
PC Polycarbonate	High impact strength, good outdoor resistance. Can withstand light acid solutions, aliphatic hydrocarbons, paraffin, alcohols, animal and vegetable greases.
PA Polyamide	Can withstand high temperatures, aliphatic, aromatic and chlorinated hydrocarbons, esters, ketone-aldehydes, alcohols and basic solutions.
PBT	Can withstand temperature, aliphatic and aromatic hydrocarbons, acids, basic solutions, alcohols, grease and oils
Zinc	Good corrosion resistance in inland-, sea and industrial atmosphere.
Light-alloy	Good corrosion resistance in inland-, sea and industrial atmosphere.
Rubber	Chloroprene, Nitrile