



Technical catalogue

# Modular DIN rail components

## Installation contactors

Power and productivity  
for a better world™



Phone: 800.894.0412 - Fax: 888.723.4773 - Web: [www.clrwtr.com](http://www.clrwtr.com) - Email: [info@clrwtr.com](mailto:info@clrwtr.com)

# Installation Contactors



<b>Overview</b> .....	2
<b>ESB Installation Contactors</b>	
20 A / AC-1/AC-7a <b>ESB 20</b> .....	4
24 A / AC-1/AC-7a <b>ESB 24</b> .....	5
40 A / AC-1/AC-7a <b>ESB 40</b> .....	6
63 A / AC-1/AC-7a <b>ESB 63</b> .....	7
<b>Main Technical Data</b> .....	8
<b>Lighting application</b> .....	13
<b>EN Installation Contactors - Manually/Automatic operated</b>	
20 A / AC-1/AC-7a <b>EN 20</b> .....	14
24 A / AC-1/AC-7a <b>EN 24</b> .....	15
40 A / AC-1/AC-7a <b>EN 40</b> .....	16
<b>Main Technical Data</b> .....	17
<b>ESB/EN Installation Contactors</b>	
<b>Main Accessories</b> .....	19

# Modular DIN rail components

## Installation Contactors ESB and EN

All over the world, commercial and industrial buildings such as hospitals, hotels, shopping and sport centers, domestic and residential installation are equipped with ABB low voltage products and systems.

From switchboard to light switch, ABB covers the complete range of equipment required for controlling and protecting electrical installations.



## Typical segments

1-2 Residential installations | 3 Hotels

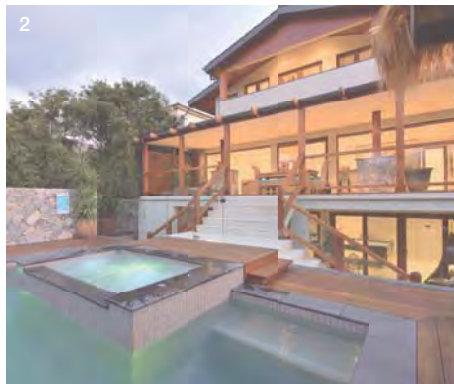

For controlling and remote switching, ABB offers a complete range of installation contactors that are mainly used in the following applications:

- Lighting
- Heating
- Ventilation
- Pumps and motors.

ESB and EN installation contactors are designed to match the Modular DIN rail components for common use in dedicated panels.

The ESB range includes 4 ratings from 20A to 63A with 2 to 4-pole version.

The EN range includes 3 ratings from 20A to 40A.

Many contacts variations are available for managing all application. Products comply with standards IEC60947-4-1 and IEC61095.

**Construction:**

The ESB/EN20 operates with an AC solenoid system.

Types ESB/EN 24, 40 and 63 are fitted with a DC solenoid actuator and are therefore hum-free. The noise during switching is barely audible making it beneficial for use in buildings such as hospitals, hotels or houses. An incorporated varistor protects the coil against remote lightning strikes and overvoltages up to 5kV. In addition, it limits the interference voltage peaks of the solenoid system.

The contactors can therefore be combined with programmable logic controllers. There is no need for a protective circuit. The solenoid system is provided with radio interference suppression. Accessories are available, such as auxiliary contacts and sealing covers.

**Advantages:**

- Powerful for lamp switching
- Operation flag indicator
- DC coil: - Noiseless and hum free
  - Low power consumption
  - Integrated overvoltage protection.

The EN contactors have a built-in toggle switch for automatic and manual operation.

**Advantages:**

- Facilitate commissioning
- Functional test before start-up
- Ease maintenance operation
- High degree of safety and availability in case of automation system failure.

4 Shopping centers | 5 Hospitals | 6 Commercial & industrial buildings

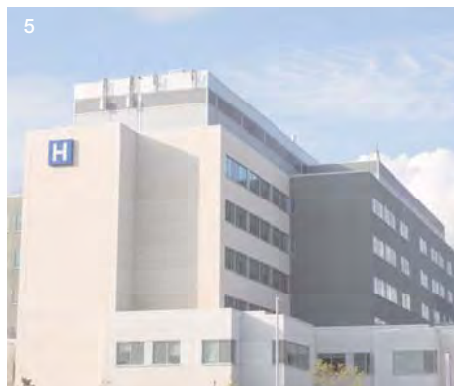
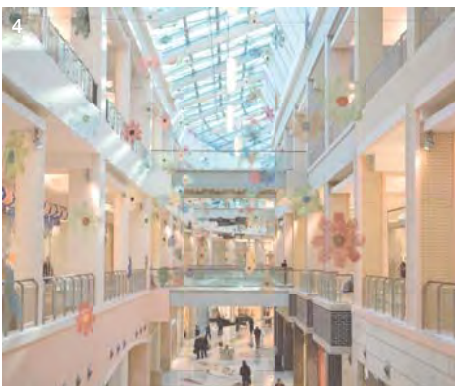



**20 A**  
**AC-1/AC-7a**

# ESB 20 Installation Contactors

AC Operated



## Application

The ESB contactors are used mainly in buildings for switching and controlling lighting, heating, ventilation and pumps. They are part of the complete range of Din rail products and can be integrated easily in dedicated panels.

## Certifications and Approvals



## Description

The **ESB 20** contactors are used for the control of single phase loads up to 20 A. They operate with an AC coil. You can choose between a various N.O. and N.C. contacts combination.

## Ordering Details

Main poles	Nb of modules	Control coil voltage		Type	Order code	Pack <sup>(ing)</sup> pieces	Weight kg (1 pce)	
		50 Hz	60 Hz					
 1	1	12 V	14 V	ESB 20-20	<b>GHE 321 1102 R1004</b>	10	0.14	
		20 V	24 V		<b>GHE 321 1102 R1005</b>	10	0.14	
		24 V	28 V		<b>GHE 321 1102 R0001</b>	10	0.14	
		42 V	48 V		<b>GHE 321 1102 R0002</b>	10	0.14	
		48 V	55 V		<b>GHE 321 1102 R0003</b>	10	0.14	
		110 V	125...127 V		<b>GHE 321 1102 R0004</b>	10	0.14	
		230 V	264 V		<b>GHE 321 1102 R0006</b>	10	0.14	
 2 N.O.	1	240 V	278 V	ESB 20-02	<b>GHE 321 1102 R0005</b>	10	0.14	
		400 V	-		<b>GHE 321 1102 R0007</b>	10	0.14	
		12 V	14 V		ESB 20-02	<b>GHE 321 1202 R1004</b>	10	0.14
		20 V	24 V			<b>GHE 321 1202 R1005</b>	10	0.14
		24 V	28 V			<b>GHE 321 1202 R0001</b>	10	0.14
		42 V	48 V			<b>GHE 321 1202 R0002</b>	10	0.14
		48 V	55 V			<b>GHE 321 1202 R0003</b>	10	0.14
110 V	125...127 V	<b>GHE 321 1202 R0004</b>	10	0.14				
230 V	264 V	<b>GHE 321 1202 R0006</b>	10	0.14				
 2 N.C.	1	240 V	278 V	ESB 20-11	<b>GHE 321 1202 R0005</b>	10	0.14	
		400 V	-		<b>GHE 321 1202 R0007</b>	10	0.14	
		12 V	14 V		ESB 20-11	<b>GHE 321 1302 R1004</b>	10	0.14
		20 V	24 V			<b>GHE 321 1302 R1005</b>	10	0.14
		24 V	28 V			<b>GHE 321 1302 R0001</b>	10	0.14
		42 V	48 V			<b>GHE 321 1302 R0002</b>	10	0.14
		48 V	55 V			<b>GHE 321 1302 R0003</b>	10	0.14
110 V	125...127 V	<b>GHE 321 1302 R0004</b>	10	0.14				
230 V	264 V	<b>GHE 321 1302 R0006</b>	10	0.14				
 1 N.O. 1 N.C.	1	240 V	278 V	ESB 20-11	<b>GHE 321 1302 R0005</b>	10	0.14	
		400 V	-		<b>GHE 321 1302 R0007</b>	10	0.14	
		12 V	14 V		ESB 20-11	<b>GHE 321 1302 R1004</b>	10	0.14
		20 V	24 V			<b>GHE 321 1302 R1005</b>	10	0.14
		24 V	28 V			<b>GHE 321 1302 R0001</b>	10	0.14
		42 V	48 V			<b>GHE 321 1302 R0002</b>	10	0.14
		48 V	55 V			<b>GHE 321 1302 R0003</b>	10	0.14
110 V	125...127 V	<b>GHE 321 1302 R0004</b>	10	0.14				
230 V	264 V	<b>GHE 321 1302 R0006</b>	10	0.14				

## Main Technical Data

For complete technical data see 1SBC103005S0201.pdf

<b>Main poles</b> acc to. IEC 60947-4-1 and IEC 61095	Rated operational voltage $U_e$	250 V
	$I_e$ AC-1 / AC-7a Rated operational current (for air temperature close to contactor $\theta \leq 55^\circ\text{C}$ )	20 A
	AC-3 / AC-7b Ratings (for air temperature close to contactor $\theta \leq 55^\circ\text{C}$ )	
	Rated operational power 1 phase	230 V 1.1 kW
	$I_e$ Rated operational current 1 phase	230 V 9 A
<b>Magnet system</b>	Coil operating limits (acc. to IEC 60947-4-1)	0.85 ... 1.1 $U_e$ (at $\theta \leq 55^\circ\text{C}$ )
	Average pull-in coil consumption value	8 VA / 5 W
	Average holding coil consumption value	3.2 VA / 1.2 W
<b>Connecting capacity</b>	Main pole terminals	Rigid 1 x 1.5 ... 10 mm <sup>2</sup> 2 x 1.5 ... 4 mm <sup>2</sup>
	Coil terminals	Rigid 1 x 0.5 ... 4 mm <sup>2</sup> 2 x 0.75 ... 2.5 mm <sup>2</sup>

Mounting positions

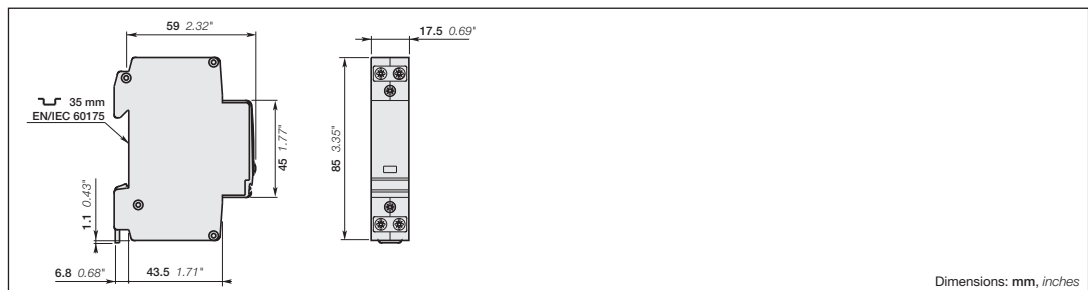
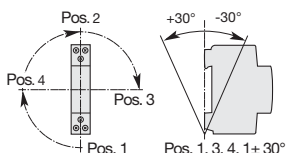



**24 A**  
**AC-1/AC-7a**

# ESB 24 Installation Contactors

AC/DC Operated



## Application

The ESB contactors are used mainly in buildings for switching and controlling lighting, heating, ventilation and pumps. They are part of the complete range of Din rail products and can be integrated easily in dedicated panels.

## Description

The **ESB 24** contactors are used for the control of single and three-phases loads up to 24 A. Due to their DC solenoid actuator, the **ESB 24** can be connected to AC or DC voltages.

This provides the following benefits:

Hum-free operating system, no vibration, silent in operation, low power consumption, integrated high overvoltage protection 5 kV. You can choose between a various N.O. and N.C. contacts combination.

## Main accessories:

Auxiliary contact blocks **EH04**.

## Certifications and Approvals



## Ordering Details

Main poles	Nb of modules	Control coil voltage		Type	Order code	Pack <sup>(ing)</sup> pieces	Weight kg (1 pce)
		40... 450 Hz	DC				
 4 N.O.	2	12 V	12 V	ESB 24-40	<b>GHE 329 1102 R 1004</b>	5	0.28
		24 V	24 V		<b>GHE 329 1102 R 0001</b>	5	0.28
		42 V	42 V		<b>GHE 329 1102 R 0002</b>	5	0.28
		48 V	48 V		<b>GHE 329 1102 R 0003</b>	5	0.28
		110...120 V	110...120 V		<b>GHE 329 1102 R 0004</b>	5	0.28
		230...240 V	230...240 V		<b>GHE 329 1102 R 0006</b>	5	0.28
		400...415 V	400...415 V		<b>GHE 329 1102 R 0007</b>	5	0.28
 4 N.C.	2	12 V	12 V	ESB 24-04	<b>GHE 329 1202 R 1004</b>	5	0.28
		24 V	24 V		<b>GHE 329 1202 R 0001</b>	5	0.28
		42 V	42 V		<b>GHE 329 1202 R 0002</b>	5	0.28
		48 V	48 V		<b>GHE 329 1202 R 0003</b>	5	0.28
		110...120 V	110...120 V		<b>GHE 329 1202 R 0004</b>	5	0.28
		230...240V	230...240V		<b>GHE 329 1202 R 0006</b>	5	0.28
		400...415 V	400...415 V		<b>GHE 329 1202 R 0007</b>	5	0.28
 2 N.O. 2 N.C.	2	12 V	12 V	ESB 24-22	<b>GHE 329 1302 R 1004</b>	5	0.28
		24 V	24 V		<b>GHE 329 1302 R 0001</b>	5	0.28
		42 V	42 V		<b>GHE 329 1302 R 0002</b>	5	0.28
		48 V	48 V		<b>GHE 329 1302 R 0003</b>	5	0.28
		110...120 V	110...120 V		<b>GHE 329 1302 R 0004</b>	5	0.28
		230...240 V	230...240 V		<b>GHE 329 1302 R 0006</b>	5	0.28
		400...415 V	400...415 V		<b>GHE 329 1302 R 0007</b>	5	0.28
 3 N.O. 1 N.C.	2	12 V	12 V	ESB 24-31	<b>GHE 329 1602 R 1004</b>	5	0.28
		24 V	24 V		<b>GHE 329 1602 R 0001</b>	5	0.28
		42 V	42 V		<b>GHE 329 1602 R 0002</b>	5	0.28
		48 V	48 V		<b>GHE 329 1602 R 0003</b>	5	0.28
		110...120 V	110...120 V		<b>GHE 329 1602 R 0004</b>	5	0.28
		230...240 V	230...240 V		<b>GHE 329 1602 R 0006</b>	5	0.28
		400 ...415 V	400 ...415 V		<b>GHE 329 1602 R 0007</b>	5	0.28
 1 N.O. 3 N.C.	2	12 V	12 V	ESB 24-13	<b>GHE 329 1702 R 1004</b>	5	0.28
		24 V	24 V		<b>GHE 329 1702 R 0001</b>	5	0.28
		42 V	42 V		<b>GHE 329 1702 R 0002</b>	5	0.28
		48 V	48 V		<b>GHE 329 1702 R 0003</b>	5	0.28
		110...120 V	110...120 V		<b>GHE 329 1702 R 0004</b>	5	0.28
		230...240 V	230...240 V		<b>GHE 329 1702 R 0006</b>	5	0.28
		400 ... 415 V	400 ... 415 V		<b>GHE 329 1702 R 0007</b>	5	0.28

## Main Technical Data

For complete technical data see 1SBC103005S0201.pdf

<b>Main poles</b>	Rated operational voltage $U_e$	400 V
acc to. IEC 60947-4-1 and IEC 61095	$I_e$ AC-1 / AC-7a Rated operational current (for air temperature close to contactor $\theta \leq 55^\circ\text{C}$ )	24 A
	AC-3 / AC-7b Ratings (for air temperature close to contactor $\theta \leq 55^\circ\text{C}$ )	
	Rated operational power	3 phases 400 V 4 kW
	$I_e$ Rated operational current	3 phases 400 V 9 A
<b>Magnet system</b>	Coil operating limits (acc. to IEC 60947-4-1)	0.85 ... 1.1 $U_e$ (at $\theta \leq 55^\circ\text{C}$ )
	Average pull-in coil consumption value	4 VA / 4 W
	Average holding coil consumption value	4 VA / 4 W
<b>Connecting capacity</b>	Main pole terminals	Rigid 1 x 1.5 ... 10 mm <sup>2</sup> 2 x 1.5 ... 4 mm <sup>2</sup>
	Coil terminals	Rigid 1 x 1 ... 4 mm <sup>2</sup> 2 x 0.75 ... 2.5 mm <sup>2</sup>

## Mounting positions

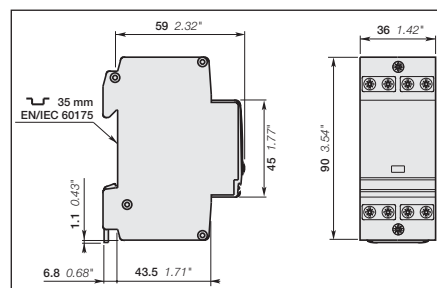
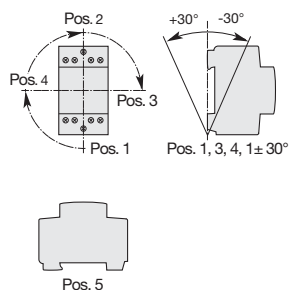

Dimensions: mm, inches



**40 A**  
**AC-1/AC-7a**

# ESB 40 Installation Contactors

AC/DC Operated



## Application

The ESB contactors are used mainly in buildings for switching and controlling lighting, heating, ventilation and pumps. They are part of the complete range of Din rail products and can be integrated easily in dedicated panels.

## Description

The **ESB 40** contactors are used for the control of single and three-phases loads up to 40 A. Due to their DC solenoid actuator, the **ESB 40** can be connected to AC or DC voltages. This provides the following benefits:

Hum-free operating system, no vibration, silent in operation, low power consumption, integrated high overvoltage protection 5 kV. You can choose between a various N.O. and N.C. contacts combination.

## Main accessories:

Auxiliary contact blocks **EH04**.

## Certifications and Approvals



## Ordering Details

Main poles	Nb of modules	Control coil voltage		Type	Order code	Pack <sup>(ing)</sup> pieces	Weight kg (1 pce)
		40... 450 Hz	DC				
 4 N.O.	3	12 V	12 V	ESB 40-40	<b>GHE 349 1102 R 1004</b>	3	0.40
		24 V	24 V		<b>GHE 349 1102 R 0001</b>	3	0.40
		42 V	42 V		<b>GHE 349 1102 R 0002</b>	3	0.40
		48 V	48 V		<b>GHE 349 1102 R 0003</b>	3	0.40
		110...120 V	110...120 V		<b>GHE 349 1102 R 0004</b>	3	0.40
		230...240 V	230...240 V		<b>GHE 349 1102 R 0006</b>	3	0.40
 2 N.O. 2 N.C.	3	400...415 V	400...415 V	ESB 40-22	<b>GHE 349 1102 R 0007</b>	3	0.40
		415 V	415 V		<b>GHE 349 1102 R 0008</b>	3	0.40
		24 V	24 V		<b>GHE 349 1302 R 0001</b>	3	0.40
		230 V	230 V		<b>GHE 349 1302 R 0006</b>	3	0.40
 3 N.O. 1 N.C.	3	24 V	24 V	ESB 40-31	<b>GHE 349 1602 R 0001</b>	3	0.40
		230 V	230 V		<b>GHE 349 1602 R 0006</b>	3	0.40
 3 N.O.	3	24 V	24 V	ESB 40-30	<b>GHE 349 1502 R 0001</b>	3	0.39
		230 V	230 V		<b>GHE 349 1502 R 0006</b>	3	0.39
		400 V	400 V		<b>GHE 349 1502 R 0007</b>	3	0.39
 3 N.O. 2 N.O.	3	24 V	24 V	ESB 40-20	<b>GHE 349 1402 R 0001</b>	3	0.38
		230 V	230 V		<b>GHE 349 1402 R 0006</b>	3	0.38

## Main Technical Data

For complete technical data see 1SBC103005S0201.pdf

<b>Main poles</b>	Rated operational voltage $U_e$	400 V
acc to IEC 60947-4-1 and IEC 61095	$I_e$ AC-1 / AC-7a Rated operational current (for air temperature close to contactor $\theta \leq 55^\circ\text{C}$ )	40 A
	AC-3 / AC-7b Ratings (for 1500 r.p.m., 50 Hz or 1800 r.p.m., 60 Hz, 3-phase motors) (for air temperature close to contactor $\theta \leq 55^\circ\text{C}$ )	
	Rated operational power 3 phases	400 V 11 kW
	$I_e$ Max. Rated operational current 3 phases	400 V 22 A
<b>Magnet system</b>	Coil operating limits (acc. to IEC 60947-4-1)	0.85 ... 1.1 $U_e$ (at $\theta \leq 55^\circ\text{C}$ )
	Average pull-in coil consumption value	5 VA / 5 W
	Average holding coil consumption value	5 VA / 5 W
<b>Connecting capacity</b>	Main pole terminals	Rigid 1 x 1.5 ... 25 mm <sup>2</sup> 2 x 1.5 ... 10 mm <sup>2</sup>
	Coil terminals	Rigid 1 x 1 ... 4 mm <sup>2</sup> 2 x 0.75 ... 2.5 mm <sup>2</sup>

### Mounting positions

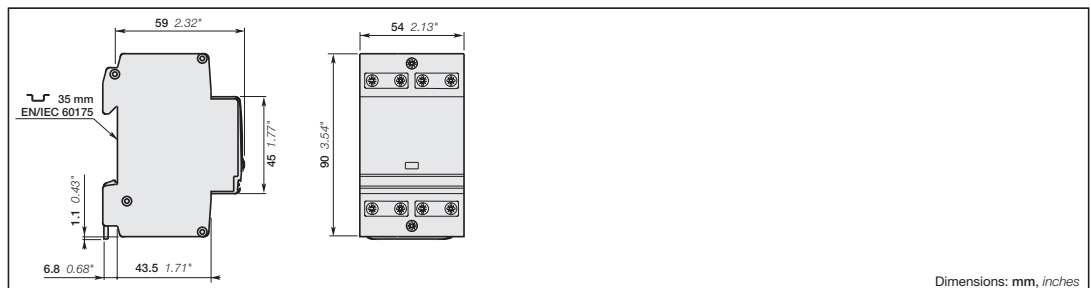
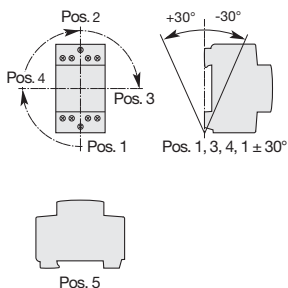

Dimensions: mm, inches



**63 A**  
**AC-1/AC-7a**

# ESB 63 Installation Contactors

AC/DC Operated



### Application

The ESB contactors are used mainly in buildings for switching and controlling lighting, heating, ventilation and pumps. They are part of the complete range of Din rail products and can be integrated easily in dedicated panels.

### Description

The **ESB 63** contactors are used for the control of single and three-phases loads up to 63 A. Due to their DC solenoid actuator, the **ESB 63** can be connected to AC or DC voltages. This provides the following benefits:

Hum-free operating system, no vibration, silent in operation, low power consumption, integrated high overvoltage protection 5 kV. You can choose between a various N.O. and N.C. contacts combination.

### Main accessories:

Auxiliary contact blocks **EH04**.

### Certifications and Approvals



### Ordering Details

Main poles	Nb of modules	Control coil voltage		Type	Order code	Pack <sup>(ing)</sup> pieces	Weight kg (1 pce)
		40... 450 Hz	DC				
 3 main poles, 4 N.O.	3	12 V	12 V	ESB 63-40	<b>GHE 369 1102 R 1004</b>	3	0.42
		24 V	24 V		<b>GHE 369 1102 R 0001</b>	3	0.42
		42 V	42 V		<b>GHE 369 1102 R 0002</b>	3	0.42
		48 V	48 V		<b>GHE 369 1102 R 0003</b>	3	0.42
		110...120 V	110...120 V		<b>GHE 369 1102 R 0004</b>	3	0.42
		230...240 V	230...240 V		<b>GHE 369 1102 R 0006</b>	3	0.42
 3 main poles, 2 N.O., 2 N.C.	3	400...415 V	400...415 V	ESB 63-22	<b>GHE 369 1102 R 0007</b>	3	0.42
		415 V	415 V		<b>GHE 369 1102 R 0008</b>	3	0.42
		400 V	400 V		<b>GHE 369 1302 R 0007</b>	3	0.42
 3 main poles, 3 N.O.	3	110 V	110 V	ESB 63-31	<b>GHE 369 1602 R 0004</b>	3	0.42
		230 V	230 V		<b>GHE 369 1602 R 0006</b>	3	0.42
 3 main poles, 3 N.O., 1 N.C.	3	230 V	230 V	ESB 63-30	<b>GHE 369 1502 R 0006</b>	3	0.41
		400 V	400 V		<b>GHE 369 1502 R 0007</b>	3	0.41
 3 main poles, 3 N.O.	3	24 V	24 V	ESB 63-20	<b>GHE 369 1402 R 0001</b>	3	0.40
		230 V	230 V		<b>GHE 369 1402 R 0006</b>	3	0.40
 3 main poles, 2 N.O., 1 N.C.	3	230 V	230 V	ESB 63-11	<b>GHE 369 1802 R 0006</b>	3	0.40
		1 N.O., 1 N.C.					

### Main Technical Data

For complete technical data see 1SBC103005S0201.pdf

<b>Main poles</b>	Rated operational voltage <b>U<sub>e</sub></b>	400 V
	acc to IEC 60947-4-1 and IEC 61095	<b>I<sub>e</sub> AC-1 / AC-7a Rated operational current</b> (for air temperature close to contactor $\theta \leq 55^\circ\text{C}$ )
<b>Magnet system</b>	<b>I<sub>e</sub> AC-3 / AC-7b Ratings</b> (for 1500 r.p.m., 50 Hz or 1800 r.p.m., 60 Hz, 3-phase motors) (for air temperature close to contactor $\theta \leq 55^\circ\text{C}$ )	63 A
	Rated operational power	3 phases 400 V 15 kW
	<b>I<sub>h</sub> Max. rated operational current</b>	3 phases 400 V 30 A
<b>Connecting capacity</b>	Coil operating limits (acc. to IEC 60947-4-1)	0.85 ... 1.1 <b>U<sub>e</sub></b> (at $\theta \leq 55^\circ\text{C}$ )
	Average pull-in coil consumption value	65 VA / 65 W
	Average holding coil consumption value	4.2 VA / 4.2 W
<b>Coil terminals</b>	Main pole terminals	Rigid 1 x 1.5 ... 25 mm <sup>2</sup>
		2 x 1.5 ... 10 mm <sup>2</sup>
		1 x 1 ... 4 mm <sup>2</sup>
	Coil terminals	Rigid 2 x 0.75 ... 2.5 mm <sup>2</sup>

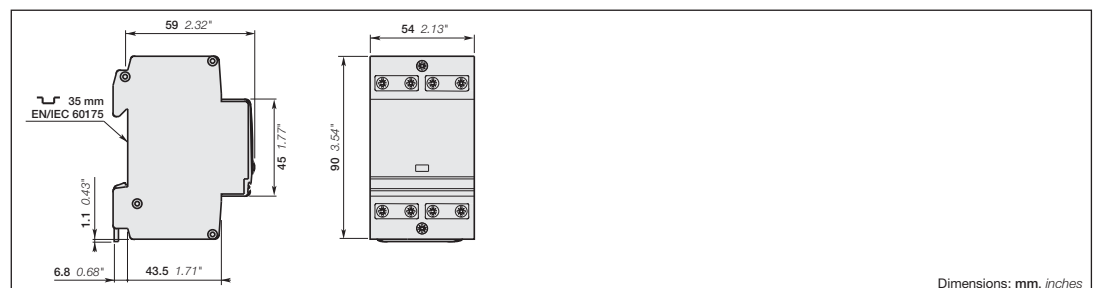
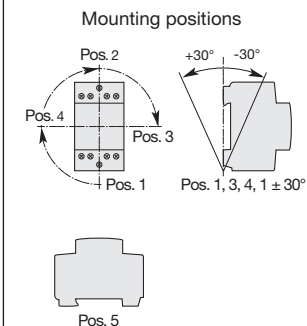



# ESB Installation Contactors

## Technical Data

### Main Pole - Utilization Characteristics according to IEC

Contactor types:	AC operated AC/DC operated	ESB20	ESB24	ESB40	ESB63
<b>Rated operational voltage <math>U_e</math> max.</b>	<b>V</b>	250	400		
<b>Rated frequency limits</b>	<b>Hz</b>	50/60	40...450		
<b>Utilization category AC-1 / AC-7a</b>					
for air temperature close to contactor < 55 °C					
<b>Max. rated operational current <math>I_e</math> AC-1 / AC-7a</b>	<b>A</b>	20	24	40	63
<b>Rated operational power AC-1</b>					
230 V - 1 phase	<b>kW</b>	4	5.3	8.8	13.8
400 V - 3 phases	<b>kW</b>	-	16	26	41
<b>Utilization category AC-3 / AC-7b</b>					
for air temperature close to contactor $\leq$ 55 °C					
<b>Max. rated operational current <math>I_e</math> AC-3/AC-7b</b>					
230 V - 1 phase	<b>A</b>	9	9	22	30
400 V - 3 phases	<b>A</b>	-	9	22	30
<b>Rated operational power AC-3</b>					
230 V - 1 phase	<b>kW</b>	1.1	2.2	5.5	8
400 V - 3 phases	<b>kW</b>	-	4	11	15
<b>Rated making capacity AC-3</b>					
10 x $I_e$ / AC-3					
<b>Rated breaking capacity AC-3</b>					
8 x $I_e$ / AC-3					
<b>Short-circuit protection</b> for contactors					
gG type fuse					
	<b>A</b>	20	35	63	80
<b>Rated short-time withstand current <math>I_{cw}</math></b>					
at 40 °C ambient temp., in free air, from a cold state					
	10 s <b>A</b>	72		176	240
<b>Heat dissipation per pole <math>I_e</math>/AC-1/AC-7a</b>					
	<b>W</b>	1	1.5	3	6
<b>Max. electrical switching frequency</b>					
- for AC-1 / AC-7a	<b>cycles/h</b>	300			
- for AC-3 / AC-7b	<b>cycles/h</b>	600			
<b>Electrical durability</b>					
- for AC-1 / AC-7a	<b>cycles</b>	150000	150000	150000	150000
- for AC-3 / AC-7b	<b>cycles</b>	150000	500000	170000	240000
<b>Mechanical durability</b>					
- millions of operating cycles		1			



# ESB Installation Contactors

## Technical Data

### Main Pole - Utilization Characteristics according to UL/CSA

Contactor types:	AC operated	ESB20	ESB24	ESB40	ESB63
	AC/DC operated				
<b>General use rating</b>					
<b>Amp rating</b>	240 V <b>A</b>	20	24	40	63
<b>Motor rating</b>					
<b>Amp rating</b>					
	120 V - 1 phase <b>A</b>	9.8	-	-	-
	240 V - 1 phase <b>A</b>	8	17	40	55
	440 - 480 V - 3 phases <b>V</b>	-	14	34	34
<b>Motor power</b>					
	120 V - 1 phase <b>hp</b>	1/2	-	-	-
	240 V - 1 phase <b>hp</b>	1	3	7.5	10
	440 - 480 V - 3 phases <b>V</b>	-	5	15	15
<b>Short-circuit protection</b> for contactors without thermal O/L relay - Motor protection excluded					
<b>Fuse rating</b>	<b>A</b>	25	25	40	75
<b>Fuse type, 600 V</b>		-	-	-	-
<b>Max. electrical switching frequency</b>					
- for general use	<b>cycles/h</b>	300			
- for motor use	<b>cycles/h</b>	600			

### General Technical Data

<b>Rated insulation voltage <math>U_i</math></b>			
according to IEC 60947-4-1	<b>V</b>	400	500
according to UL/CSA	<b>V</b>	240	600
<b>Rated impulse withstand voltage <math>U_{imp.}</math></b>	<b>kV</b>	6	
<b>Standards</b> IEC 60947-4-1 / EN 60947-4-1 and IEC 61095 / EN 61095, UL 508, CSA C22.2 N°14-05			
<b>Air temperature</b> close to contactor			
- for operation at $0.85 \dots 1.1 U_c$	<b>°C</b>	-25 ... +55 (Type ESB 24...63: for ambient temperature > 40°C, add ESB-DIS (1/2 module) at every second contactor)	
- for storage	<b>°C</b>	-40 ... +80	
<b>Climatic withstand</b>		IEC 60068-2-30, UTE 63-100 execution 1*	
<b>Operating altitude</b>	<b>m</b>	≤ 2000	
<b>Shock withstand</b>		10 g / 4 ms / axes X Y Z	
<b>Mounting positions</b>			
Pos 1, 3, 4, 1±30°			
Pos 5 : not allowed for ESB20			
<b>Fixing</b>			
on rail acc. to IEC 60715 and EN 60715			

\* ESB20 only







# ESB Installation Contactors

## Technical Data

### Magnet System Characteristics

Contactor types:	AC operated AC/DC operated	ESB20				ESB24		ESB40		ESB63	
<b>Rated operational voltage <math>U_e</math> max.</b>											
	- at 50 Hz	V	12 ... 400		12 ... 415		24 ... 415		24 ... 415		
	- at 60 Hz	V	14 ... 380		12 ... 415		24 ... 415		24 ... 415		
	- at 400 Hz	V	-		12 ... 415		24 ... 415		24 ... 415		
	DC	V	-		12 ... 415		24 ... 415		24 ... 415		
<b>Coil operating limits</b> acc. to IEC 60947-4-1			0.85 ... 1.1 x $U_c$ (at $\theta \leq 55$ °C)								
<b>Drop-out voltage in % of <math>U_c</math></b>			approx. 20 ... 75 %		approx. 20 ... 70 %						
<b>Frequency range</b>		Hz	50/60		40 ... 450						
<b>Coil consumption</b>											
Average pull-in value		VA/W	8 / 5		4 / 4		5 / 5		65 / 65		
Average holding value		VA/W	3.2 / 1.2		4 / 4		5 / 5		4.2 / 4.2		
<b>Operating time</b>											
between coil energization and:											
- N.O. contact closing		ms	12		40						
between coil de-energization and:											
- N.O. contact opening		ms	12		40						

### Connecting Characteristics

Contactor types:	AC operated AC/DC operated	ESB20				ESB24		ESB40		ESB63	
<b>Connecting capacity</b> (min. ... max.)											
Main pole terminals											
Rigid		1 x mm <sup>2</sup>	1.5 ... 10				1.5 ... 25				
		2 x mm <sup>2</sup>	1.5 ... 4				1.5 ... 10				
Capacity acc. to UL/CSA		AWG	14-8		16-8		16-4				
<b>Coil terminals</b>											
Rigid		1 x mm <sup>2</sup>	0.5 ... 4		1 ... 4						
		2 x mm <sup>2</sup>	0.75 ... 2.5								
Capacity acc. to UL/CSA		AWG	18-14		16-10						
<b>Degree of protection</b>											
acc. to IEC 60947-1 / EN 60947-1 and IEC 60529 / EN 60529											
Protection against direct contact in acc. with EN 50274											
All terminals			IP20								
<b>Screwdriver type</b>											
Main poles			Flat Ø 5 / Pozidriv 1				Flat Ø 7.5 / Pozidriv 2				
Coil terminals			Flat Ø 5 / Pozidriv 1				Flat Ø 5 / Pozidriv 1				
<b>Stripping length</b>											
Main poles		mm	10				13				
Coil terminals		mm	7								
<b>Tightening torque</b>											
Main poles		Nm	1.2		1		2.5				
Coil terminals		Nm	0.9								



# ESB Installation Contactors

## Technical Data

### EH04... Auxiliary Contact Block - Utilization Characteristics according to IEC

Contactor types:	AC operated AC/DC operated	ESB20	ESB24	ESB40	ESB63
Rated operational voltage $U_e$ max.	V	-	500		
Conventional free air thermal current $I_{th}$ $\theta \leq 40^\circ\text{C}$	A	-	6		
Rated frequency limits	Hz	-	50/60		
Rated operational current $I_e$ / AC-15					
acc. to IEC 60947-5-1	240 V 50/60 Hz	A	4		
	415 V 50/60 Hz	A	3		
	500 V 50/60 Hz	A	2		
Making capacity acc. to IEC 60947-5-1		-	11 x $I_e$ AC-15		
Breaking capacity acc. to IEC 60947-5-1		-	11 x $I_e$ AC-15		
Short-circuit protection gl type fuse	A	-	10		
Minimum switching capacity with failure rate acc. to IEC 60947-5-4	V/mA	-	17 / 5		
Heat dissipation per pole at 6 A	W	-	0.1		

### Electrical durability

AC-1 / 400 V / 3-phase for ESB 20, 24, 40, 63

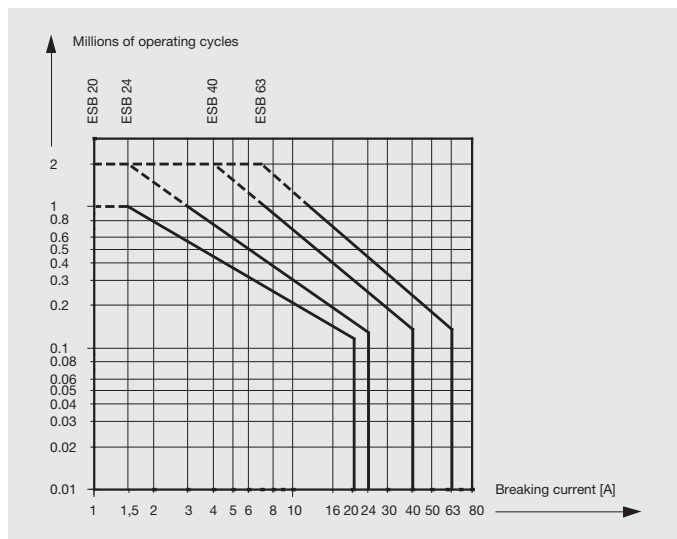

AC-3 / 400 V / 3-phase for ESB 24, 40, 63

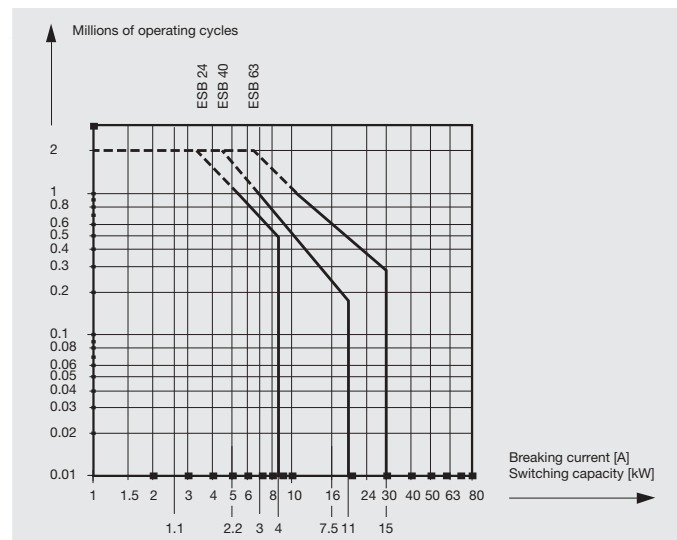



# ESB Installation Contactors

## Technical Data

### DC-1/DC-3 switching DC with N.O. contacts (N.O.)

Type	Rated operating voltage $U_e$	DC-1 ( $L/R \leq 1 \text{ ms}$ )			DC-3 ( $L/R \leq 2 \text{ ms}$ )		
		1 current path	2 current paths in series	3 current paths in series	1 current path	2 current paths in series	3 current paths in series
ESB 20-20	24 V DC	20 A	20 A	-	15 A	20 A	-
	48 V DC	15 A	20 A	-	7 A	15 A	-
	60 V DC	15 A	20 A	-	5 A	10 A	-
	110 V DC	5 A	15 A	-	1.5 A	5 A	-
	220 V DC	0.5 A	5 A	-	0.2 A	1.5 A	-
ESB 24	24 V DC	24.0 A	24.0 A	24.0 A	16.0 A	24.0 A	24.0 A
	48 V DC	21.0 A	24.0 A	24.0 A	8.0 A	18.0 A	24.0 A
	60 V DC	17.0 A	24.0 A	24.0 A	4.0 A	14.0 A	24.0 A
	110 V DC	7.0 A	16.0 A	24.0 A	1.6 A	6.5 A	16.0 A
	220 V DC	0.9 A	4.5 A	13.0 A	0.2 A	1.0 A	4.0 A
ESB 40	24 V DC	40.0 A	40.0 A	40.0 A	19.0 A	40.0 A	40.0 A
	48 V DC	23.0 A	40.0 A	40.0 A	10.0 A	20.0 A	40.0 A
	60 V DC	18.0 A	32.0 A	40.0 A	5.0 A	16.0 A	34.0 A
	110 V DC	8.0 A	17.0 A	30.0 A	1.8 A	7.0 A	18.0 A
	220 V DC	1.0 A	5.0 A	15.0 A	0.3 A	1.1 A	4.5 A
ESB 63	24 V DC	50.0 A	63.0 A	63.0 A	21.0 A	44.0 A	63.0 A
	48 V DC	25.0 A	43.0 A	63.0 A	11.0 A	22.0 A	47.0 A
	60 V DC	20.0 A	35.0 A	60.0 A	5.5 A	18.0 A	38.0 A
	110 V DC	9.0 A	19.0 A	33.0 A	2.0 A	8.0 A	21.0 A
	220 V DC	1.1 A	5.5 A	17.0 A	0.3 A	1.2 A	5.0 A

### DC-1/DC-3 switching DC with N.C. contacts (N.C.)

Type	Rated operating voltage $U_e$	DC-1 ( $L/R \leq 1 \text{ ms}$ )			DC-3 ( $L/R \leq 2 \text{ ms}$ )		
		1 current path	2 current paths in series	3 current paths in series	1 current path	2 current paths in series	3 current paths in series
ESB 20-02	24 V DC	14 A	20 A	-	6 A	10 A	-
	48 V DC	7 A	14 A	-	3 A	6 A	-
	60 V DC	4.5 A	10 A	-	2 A	4 A	-
	110 V DC	1.5 A	4.4 A	-	0.6 A	1.8 A	-
	220 V DC	0.2 A	1.5 A	-	0.1 A	0.6 A	-
ESB 24	24 V DC	14.5 A	24.0 A	24.0 A	6.3 A	11.0 A	19.0 A
	48 V DC	7.5 A	12.5 A	22.0 A	3.1 A	5.4 A	9.4 A
	60 V DC	4.5 A	10.0 A	17.5 A	2.0 A	4.3 A	7.5 A
	110 V DC	1.6 A	4.4 A	9.5 A	0.7 A	1.9 A	4.1 A
	220 V DC	0.2 A	1.4 A	3.8 A	0.1 A	0.6 A	1.6 A



# ESB Installation Contactors - Lighting application

## Technical Data

### Switching of lamp load

The following table shows the number of lamps which can be connected per phase at 230 V, 50 Hz. Air temperature, near the contactor, must be limited to 55°C.

Please, note that the given capacitor load must not be exceeded, otherwise inadmissible high inrush current peaks could occur.

These are influenced by the length and cross section of the wire used, the type of power supply unit and specifications of the lamp brand.

For these reasons, values in the table are for information only.

Numbers are given for a 230V voltage distributed between phase and neutral: single phase (phase + neutral) or three-phases (3 phases + neutral), lamps are wired in star connection.

In the case of three-phase supply without neutral, 230V phase-to-phase, the permissible number of lamps per phase will be that given in the table multiplied by 0,58.

Lamp type	Lamp data		Permissible number of lamps per phase (230 V, 50 Hz)				Capacitor
	Watt	I <sub>n</sub> A	ESB 20	ESB 24	ESB 40	ESB 63	µF
Incandescent lamps	60	0.26	21	25	54	83	
	100	0.43	13	15	32	50	
	200	0.87	7	7	16	25	
	300	1.30	4	5	11	16	
	500	2.17	3	3	6	10	
	1000	4.35	1	1	3	5	
Fluorescent lamps Uncompensated and series compensation	15	0.33	40	30	100	155	
	20	0.37	37	26	85	135	
	40	0.43	32	20	65	105	
	42	0.54	26	16	52	85	
	58	0.64	21	12	40	65	
	65	0.67	21	12	40	65	
Two-lamp circuit	115	1.3	9	5	18	28	
	140	1.5	9	5	18	28	
	2 x 20	2 x 0.13	2 x 22	2 x 26	2 x 85	2 x 140	
	2 x 40	2 x 0.22	2 x 17	2 x 20	2 x 65	2 x 105	
	2 x 42	2 x 0.24	2 x 13	2 x 16	2 x 52	2 x 65	
	2 x 58	2 x 0.34	2 x 10	2 x 12	2 x 40	2 x 65	
Parallel compensation	2 x 65	2 x 0.34	2 x 10	2 x 12	2 x 40	2 x 65	
	2 x 115	2 x 0.65	2 x 4	2 x 5	2 x 18	2 x 28	
	2 x 140	2 x 0.75	2 x 4	2 x 5	2 x 18	2 x 28	
	15	0.11	16	8	16	67	4.5
	20	0.13	16	8	16	67	4.5
	40	0.22	16	8	16	67	4.5
High pressure mercury-vapor lamps Uncompensated	42	0.24	13	6	12	50	6
	58	0.34	11	5	10	43	7
	65	0.34	11	5	10	43	7
	115	0.65	4	2	4	17	18
	140	0.75	4	2	4	17	18
	50	0.61	30	14	36	50	
Parallel compensation	80	0.8	15	10	27	38	
	125	1.15	10	7	19	26	
	250	2.15	6	4	10	14	
	400	3.25	2	2	7	10	
	700	5.40	2	1	4	6	
	1000	7.5	1	1	3	4	
Parallel compensation	2000/400 V	8	-	1	3	4	
	50	0.28	4	5	10	43	7
	80	0.41	3	4	8	37	8
	125	0.65	2	3	6	26	10
	250	1.22	1	2	3	15	18
	400	1.95	-	1	3	10	25
Lamps with electronic power supply units	700	3.45	-	-	1	5	45
	1000	4.8	-	-	1	4	60
	2000/400 V	5.45	-	1	2	3	35
	1 x 18	-	15	24	55	76	
	2 x 18	-	8	18	34	48	
	1 x 36	-	12	16	34	47	
Halogen metal-vapor lamps Uncompensated	2 x 36	-	7	11	20	29	
	1 x 58	-	11	14	32	46	
	2 x 58	-	6	8	17	24	
	35	0.53	9	10	28	38	
	70	1	4	5	14	20	
	150	1.8	3	3	8	11	
Parallel compensation	250	3	1	2	5	7	
	400	3.5	1	1	4	6	
	1000	9.5	-	-	1	2	
	2000	16.5	-	-	1	1	
	2000/3500/400 V	10.5	-	-	2	2	
	3500/400 V	18	-	-	1	1	
Low pressure sodium-vapor lamps Uncompensated	35	0.25	-	5	11	30	6
	70	0.45	-	3	5	18	12
	150	0.75	-	1	3	9	20
	250	1.5	-	1	2	7	33
	400	2.5	-	-	2	6	35
	1000	5.8	-	-	-	2	95
Parallel compensation	2000	11.5	-	-	-	1	148
	2000/3500/400 V	6.6	-	-	1	2	58
	3500/400 V	11.6	-	-	-	1	100
	35	1.5	10	8	22	30	
	55	1.5	10	8	22	30	
	90	2.4	5	5	13	19	
Parallel compensation	135	3.5	3	3	10	13	
	150	3.3	3	3	10	14	
	180	3.3	3	3	10	14	
	200	2.3	3	5	14	20	
	35	0.31	-	1	4	15	20
	55	0.42	-	1	4	15	20
High pressure sodium-vapor lamps Uncompensated	90	0.63	-	1	3	10	30
	135	0.94	-	-	2	7	45
	150	1.0	-	-	2	8	40
	180	1.16	-	-	2	8	40
	200	1.32	-	1	3	12	25
	150	1.8	3	4	15	20	
Parallel compensation	250	3.0	2	3	9	15	
	330	3.7	1	2	8	10	
	400	4.7	-	1	6	8	
	1000	10.3	-	-	3	4	
	150	0.83	-	1	3	15	20
	250	1.5	-	1	2	9	33
Transformers for halogen low voltage lamps (12 or 24 V AC)	330	2.0	-	-	2	7	40
	400	2.4	-	-	1	6	48
	1000	6.3	-	-	-	2	106
	20		40	50	110	174	
	50		20	24	50	80	
	75		13	16	35	54	
Transformers for halogen low voltage lamps (12 or 24 V AC)	100		10	12	27	43	
	150		7	9	19	29	
	200		5	6	14	23	
	300		3	4	9	14	



**20 A**  
**AC-1/AC-7a**

# EN 20 Installation Contactors - Manually / Automatic operated

## AC Operated



### Application

The EN contactors are used mainly in buildings for switching and controlling lighting, heating, ventilation and pumps. They are part of the complete range of Din rail products and can be integrated easily in dedicated panels.

### Certifications and Approvals



### Description

The EN 20 contactors are used for the control of single phase loads up to 20 A. They operate with an AC coil.

**EN contactors** have a built-in toggle switch to select between three function modes:

Off position, automatic run (normal contactor function), manual override with a return to Auto the next time the coil is energized.

This offers many advantages as:

You can make functional test before installation start-up. It can be used for maintenance operation, to change lamps and test it. It provides higher safety and drop out as you can switch the application manually.

The toggle switch is also used for household application like water heating where double tariff of kWh is used.

### Ordering Details

Main poles	Nb of modules	Control coil voltage		Type	Order code	Pack <sup>(ing)</sup> pieces	Weight kg (1 pce)
		50 Hz	60 Hz				
 2 N.O.	1	24 V	28 V	EN 20-20	<b>GHE 322 1101 R0001</b>	10	0.14
		230 V	264 V		<b>GHE 322 1101 R0006</b>		

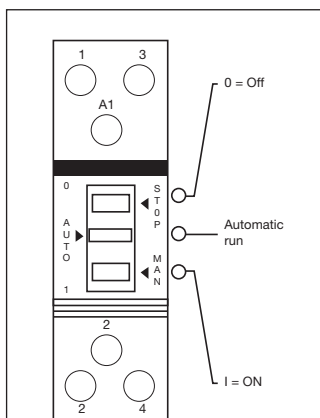

### Main Technical Data

For complete technical data see 1SBC103005S0201.pdf

<b>Main poles</b>	Rated operational voltage $U_e$	250 V
acc to. IEC 60947-4-1 and IEC 61095	$I_e$ AC-1 / AC-7a Rated operational current (for air temperature close to contactor $\theta \leq 55^\circ\text{C}$ )	20 A
	$P_e$ AC-1 Rated power	4 kW
<b>Magnet system</b>	Coil operating limits (acc. to IEC 60947-4-1)	0.85 ... 1.1 $U_e$ (at $\theta \leq 55^\circ\text{C}$ )
	Average pull-in coil consumption value	8 VA / 5 W
	Average holding coil consumption value	3.2 VA / 1.2 W
<b>Connecting capacity</b>	Main pole terminals	1 x 1.5 ... 10 mm <sup>2</sup> 2 x 1.5 ... 4 mm <sup>2</sup>
	Coil terminals	1 x 0.5 ... 4 mm <sup>2</sup> 2 x 0.75 ... 2.5 mm <sup>2</sup>

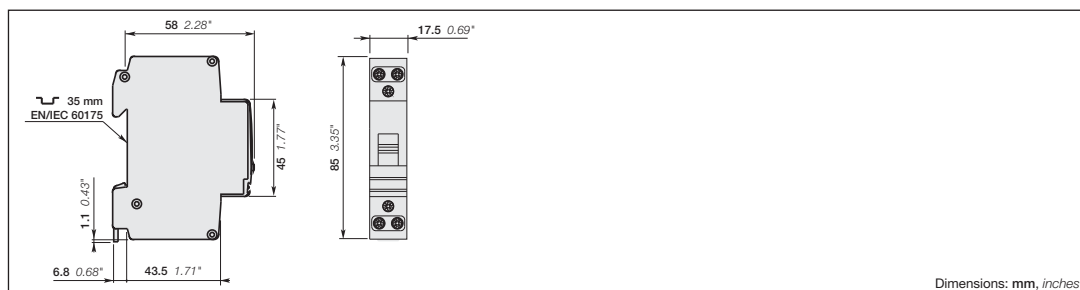
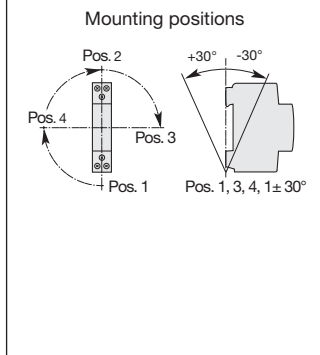



**24 A**  
**AC-1/AC-7a**

# EN 24 Installation Contactors - Manually / Automatic operated

AC /DC Operated



### Application

The EN contactors are used mainly in buildings for switching and controlling lighting, heating, ventilation and pumps. They are part of the complete range of Din rail products and can be integrated easily in dedicated panels.

### Certifications and Approvals



### Description

The EN 24 contactors are used for the control of single and three-phase loads up to 24 A. They operate with a DC coil. EN contactors have a built-in toggle switch to select between three function modes: Off position, automatic run (normal contactor function), manual Override with a return to Auto the next time the coil is energized.

This offers many advantages as:

You can make functional test before installation start-up, it can be used for maintenance operation, to change lamps and test it, it provide higher safety and drop out as you can switch the application manually. The toggle switch is also used for household application like water heating where double tariff of kWh is used.

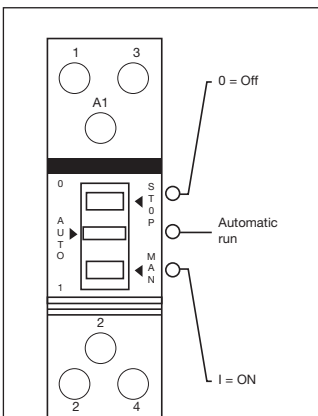

### Ordering Details

Main poles	Nb of modules	Control coil voltage		Type	Order code	Pack <sup>(in)</sup> pieces	Weight kg (1 pce)
		40...450 Hz	DC				
	2	24 V	24 V	EN 24-40	GHE 326 1101 R0001	5	0.24
		230/240 V	230/240 V				
	2	24 V	24 V	EN 24-31	GHE 326 1601 R0001	5	0.24
		230/240 V	230/240 V				
	2	230/240 V	230/240 V	EN 24-30	GHE 326 1501 R0006	5	0.23

### Main Technical Data

For complete technical data see 1SBC103005S0201.pdf

<b>Main poles</b> acc to IEC 60947-4-1 and IEC 61095	Rated operational voltage $U_e$	400 V
	$I_e$ AC-1 / AC-7a Rated operational current (for air temperature close to contactor $\theta \leq 55^\circ\text{C}$ )	24 A
	$P_e$ AC-1 Rated power	230 V: 5,3 kW 400 V: 16 kW
<b>Magnet system</b>	Coil operating limits (acc. to IEC 60947-4-1)	0.85 ... 1.1 $U_e$ (at $\theta \leq 55^\circ\text{C}$ )
	Average pull-in coil consumption value	4 VA / 4 W
	Average holding coil consumption value	4 VA / 4 W
<b>Connecting capacity</b>	Main pole terminals	Rigid 1 x 1.5 ... 10 mm <sup>2</sup> 2 x 1.5 ... 4 mm <sup>2</sup>
	Coil terminals	Rigid 1 x 1 ... 4 mm <sup>2</sup> 2 x 0.75 ... 2.5 mm <sup>2</sup>

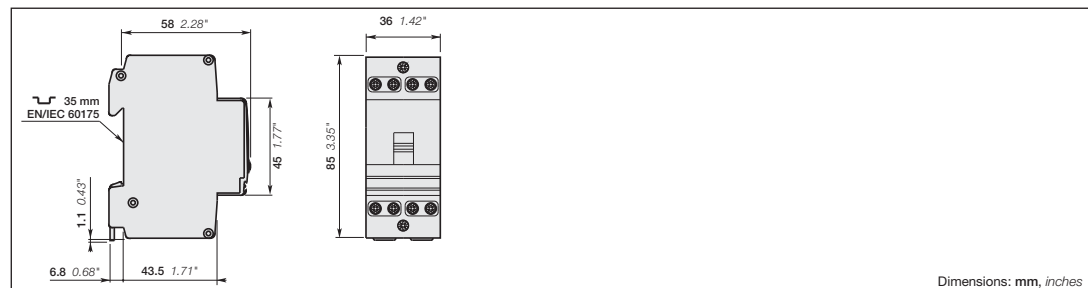
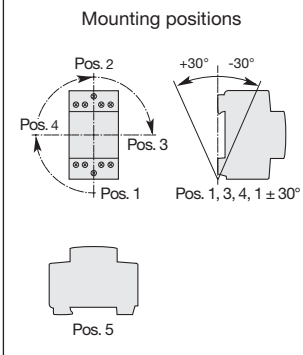

Dimensions: mm, inches



**40 A**  
**AC-1/AC-7a**

# EN 40 Installation Contactors - Manually / Automatic operated

AC /DC Operated



## Application

The EN contactors are used mainly in buildings for switching and controlling lighting, heating, ventilation and pumps. They are part of the complete range of Din rail products and can be integrated easily in dedicated panels.

## Description

The EN 40 contactors are used for the control of single and three-phase loads up to 40 A. They operate with a DC coil.

EN contactors have a built-in toggle switch to select between three function modes:

Off position, automatic run (normal contactor function), manual Override with a return to Auto the next time the coil is energized.

This offers many advantages as:

You can make functional test before installation start-up, it can be used for maintenance operation, to change lamps and test it, it provide higher safety and drop out as you can switch the application manually.

The toggle switch is also used for household application like water heating where double tariff of kWh is used.

## Certifications and Approvals

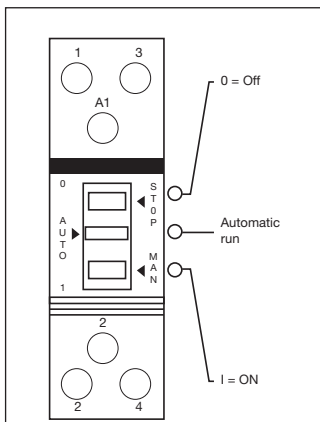

## Ordering Details

Main poles	Nb of modules	Control coil voltage		Type	Order code	Pack <sup>(ing)</sup> pieces	Weight kg (1 pce)
		40...450 Hz	DC				
 3 4 N.O.	3	24 V	24 V	EN 40-40	GHE 342 1101 R0001	3	0.41
		110 V	110 V		GHE 342 1101 R0004	3	0.41
		230/240 V	230/240 V		GHE 342 1101 R0006	3	0.41
 3 3 N.O. 1 N.C.	3	24 V	24 V	EN 40-31	GHE 342 1601 R0001	3	0.41
		230/240 V	230/240 V		GHE 342 1601 R0006	3	0.41
 3 3 N.O.	3	230/240 V	230/240 V	EN 40-30	GHE 342 1501 R0006	3	0.40
 3 2 N.O.	3	230/240 V	230/240 V	EN 40-20	GHE 342 1401 R0006	3	0.30

## Main Technical Data

For complete technical data see 1SBC103005S0201.pdf

<b>Main poles</b> acc to. IEC 60947-4-1 and IEC 61095	Rated operational voltage $U_e$	400 V
	$I_e$ AC-1 / AC-7a Rated operational current (for air temperature close to contactor $\theta \leq 55^\circ\text{C}$ )	40 A
	$P_e$ AC-1 Rated power	230 V 8.8 kW 400 V 26 kW
<b>Magnet system</b>	Coil operating limits (acc. to IEC 60947-4-1)	0.85 ... 1.1 $U_e$ (at $\theta \leq 55^\circ\text{C}$ )
	Average pull-in coil consumption value	5 VA / 5 W
	Average holding coil consumption value	5 VA / 5 W
<b>Connecting capacity</b>	Main pole terminals	Rigid 1 x 1.5 ... 25 mm <sup>2</sup> 2 x 1.5 ... 10 mm <sup>2</sup>
	Coil terminals	Rigid 1 x 1 ... 4 mm <sup>2</sup> 2 x 0.75 ... 2.5 mm <sup>2</sup>

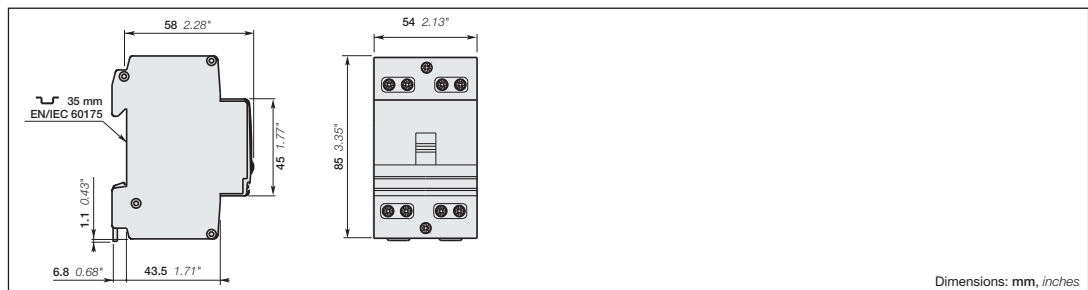
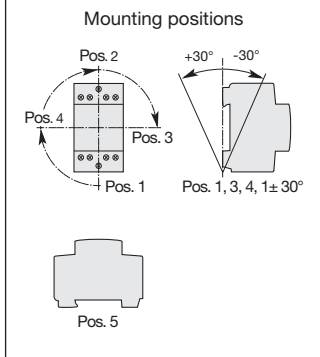



# EN Installation Contactors - Manually / Automatic operated

## Technical Data

### Main Pole - Utilization Characteristics according to IEC

Contactor types:	AC operated		EN20	EN24	EN40
	AC/DC operated				
<b>Rated operational voltage U<sub>e</sub> max.</b>	<b>V</b>		250	400	
<b>Rated frequency limits</b>	<b>Hz</b>		50/60	40... 450	
<b>Utilization category AC-1 / AC-7a</b> for air temperature close to contactor < 55 °C					
<b>Max. rated operational current I<sub>e</sub> AC-1 / AC-7a</b>	<b>A</b>		20	24	40
<b>Rated operational power AC-1</b>					
230 V - 1 phase	<b>kW</b>		4	5.3	8.8
400 V - 3 phase	<b>kW</b>		-	16	26
<b>Short-circuit protection</b> for contactors gG type fuse					
	<b>A</b>		20	35	63
<b>Rated short-time withstand current I<sub>cw</sub></b> at 40 °C ambient temp., in free air, from a cold state					
10 s	<b>A</b>		72		176
<b>Heat dissipation per pole I<sub>e</sub> / AC-1 / AC-7a</b>	<b>W</b>		1	1.5	3
<b>Max. electrical switching frequency</b> - for AC-1 / AC-7a					
	<b>cycles/h</b>		300		
<b>Electrical Durability</b> - for AC-1 / AC-7a					
	<b>cycles</b>		150000		
<b>Mechanical durability</b> - millions of operating cycles					
			1		

### General Technical Data

Contactor types:	AC operated		EN20	EN24	EN40
	AC/DC operated				
<b>Rated insulation voltage U<sub>i</sub></b> according to IEC 60947-4-1	<b>V</b>		400	500	
<b>Rated impulse withstand voltage U<sub>imp.</sub></b>	<b>kV</b>		6		
<b>Standards</b> IEC 60947-4-1 / EN 60947-4-1 and IEC 61095 / EN 61095					
<b>Air temperature</b> close to contactor - for operation at 0.85 ... 1.1 U <sub>c</sub>					
	<b>°C</b>		-25 ... +55 (Type EN 24...40: for ambient temperature > 40°C, add ESB-DIS (1/2 module) at every second contactor)		
- for storage	<b>°C</b>		-40 ... +80		
<b>Climatic withstand</b> IEC 60068-2-30, UTE 63-100 execution 1*					
<b>Operating altitude</b>	<b>m</b>		≤ 2000		
<b>Shock withstand</b> 10 g / 4 ms / axes X Y Z					
<b>Mounting positions</b> Pos 1, 3, 4, 1±30° Pos 5 : not allowed for EN20					
<b>Fixing</b> on rail acc. to IEC 60715 and EN 60715					

\* EN20 only



# EN Installation Contactors - Manually / Automatic operated

## Technical Data

### Magnet System Characteristics

Contactor types:	AC operated	EN20	EN24	EN40
	AC/DC operated			
<b>Rated operational voltage <math>U_e</math> max.</b>				
- at 50 Hz	V	12 ... 400	12 ... 415	24 ... 415
- at 60 Hz	V	14 ... 380	12 ... 415	24 ... 415
	V DC	-	12 ... 415	24 ... 415
<b>Coil operating limits</b> acc. to IEC 60947-4-1				
<b>Drop-out voltage in % of <math>U_c</math></b>		approx. 20 ... 75 %		
<b>Frequency range</b>		50/60		
<b>Coil consumption</b>				
Average pull-in value	VA/W	8 / 5	4 / 4	5 / 5
Average holding value	VA/W	3.2 / 1.2	4 / 4	5 / 5
<b>Operating time</b>				
between coil energization and:				
- N.O. contact closing	ms	12	40	
between coil de-energization and:				
- N.O. contact opening	ms	12	40	

### Connecting Characteristics

Contactor types:	EN20	EN24	EN40
<b>Connecting capacity</b> (min. ... max.)			
Main pole terminals			
Rigid	1 x mm <sup>2</sup>	1.5 ... 10	1.5 ... 25
	2 x mm <sup>2</sup>	1.5 ... 4	1.5 ... 10
Capacity acc. to <b>UL/CSA</b>		AWG	14 ... 8
			16 ... 8
			16 ... 4
<b>Coil terminals</b>			
Rigid	1 x mm <sup>2</sup>	0.5 ... 4	1 ... 4
	2 x mm <sup>2</sup>	0.75 ... 2.5	
Capacity acc. to <b>UL/CSA</b>		AWG	18 ... 14
			16 ... 10
<b>Degree of protection</b>			
acc. to IEC 60947-1 / EN 60947-1 and IEC 60529 / EN 60529			
Protection against direct contact in acc. with EN 50274			
All terminals		IP20	
<b>Screwdriver type</b>			
Main poles		Flat Ø 5 / Pozidriv 1	Flat Ø 7.5 / Pozidriv 2
Coil terminals		Flat Ø 5 / Pozidriv 1	Flat Ø 5 / Pozidriv 1
<b>Stripping length</b>			
Main poles	mm	10	13
Coil terminals	mm	7	
<b>Tightening torque</b>			
Main poles	Nm	1.2	2.5
Coil terminals	Nm	0.9	



# ESB/EN Installation Contactors

## Main Accessories

### Sealing cover



ESB-PLK 40/63



ESB-PLK 24

### Auxiliary Contact Blocks

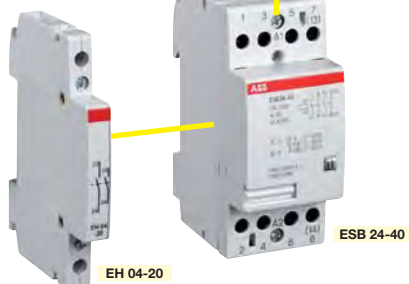

EH 04-20

ESB 24-40

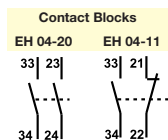

### Labelling material



SZ-KZS...

### Distance piece



ESB-DIS

## Ordering Details

### Auxiliary Contact Blocks

Contactor type	Contact blocks	Type	Order code	Pack <sup>(ing)</sup> pieces	Weight kg (1 pce)
ESB/EN 24, 40, 63	2 -	EH 04-20	GHE 340 1321 R0001	10	0.004
		EH 04-11	GHE 340 1321 R0002	10	0.004
	1 1				

### Sealing cover

Contactor type	Type	Order code	Pack <sup>(ing)</sup> pieces	Weight kg (1 pce)
ESB/EN 24	ESB-PLK 24	GHE 320 1903 R0001	10	0.002
ESB/EN 40, 63	ESB-PLK 40/63	GHE 340 1903 R0002	10	0.009

### Distance piece

Contactor type	Type	Order code	Pack <sup>(ing)</sup> pieces	Weight kg (1 pce)
ESB/EN 24, 40, 63	ESB-DIS	GHE 320 1902 R0001	10	0.002

### Labelling material

Contactor type	Type	Order code	Pack <sup>(ing)</sup> pieces	Weight kg (1 pce)
ESB/EN 20, 24, 40, 63				
Label - unlabelled*	SZ-KZS	GHS 210 1946 R0004	30	0.008
Label - numbering 1-40	SZ-KZS/1	GHS 210 1946 R0005	30	0.008
Label - numbering 2 * 1-20	SZ-KZS/6	GHS 210 1946 R0010	30	0.008
Label - numbering 4 * 1-10	SZ-KZS/9	GHS 210 1946 R0013	30	0.008
Label - numbering 4 * 11-20	SZ-KZS/10	GHS 210 1946 R0014	30	0.008
Label - labelled L1	SZ-KZS/11	GHS 210 1946 R0015	30	0.008
Label - labelled L2	SZ-KZS/12	GHS 210 1946 R0016	30	0.008
Label - labelled L3	SZ-KZS/13	GHS 210 1946 R0017	30	0.008

**Note:** \* The unlabelled can be labelled by water-resistant and permanent marker or by means of computer-controlled labelling system (plotter).  
Special labels on request: minimum quantities 50