

Drive^{IT} Low Voltage AC Drives

Installation Supplement ACS550-U2 Drives (150...550 HP)



ACS550 Drive Manuals

GENERAL MANUALS

ACS550-01/U1 User's Manual (0.75...90 kW) / (1...150 HP)

- Safety
- Installation
- Start-Up
- Diagnostics
- Maintenance
- Technical Data

ACS550-02/U2 User's Manual (110...355 kW) / (150...550 HP)

- Safety
- Installation
- Start-Up
- Diagnostics
- Maintenance
- Technical Data

ACS550 Technical Reference Manual

- Detailed Product Description
 - Technical product description including Dimensional drawings
 - Cabinet mounting information including power losses
 - Software and control including complete parameter descriptions
 - User interfaces and control connections
 - Complete options descriptions
 - Spare parts
 - Etc.
- Practical Engineering Guides
 - PID & PFC engineering guides
 - Dimensioning and sizing guidelines
 - Diagnostics and Maintenance information
 - Etc.

OPTION MANUALS

(Fieldbus Adapters, I/O Extension Modules etc., manuals delivered with optional equipment)

Relay Output Extension Module (typical title)

- Installation
- Start-Up
- Diagnostics
- Technical Data

Safety

Use of warnings and notes

There are two types of safety instructions throughout this manual:

- Notes draw attention to a particular condition or fact, or give information on a subject.
- Warnings caution you about conditions which can result in serious injury or death and/or damage to the equipment. They also tell you how to avoid the danger. The warning symbols are used as follows:



Dangerous voltage warning warns of high voltage which can cause physical injury and/or damage to the equipment.



General warning warns about conditions, other than those caused by electricity, which can result in physical injury and/or damage to the equipment.

Note: In this manual, ACS550 refers, unless otherwise stated, to type ACS550-U2.



WARNING! The ACS550 adjustable speed AC drive should ONLY be installed by a qualified electrician.



WARNING! Even when the motor is stopped, dangerous voltage is present at the Power Circuit terminals U1, V1, W1 and U2, V2, W2 and UDC+, UDC-.



WARNING! Even when power is removed from the input terminals of the ACS550, there may be dangerous voltage (from external sources) on the terminals of the relay outputs RO1...RO3 or on option modules.



WARNING! Dangerous voltage is present when input power is connected. After disconnecting the supply, wait at least 5 minutes (to let the intermediate circuit capacitors discharge) before removing any covers.



WARNING! The ACS550-U2 is field repairable by qualified personnel only. To service or repair a malfunctioning unit, contact your local Authorized Service Center.



WARNING! The ACS550 will start up automatically after an input voltage interruption if the external run command is on.



WARNING! When the control terminals of two or more drive units are connected in parallel, the auxiliary voltage for these control connections must be taken from a single source, which can either be one of the units, or an external supply.



WARNING! The heat sink may reach a high temperature. See Technical Data chapter in User's Manual.

Table of contents

Safety

Use of warnings and notes	3
---------------------------------	---

Table of contents

Installation

Introduction	7
Planning	7
Moving the unit	7
Mounting	8
Connecting power and control cables	8

Maintenance

Safety	11
Separating the drive and extension modules	11

Technical data

Ratings	13
Fuses	15
Cable entries	16
Input power (mains) connection	16
Power factor compensation capacitors	17
Motor connection	18
Control connections	19
Efficiency	19
Cooling and required free space	19
Dimensions, weights and noise	19
Degrees of protection	20
Ambient conditions	20
Dimension drawings	21

Installation

Introduction

ACS550-U2 drives include an extension module that is not covered in the ACS550-02/U2 User's Manual. The extension module is attached to the drive module at the factory.

This supplement provides the additional extension module information required for ACS550-U2 drives:

- Additional installation steps and considerations.
- Steps for separating the drive from the extension module for drive service access.
- Dimensions for the extension module.

This supplement requires and routinely refers to the document: ACS550-02/U2 User's Manual.

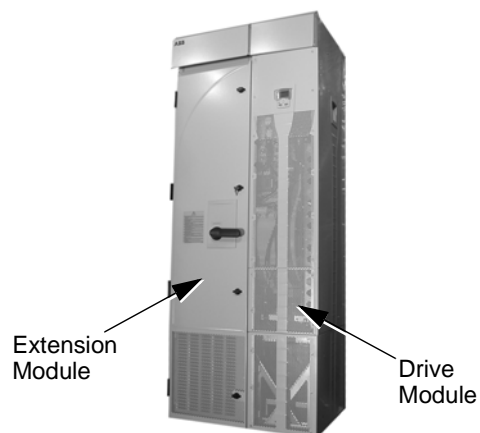

WARNING! Only qualified electricians are allowed to carry out the work described in this chapter. Follow requirements in [Safety](#) on the first pages of this manual. Ignoring the safety instructions can cause injury or death.

Planning

When planning for cable/conduit routing, refer to the ACS550-02/U2 User's Manual, but note that, for the ACS550-U2, all connections are routed through the top of the extension module.

Moving the unit

1. Move the transport package by pallet truck to the installation site.
2. Unpack the transport package.
3. To position the unit, use a lift, connected as shown.

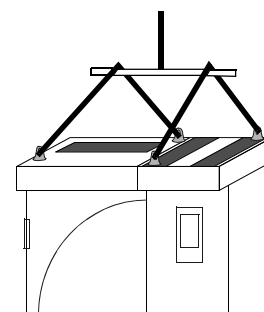

Mounting

Fastening the Unit

See the [Dimension drawings](#) in the [Technical data](#) section of this document for the exact locations of the mounting points.

4. Use at least four screws – two at the front, two at the back – to attach the unit base plate to the floor.
5. Use at least two screws to attach the back of the enclosure to a wall.

There are two holes available at the top of each: the extension module and the drive module.

Connecting power and control cables

Additional considerations that apply with the enclosure extension:

- The power cable connection diagram that applies for the ACS550-U2 is:

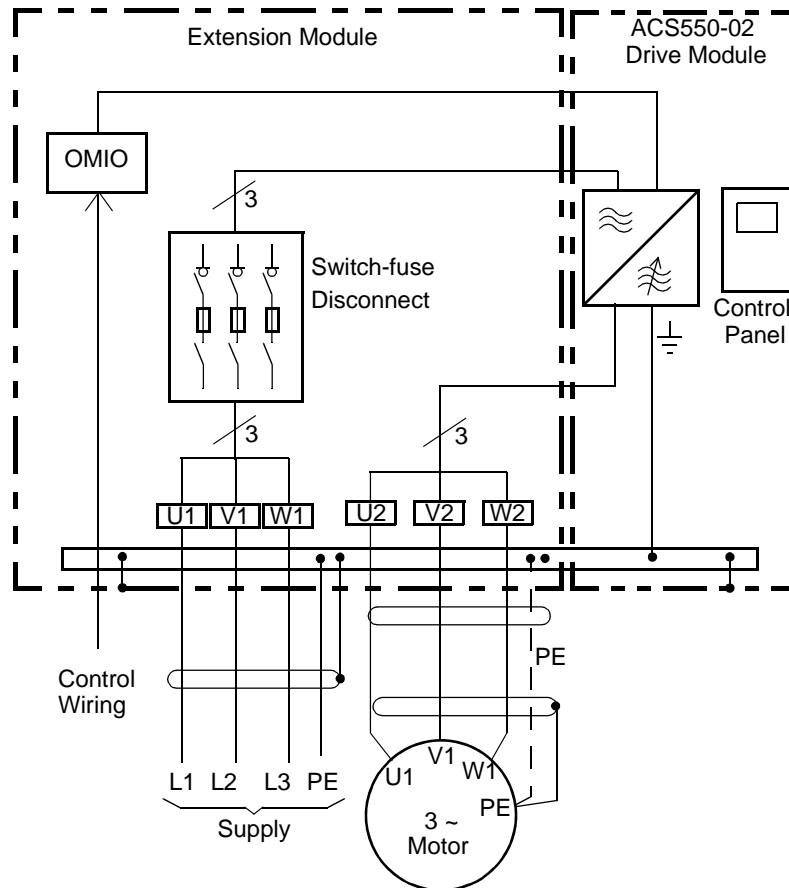

- Temporarily remove the upper high voltage shield (clear plastic) to gain access to the power connections in the extension module.
- To avoid metal shavings inside the cabinet, temporarily remove the gland/conduit plate at the top of the extension module. Then drill holes and mount conduit or cable fittings as needed.

- Route all power and control wiring through the top of the extension module.
- The following diagram shows the power and control connection points in the enclosure module supplied with the R8 drive module.

R8 Frame Size

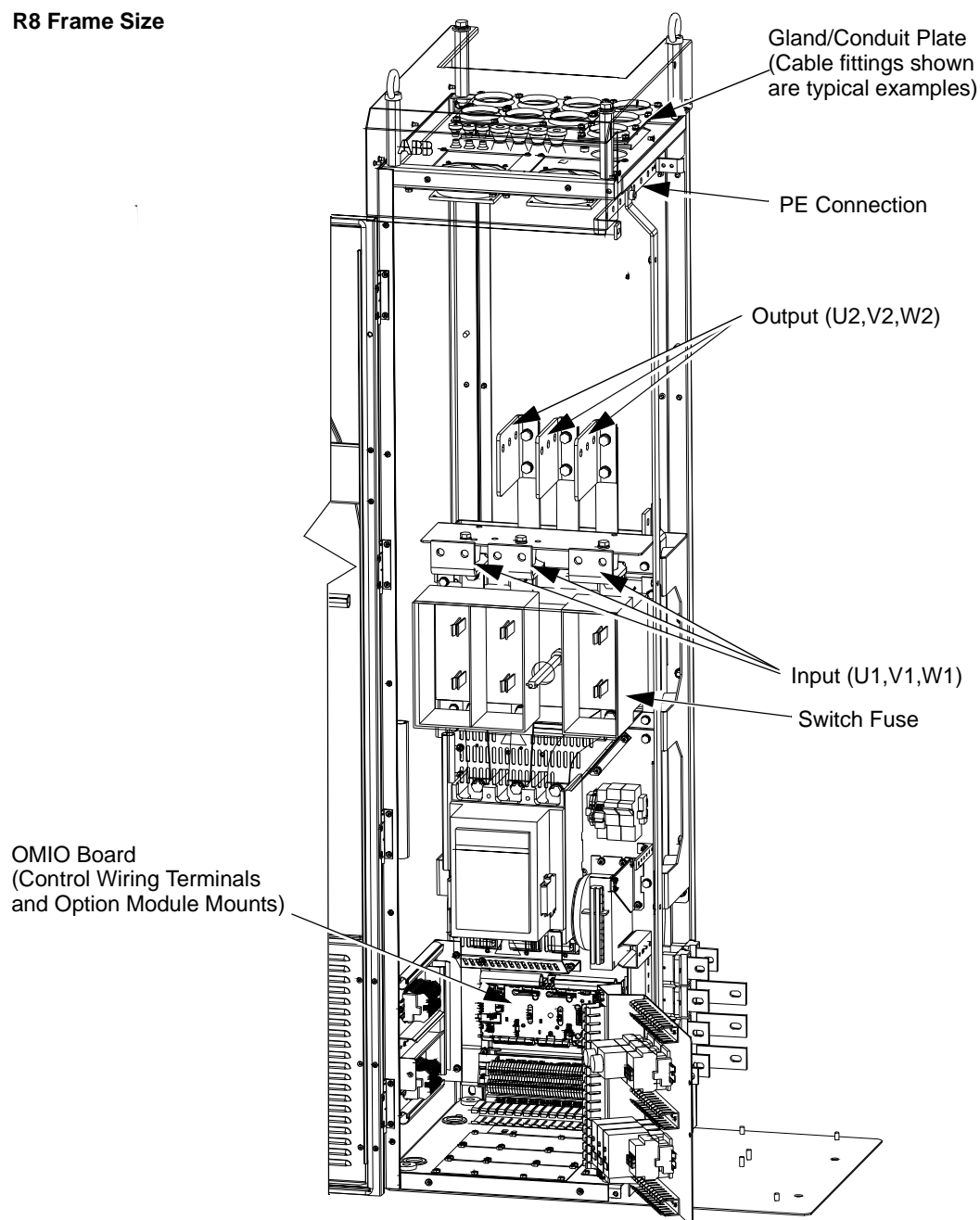

- Re-mount the high voltage shield.



WARNING! Always replace all high voltage shields before applying power.

- See the ACS550-02/U2 User's Manual for detailed instructions on control connections, installation check list and drive start-up process.

Maintenance

This section describes the procedure for separating the drive and extension modules, which is required to provide service access to the drive module.

Safety



WARNING! Read [Safety](#) on the first pages of this manual before performing any maintenance on the equipment. Ignoring the safety instructions can cause injury or death. **Note:** There are parts carrying dangerous voltages near the OMIO board when the drive is powered.

Separating the drive and extension modules

The drive module is mounted on a trolley that straddles a pedestal. The following procedure removes mechanical connections so that the drive module and trolley can roll forward for service access.

1. Disconnect all power sources from the drive/extension modules and wait at least 5 minutes for internal capacitors to fully discharge.
2. Remove all front covers from the drive module.
3. Disconnect the control panel cable.
4. Remove the upper side plate from the drive module if convenient.
5. Remove screws (if any) that fasten the drive module to the wall.
6. Inside the pedestal, toward the rear are screws that attach the drive bus bars to the pedestal bus bars. The connections are staggered for easy access using a wrench with an extension. Remove these screws (6).

Torque when re-assembling:

- R8: M10 (3/8 in) screws, 30...44 Nm (22...32 lb ft)



WARNING! Be careful not to drop screws inside the pedestal. Loose metal pieces inside the unit may cause damage.



7. The following cables between the drive and the extension module are split by a connector located at the front of the drive. Disconnect both cables at this location.
 - The power supply cable to the OMIO board.
 - The power supply cable to the extension module cooling fan.
8. At the OTIF board, disconnect the two fiber optic cables. Make note of the terminal colors for use when reconnecting.
9. Carefully remove the cables disconnected in the above steps: Pull the cables down inside the pedestal and bundle them so that they will not get damaged or caught in the trolley when the drive module is wheeled out.

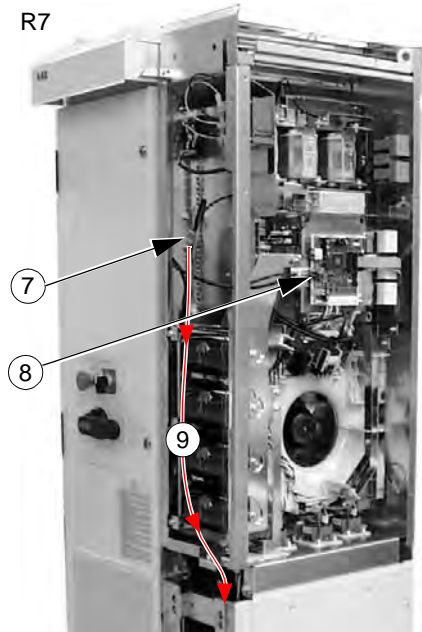

10. Remove screws fastening the drive module trolley to the pedestal.



WARNING! These screws are an important step during re-assembly – the screws are required for grounding the drive.

11. **R8:** The front of the trolley includes support braces that fold out. Lift each brace slightly and fold it out.
12. Remove screws that fasten the drive module to the extension module.



CAUTION! The drive module is now separated and could tip over. Use care when moving the drive module.

13. Pull on the handle to wheel the drive module out.

Drive maintenance

See the ACS550-02/U2 User's Manual for drive maintenance procedures.

Re-assembly

Re-attach the modules in reverse order to the above.

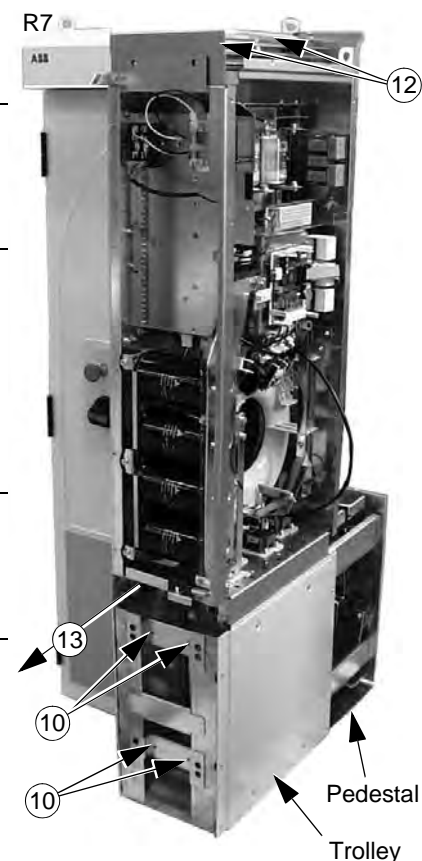

Technical data

Ratings

By type code, the table below provides ratings for the ACS550 adjustable speed AC drive, including:

- ratings
- frame size
- drive cabinet heat dissipation and air flow.

Ratings, 480 volt drives

Type code ACS550-U2 UL Type 1 (NEMA 1)	Ratings (380...480 V AC supply)						Frame size
	Normal use		Heavy-duty use		Heat dissipation	Air flow	
	I_{2N} A	P_N hp	I_{2hd} A	P_{hd} hp	BTU/hr	ft ³ /min	
-316A-4	316	250	240	200	23394	718	R8
-368A-4	368	300	302	250	23394	718	R8
-414A-4	414	350	368	300	26809	718	R8
-486A-4	486	400	414	350	26809	718	R8
-526A-4	526	450	477	400	25955	718	R8
-602A-4	602	500	515	450	27663	718	R8
-645A-4	645	550	590	500	31078	718	R8

Symbols

Typical ratings:

Normal use (10% overload capability)

I_{2N} continuous rms current. 10% overload is allowed for one minute in ten minutes.

P_N typical motor power. The power ratings apply to most IEC 34, or NEMA 4-pole motors at the nominal voltage, 400 V or 460 V.

Heavy-duty use (50% overload capability)

I_{2hd} continuous rms current. 50% overload is allowed for one minute in ten minutes.

P_{hd} typical motor power. The power ratings apply to most IEC 34, or NEMA 4-pole motors at the nominal voltage, 400 V or 460 V.

Sizing

The current ratings are the same regardless of the supply voltage within one voltage range. To achieve the rated motor power given in the table, the rated current of the drive must be higher than or equal to the rated motor current.

Note 1: The maximum allowed motor shaft power is limited to $1.5 \cdot P_{hd}$. If the limit is exceeded, motor torque and current are automatically restricted. The function protects the input bridge of the drive against overload.

Note 2: The ratings apply in ambient temperature of 40 °C (104 °F).

Derating

The load capacity (current and power) decreases if the installation site altitude exceeds 1000 meters (3300 ft) or if the ambient temperature exceeds 40 °C (104 °F).

Temperature derating

In the temperature range +40 °C...50 °C (+104 °F...122 °F), the rated output current is decreased 1% for every 1 °C (1.8 °F) above +40 °C (+104 °F). Calculate the output current by multiplying the current given in the rating table by the derating factor.

Example If the ambient temperature is 50 °C (+122 °F), the derating factor is $100\% - 1\%/^{\circ}\text{C} \cdot 10\text{ }^{\circ}\text{C} = 90\%$ or 0.90.

The output current is then $0.90 \cdot I_{2N}$ or $0.90 \cdot I_{2hd}$.

Altitude derating

In altitudes from 1000...4000 m (3300...13,200 ft) above sea level, the derating is 1% for every 100 m (330 ft). If the installation site is higher than 2000 m (6600 ft) above sea level, please contact your local ABB distributor or office for further information.

Fuses

Fuses

Note: Fuses from other manufacturers may be used if they meet the functional characteristics of those in this table.

Type code ACS550-U2	Input current	Fuses	
		UL Class T	Bussmann type
-316A-A	316	400	JJS-500
-368A-4	368	400	JJS-500
-414A-A	414	600	JJS-500
-486A-4	486	600	JJS-600
-526A-4	526	800	JJS-800
-602A-4	602	800	JJS-800
-645A-4	645	800	JJS-800

Cable types

Cable sizing is based on NEC Table 310.16 for copper wires, 75 °C (167 °F) wire insulation at 40 °C (104 °F) ambient temperature. Not more than three current-carrying conductors in raceway or cable or earth (directly buried). For other conditions, dimension the cables according to local safety regulations, appropriate input voltage and the load current of the drive.

In any case, the cable must be between the minimum limit defined in this table and the maximum limit defined by the terminal size (see [Cable entries](#) on page 16).

Insulated copper conductors	
Max. load current A	Conductor size AWG/kcmil
334	500 MCM or 2 × 3/0
370	600 MCM or 2 × 4/0 or 3 × 1/0
405	700 MCM or 2 × 4/0 or 3 × 2/0
449	2 × 250 MCM or 3 × 2/0
502	2 × 300 MCM or 3 × 3/0
546	2 × 350 MCM or 3 × 4/0
590	2 × 400 MCM or 3 × 4/0
669	2 × 500 MCM or 3 × 250 MCM
739	2 × 600 MCM or 3 × 300 MCM

Cable entries

Mains and motor cable maximum sizes (per phase) accepted at the cable terminals, and the tightening torques are listed below.

Frame size	U1, V1, W1, U2, V2, W2						Earthing PE		
	Number of cable lead-through holes per phase	Max. cable diameter		Bolt size	Tightening torque		Bolt size	Tightening torque	
		mm	in		N-m	lbf-ft		N-m	lbf-ft
R8	3	58	2.28	M12	50...75	35...55	M8	15...22	10...16

Input power (mains) connection

Input power (mains) connection specifications	
Voltage (U_1)	400/415/440/460/480 V AC 3-phase +10% -15% for 400 V AC drives
Short-circuit current protection (UL 508)	US and Canada: According to UL 508, the drive is suitable for use in a circuit capable of delivering not more than 100 kA symmetrical amperes (rms) at 480 V maximum when protected by UL fuses given in the fuse table on page 15 .
Frequency	48...63 Hz
Imbalance	Max. \pm 3% of nominal phase to phase input voltage
Fundamental power factor ($\cos \phi_1$)	0.98 (at nominal load)
Cable temperature rating	70 °C (158 °F) rating minimum

Power factor compensation capacitors

Power factor compensation is not needed with AC drives. However, if a drive is to be connected in a system with compensation capacitors installed, note the following restrictions.



WARNING! Do not connect power factor compensation capacitors or surge absorbers to the motor cables (between the drive and the motor). They are not meant to be used with AC drives and can cause permanent damage to the drive or themselves.

If there are power factor compensation capacitors in parallel with the three phase input of the drive:

1. Do not connect a high-power capacitor to the power line while the drive is connected. The connection will cause voltage transients that may trip or even damage the drive.
2. If capacitor load is increased/decreased step by step when the AC drive is connected to the power line: Ensure that the connection steps are low enough not to cause voltage transients that would trip the drive.
3. Check that the power factor compensation unit is suitable for use in systems with AC drives, i.e. harmonic generating loads. In such systems, the compensation unit should typically be equipped with a blocking reactor or harmonic filter.

Motor connection

Motor connection specifications	
Voltage (U_2)	0... U_1 , 3-phase symmetrical, U_{max} at the field weakening point
Frequency	0...500 Hz
Frequency resolution	0.01 Hz
Current	See section Ratings on page 13.
Power limit	$1.5 \cdot P_{hd}$
Field weakening point	10...500 Hz
Switching frequency	Selectable: 1, 4 kHz
Cable temperature rating	70 °C (158 °F) rating minimum.
Maximum motor cable length	See section Motor cable length below.

Motor cable length

The table below shows the maximum motor cable lengths for 1 or 4 kHz switching frequencies.

Frame size	Operational limits			
	Basic limits		With du/dt filters	
	m	ft	m	ft
R8	300	980	300	980

Under heading “Operational limits”, the “Basic unit” columns define the cable lengths with which the basic drive unit works without problems within the drive specification, without installing any further options. Column “With du/dt filters” defines the cable lengths when an external du/dt filter is used.



WARNING! Using a motor cable longer than specified in the table above may cause permanent damage to the drive.

Control connections

Control connection specifications	
Analog inputs and outputs	See the ACS550-02/U2 User's Manual Hardware description table on page 55.
Digital inputs	Digital input impedance 1.5 k Ω . Maximum voltage for digital inputs is 30 V.
Relays (Digital outputs)	<ul style="list-style-type: none"> Max. contact voltage: 30 V DC, 250 V AC Max. contact current / power: 6 A, 30 V DC; 1500 VA, 250 V AC Max. continuous current: 2 A rms ($\cos \phi = 1$), 1 A rms ($\cos \phi = 0.4$) Minimum load: 500 mW (12 V, 10 mA) Contact material: Silver-nickel (AgN) Isolation between relay digital outputs, test voltage: 2.5 kV rms, 1 minute

Frame size	Control terminals			
	Maximum wire size ¹		Torque	
	mm ²	AWG	N-m	lbf-ft
R8	1.5	16	0.4	0.3

¹ Values given for solid wires.
For stranded wires the maximum size is 1 mm².

Efficiency

Approximately 98% at nominal power level.

Cooling and required free space

Cooling Specifications	Internal fan, flow direction from front to top.
Free space around the drive	The cooling air enters the unit from the front air grating, flows upward inside the unit and out the top. A 12" space above the unit is required for cooling. A 24" space in front of the unit is required for cooling and maintenance. See ACS550-02/U2 User's Manual, Installation Procedures, choose the mounting orientation (a, b or c) on page 25 for additional detail.

Dimensions, weights and noise

The dimensions and mass for the ACS550 depend on the frame size and enclosure type, refer to section [Dimension drawings](#) on page 21.

Frame size	H		W		D		Weight		Noise
	mm	in	mm	in	mm	in	kg	lb	dB
R8	2024	79.69	793	31.24	622	24.47	376	827	72

Degrees of protection

Available enclosures:

- IP21 / UL type 1 enclosure. The site must be free of airborne dust, corrosive gases or liquids, and conductive contaminants such as condensation, carbon dust, and metallic particles.

Ambient conditions

The following table lists the ACS550 environmental requirements.

Ambient environment requirements		
	Installation site	Storage and transportation in the protective package
Altitude	<ul style="list-style-type: none"> • 0...1000 m (0...3 300 ft) • 1000...2000 m (3 300...6 600 ft) if P_N and I_{2N} derated 1% every 100 m above 1000 m (300 ft above 3 300 ft) 	
Ambient temperature	<ul style="list-style-type: none"> • -15...40 °C (5...104 °F), no frost allowed • Max. 50 °C (122 °F) if P_N and I_{2N} derated to 90% 	-40...70 °C (-40...158 °F)
Relative humidity	< 95% (non-condensing)	
Contamination levels	<ul style="list-style-type: none"> • No conductive dust allowed. • The drive should be installed in clean air according to enclosure classification. • Cooling air must be clean, free from corrosive materials and free from electrically conductive dust. • Chemical gases: Class 3C2 • Solid particles: Class 3S2 	Storage <ul style="list-style-type: none"> • No conductive dust allowed. • chemical gases: Class 1C2 • solid particles: Class 1S2 Transportation <ul style="list-style-type: none"> • No conductive dust allowed. • Chemical gases: Class 2C2 • Solid particles: Class 2S2
Sinusoidal vibration	<ul style="list-style-type: none"> • Mechanical conditions: Class 3M4 (IEC 60721-3-3) • 2...9 Hz 3.0 mm (0.12 in) • 9...200 Hz 10 m/s² (33 ft/s²) 	Storage <ul style="list-style-type: none"> • Max. 1 mm (0.04 in) (5 to 13.2 Hz), max. 7 m/s² (23 ft/s²) (13.2 to 100 Hz) sinusoidal Transportation <ul style="list-style-type: none"> • Max. 3.5 mm (0.14 in.) (2 to 9 Hz), max. 15 m/s² (49 ft/s²) (9 to 200 Hz) sinusoidal
Shock	Not allowed	max. 100 m/s ² (330 ft/s ²), 11 ms
Free fall	Not allowed	100 mm (4 in) for weight over 100 kg (220 lb)

Dimension drawings

The dimensions are given in millimeters [inches].

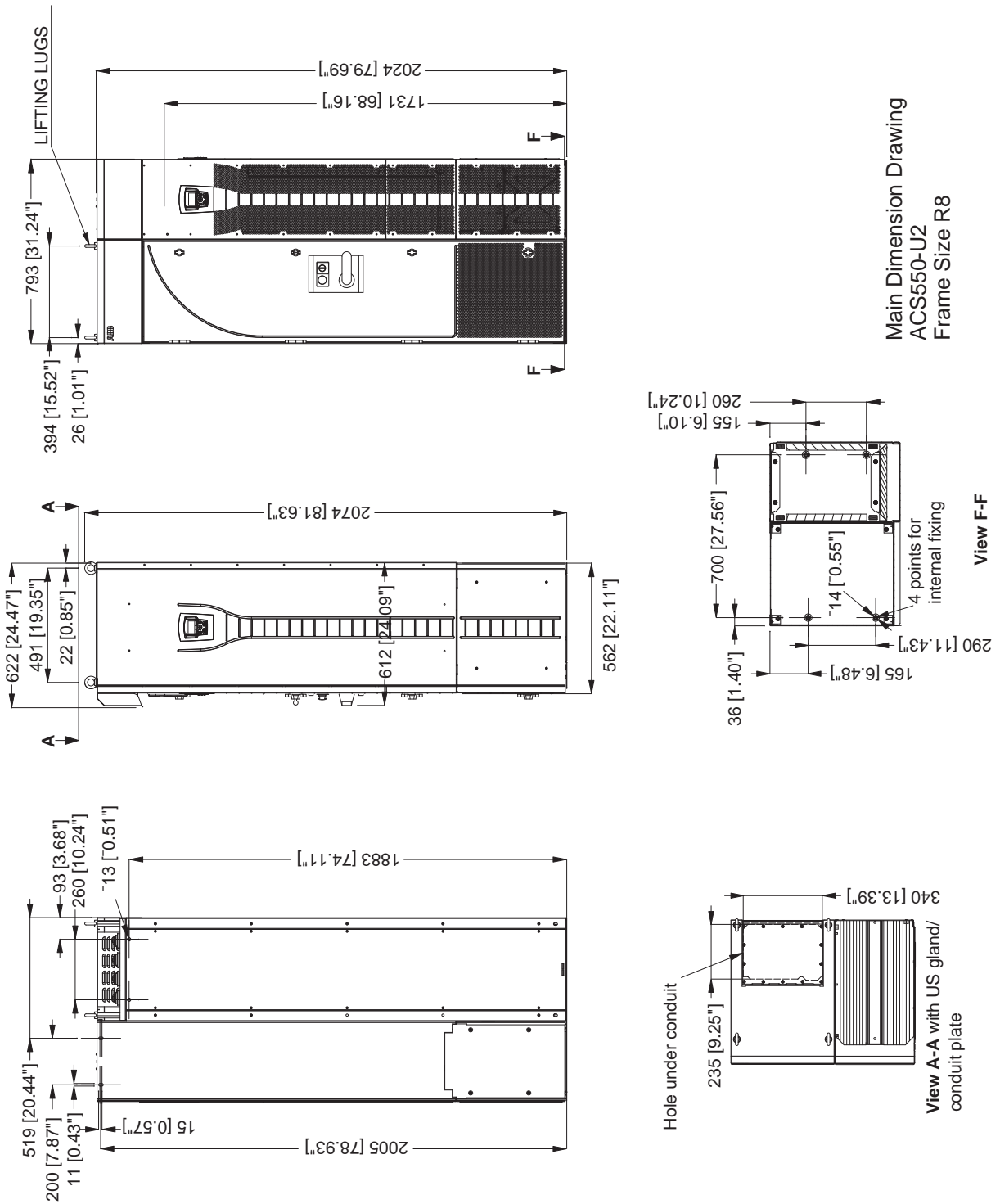

Main Dimension Drawing
ACS550-U2
Frame Size R8

Detail

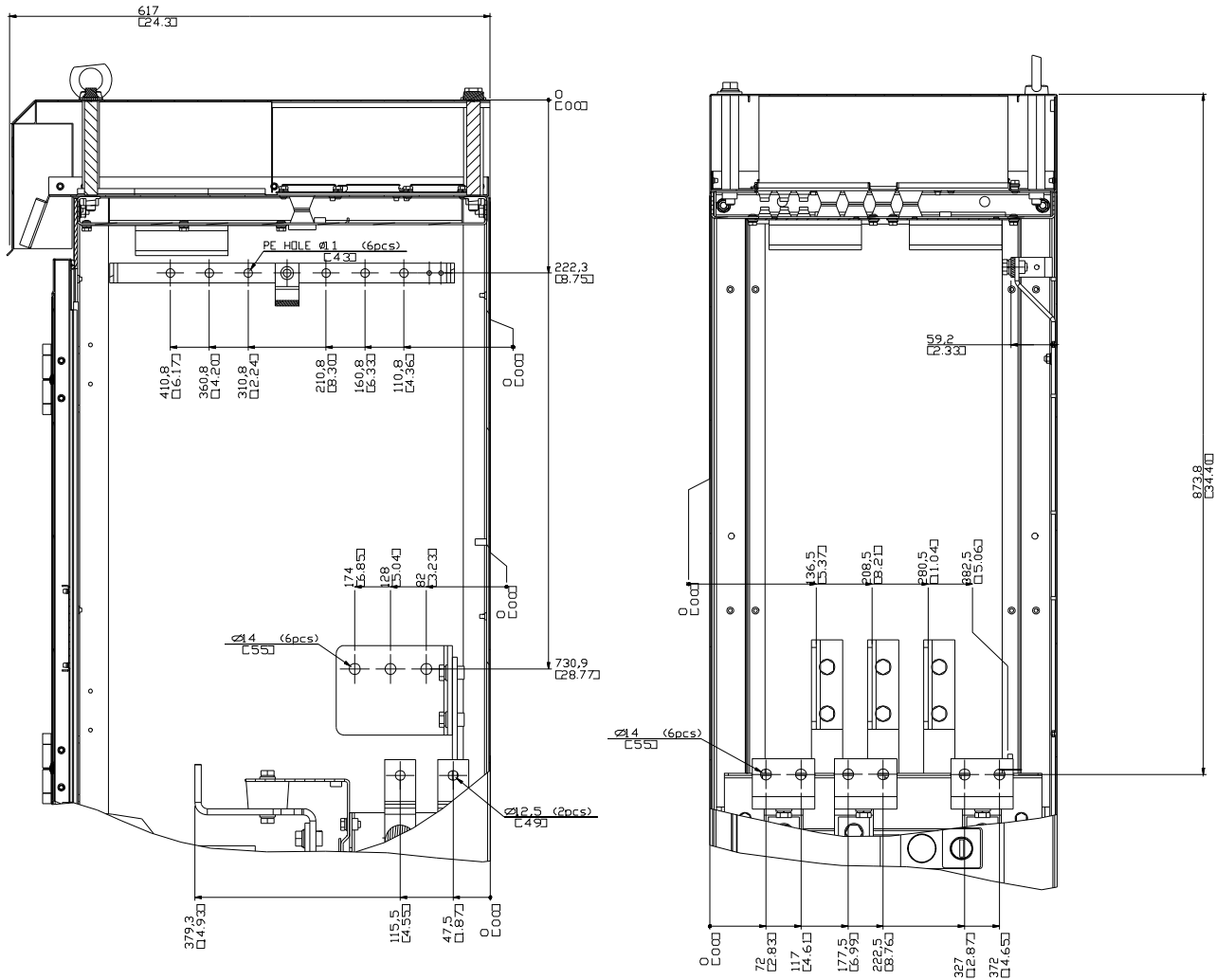

Dimensions are listed in millimeters [inches]