

ABB Drives

User's Manual PROFIBUS DP Adapter Module FPBA-01



PROFIBUS DP Adapter Module FPBA-01

User's Manual

3AFE68573271 REV D
EN
EFFECTIVE: 22.01.2010

© 2010 ABB Oy. All Rights Reserved.

Safety instructions

Overview

This chapter states the general safety instructions that must be followed when installing and operating the FPBA-01 PROFIBUS DP® Adapter module.

The material in this chapter must be studied before attempting any work on, or with, the unit.

In addition to the safety instructions given below, read the complete safety instructions of the specific drive you are working on.

General safety instructions



WARNING! All electrical installation and maintenance work on the drive should be carried out by qualified electricians. The drive and adjoining equipment must be properly earthed.

Do not attempt any work on a powered drive. After switching off the mains, always allow the intermediate circuit capacitors 5 minutes to discharge before working on the frequency converter, the motor or the motor cable. It is good practice to check (with a voltage indicating instrument) that the drive is in fact discharged before beginning work.

The motor cable terminals of the drive are at a dangerously high voltage when mains power is applied, regardless of motor operation.

There can be dangerous voltages inside the drive from external control circuits even when the drive mains power is shut off. Exercise appropriate care when working on the unit. Neglecting these instructions can cause physical injury or death.

Table of contents

Safety instructions	5
Overview	5
General safety instructions	5
 Table of contents	 7
 Introduction	 11
Intended audience	11
Before you start	11
What this manual contains	11
Terms used in this manual	13
Further information	13
Product and service inquiries	13
Product training	13
Providing feedback on ABB Drives manuals	14
 Overview	 15
Overview	15
PROFIBUS standard	15
The FPBA-01 PROFIBUS DP Adapter module	16
Compatibility	17
Delivery check	18
 Quick start-up guide	 19
Overview	19
PLC configuration	19
Mechanical and electrical installation	22
Drive configuration	22
Cyclic data handling	22

Parameter setting examples – ACS350 and ACS355	23
Parameter setting examples – ACSM1	26
Parameter setting examples – ACS850 and ACQ810	33
<i>Mechanical installation</i>	35
Mounting	35
<i>Electrical installation</i>	37
Overview	37
General cabling instructions	37
PROFIBUS connection	38
Bus termination	40
<i>Drive configuration</i>	41
Overview	41
PROFIBUS connection configuration	41
Control locations	49
<i>Master configuration</i>	51
Overview	51
Configuring the system	51
<i>Communication profiles</i>	53
Overview	53
Communication profiles	53
The PROFIdrive communication profile	55
The Control Word and the Status Word	55
References	55
Actual values	56
The ABB Drives communication profile	63
The Control Word and the Status Word	63
References	63
Actual values	65

Communication	71
Overview	71
PROFIBUS DP	71
Service Access Points (SAPs)	71
Communication start-up	72
Other SAPs for DP-V1 communication	86
Cyclical message types	87
PPO types	87
Standard telegram (ST) types	88
Parameter handling in cyclic communication (DP)	89
Parameter data transfer examples	93
DP-V1 read/write request sequence	100
Parameter data transfer examples	110
Diagnostics	121
LED indications	121
PROFIdrive parameters	123
PROFIdrive profile-specific parameters	123
I&M (Identification & Maintenance) records	128
Call-REQ-PDU telegram for read/write access to I&M records:	128
Response structure for I&M0 (Read-only)	128
Response structure for I&M1 (Read/Write)	129
Response structure for I&M2 (Read/Write)	129
Definitions and abbreviations	131
PROFIBUS definitions	131
PROFIBUS abbreviations	133
Technical data	135
FPBA-01	135
PROFIBUS link	137

Introduction

Intended audience

The manual is intended for the people who are responsible for commissioning and using an FPBA-01 PROFIBUS DP Adapter module. The reader is expected to have a basic knowledge of electrical fundamentals, electrical wiring practices and how to operate the drive.

Before you start

It is assumed that the drive is installed and ready to operate before starting the installation of the extension module.

In addition to conventional installation tools, have the drive manuals available during the installation as they contain important information not included in this manual. The drive manuals are referred to at various points of this document.

What this manual contains

This manual contains information on the wiring, configuration and use of the FPBA-01 PROFIBUS DP Adapter module.

Safety instructions are featured in the first few pages of this manual.

Overview contains a short description of the PROFIBUS protocol and the FPBA-01 PROFIBUS DP Adapter module, and a delivery checklist.

Quick start-up guide contains a short description of how to set up the FPBA-01 PROFIBUS DP Adapter module.

Mechanical installation contains placing and mounting instructions for the module.

Electrical installation contains wiring, bus termination and earthing instructions.

Drive configuration explains how to program the drive before the communication through the adapter module can be started.

Master configuration explains how to program the PROFIBUS master before the communication through the adapter module can be started.

Communication profiles describes the communication profiles used in the communication between the PROFIBUS network, the FPBA-01 module, and the drive.

Communication contains a description of how data is transmitted through the FPBA-01 module.

Diagnostics explains how to trace faults with the status LEDs on the FPBA-01 module.

PROFdrive parameters presents the PROFIBUS Profile-specific parameters.

Definitions and abbreviations explains definitions and abbreviations concerning the PROFIBUS protocol family.

Technical data contains information on physical dimensions, configurable settings and connectors of the module and the specification of the PROFIBUS link.

Terms used in this manual

Communication Module

Communication Module is a name for a device (e.g. a fieldbus adapter) through which the drive is connected to an external communication network (e.g. a fieldbus). The communication with the module is activated with a drive parameter.

FPBA-01 PROFIBUS DP Adapter module

The FPBA-01 PROFIBUS DP Adapter module is one of the optional fieldbus adapter modules available for ABB drives. The FPBA-01 is a device through which an ABB drive is connected to a PROFIBUS network.

Parameter

A parameter is an operating instruction for the drive. Parameters can be read and programmed with the drive control panel, or through the FPBA-01 module.

Further information

Further information is available on the World Wide Web from **www.profibus.com**.

Product and service inquiries

Address any inquiries about the product to your local ABB representative, quoting the type code and serial number of the unit in question. A listing of ABB sales, support and service contacts can be found by navigating to ABB website and selecting *Sales, Support and Service network*.

Product training

For information on ABB product training, navigate to ABB website and select *Training courses*.

Providing feedback on ABB Drives manuals

Your comments on our manuals are welcome. Go to ABB website and select *Document Library – Manuals* ~~Feedback form (LV AC drives)~~.

Overview

Overview

This chapter contains a short description of the PROFIBUS standard and the FPBA-01 Adapter module, and a delivery checklist.

PROFIBUS standard

PROFIBUS is an open serial communication standard that enables data exchange between all kinds of automation components. There are three main variations of PROFIBUS: PROFIBUS FMS (Fieldbus Message Specification), PROFIBUS DP (Decentralised Periphery) and PROFIBUS PA (Process Automation).

The physical transmission medium of the bus is a twisted pair cable (according to the RS-485 standard). The maximum length of the bus cable is 100 to 1200 metres, depending on the selected transmission rate (see the chapter *Technical data*). Up to 31 nodes can be connected to the same PROFIBUS network segment without the use of repeaters. With repeaters, it is possible to connect 127 nodes (including repeaters and master station) to the network.

In PROFIBUS communication, the master station – usually a programmable logic controller (PLC) – polls the nodes which respond and take the actions requested by the master. It is also possible to send a command to several nodes at the same broadcast; in this case the nodes do not send a response message to the master.

The PROFIBUS protocol family is specified in the IEC 61158 standard. The communication with a drive is defined in *PROFIdrive-PROFILE – The PROFIBUS Profile for Adjustable Speed Drives*. For further information on PROFIBUS, refer to the above-mentioned standards.

The FPBA-01 PROFIBUS DP Adapter module

The FPBA-01 PROFIBUS DP Adapter module is an optional device for ABB drives which enables the connection of the drive to a PROFIBUS network. The drive is considered as a slave on the PROFIBUS network. Through the FPBA-01 PROFIBUS DP Adapter module, it is possible to:

- give control commands to the drive (Start, Stop, Run enable, etc.)
- feed a motor speed or torque reference to the drive
- give a process actual value or a process reference to the PID controller of the drive
- read status information and actual values from the drive
- change drive parameter values
- reset a drive fault.

The PROFIBUS commands and services supported by the FPBA-01 PROFIBUS DP Adapter module are discussed in the chapter *Communication*. Please refer to the user documentation of the drive as to which commands are supported by the drive.

The adapter module is mounted into an option slot on the motor control board of the drive. See the drive documentation for module placement options.

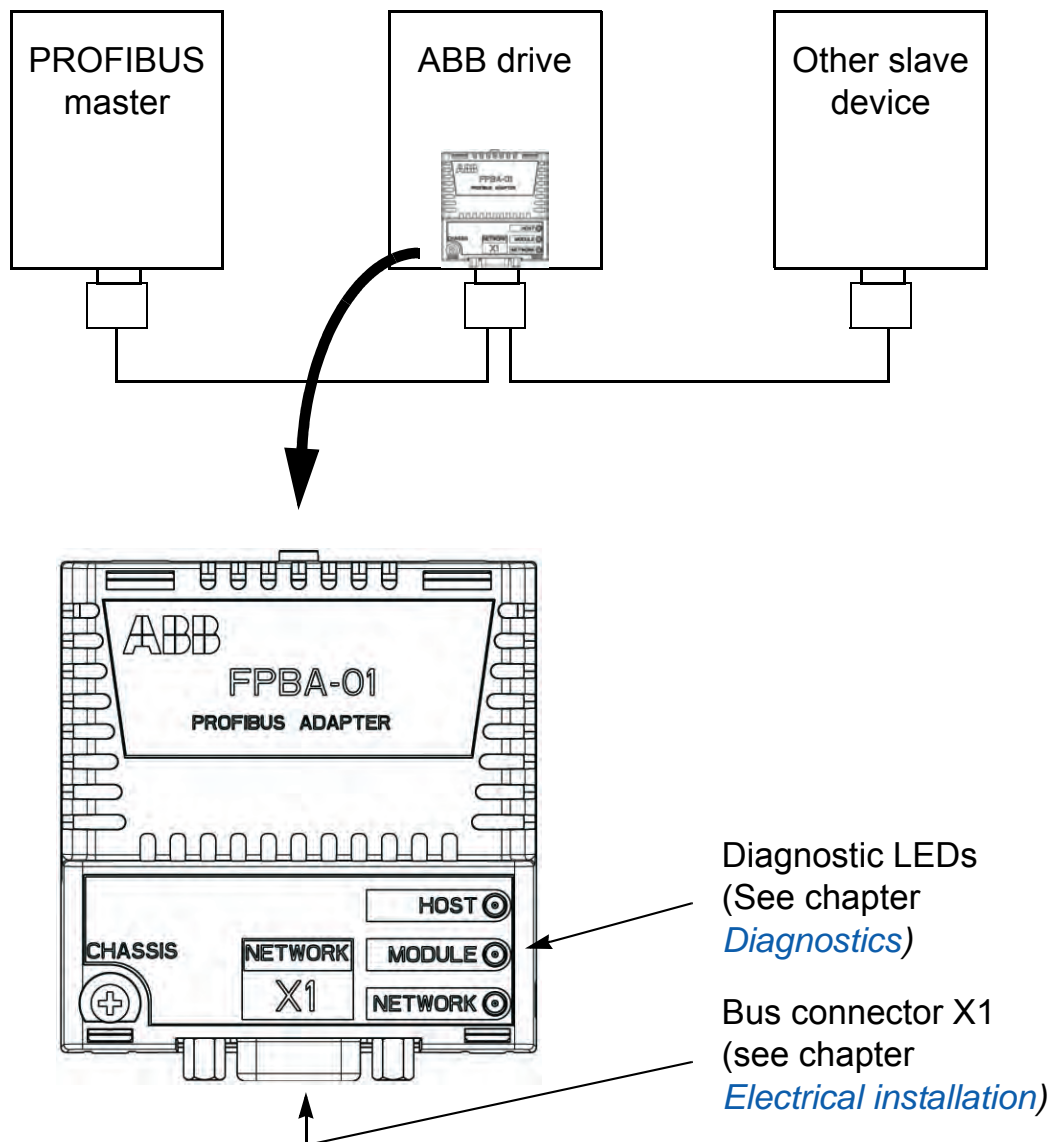

Figure 1. The construction of the PROFIBUS link and the FPBA-01 Adapter module.

Compatibility

The FPBA-01 is compatible with all master stations that support the PROFIBUS DP protocol.

Note: The PROFIBUS DP-V1 protocol is supported from FPBA-01 SW version 2.00A onwards.

Delivery check

The option package for the FPBA-01 PROFIBUS DP Adapter module contains:

- PROFIBUS DP Adapter module, type FPBA-01
- this manual.

Quick start-up guide

Overview

This chapter presents the steps to take during the start-up of the FPBA-01 PROFIBUS DP Adapter Module with an ACS350, ACS355, ACSM1, ACS850 or ACQ810 drive. For more detailed information, see the chapters *Mechanical installation*, *Electrical installation*, and *Drive configuration* elsewhere in this manual.



WARNING! Follow the safety instructions given in this manual and the *Hardware Manual* of the drive.

PLC configuration

- Install the FPBA-01 GSD file (e.g. ABB0959.GSD).

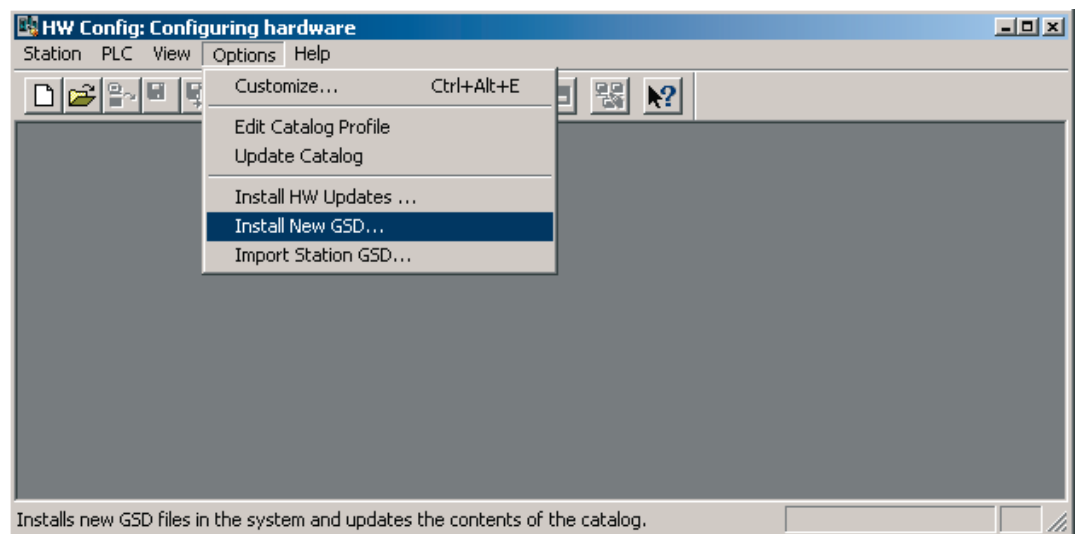

- Select the Fail Safe mode and enter a Failsafe Timeout value.

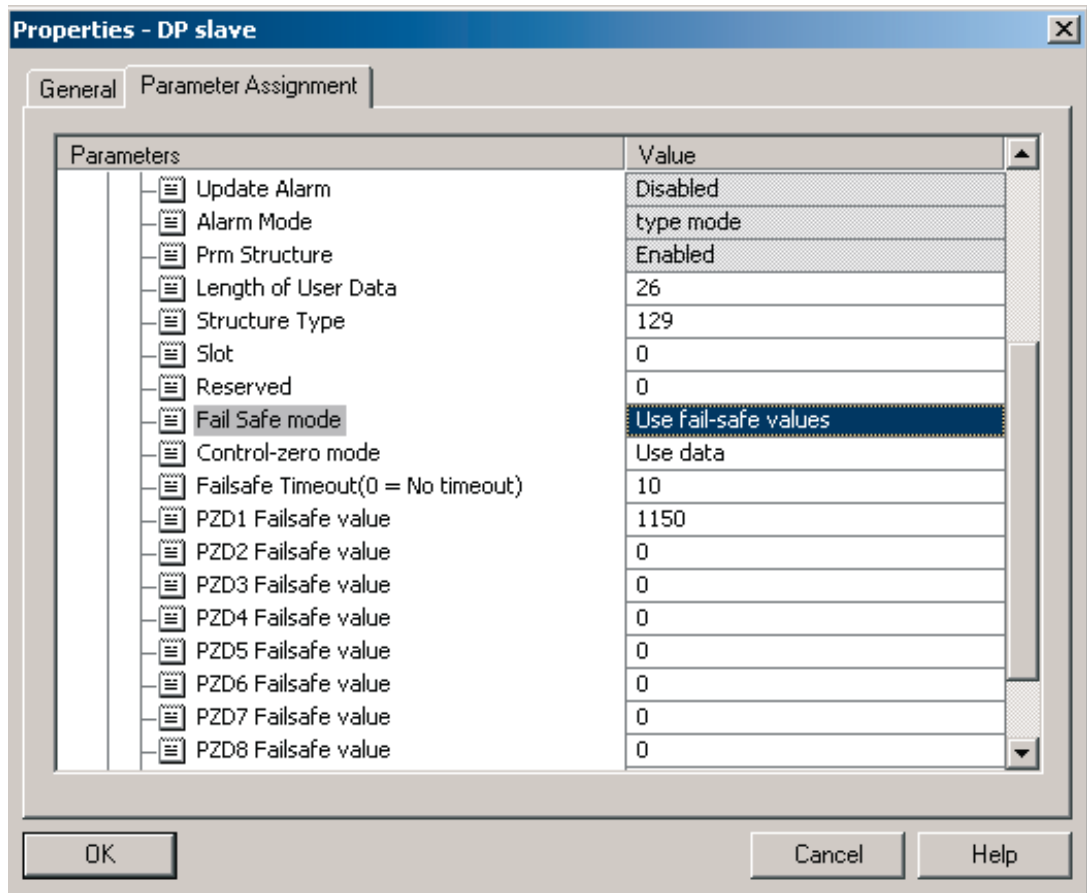

- Set the message type, baud rate and node number.

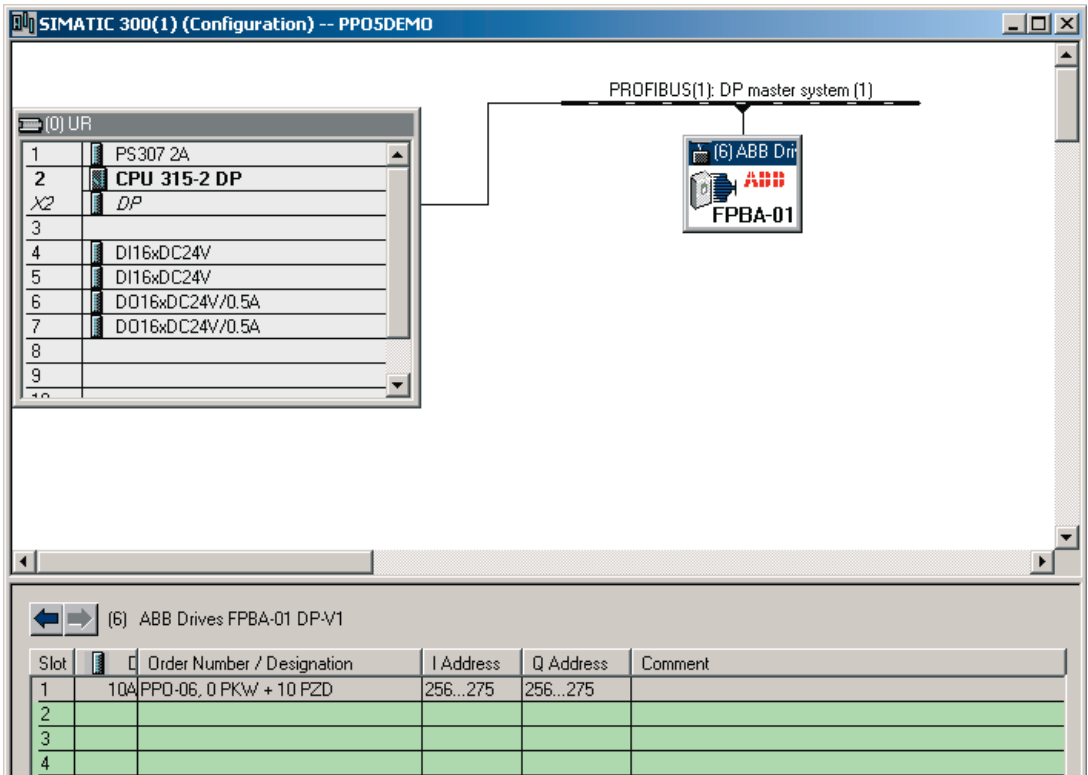
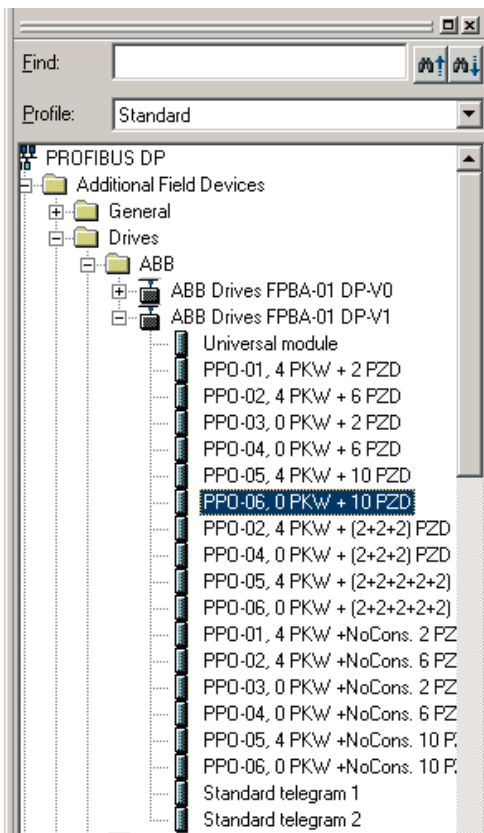

Mechanical and electrical installation

- Insert the FPBA-01 into its specified slot in the drive.
- Fasten the screw.
- Plug the fieldbus connector to the module.

Drive configuration

- Power up the drive.
- The detailed procedure of activating the drive for communication with the module is dependent on the drive type. Normally, a parameter must be adjusted to activate the communication. Refer to the drive documentation for information on the communication settings. With an ACS350 or ACS355 drive, set parameter 9802 COMM PROT SEL to EXT FBA; with an ACSM1 drive, set parameter 50.01 FBA ENABLE to ENABLE; and with an ACS850 or ACQ810 drive, set parameter 50.01 FBA enable to Enable.
- Parameter group 51 shows the status of the FPBA configuration parameters.
- At minimum, set the required node address at parameter 5102 NODE ADDRESS and the communication profile at 5105 PROFILE. Finally, validate the settings with 5127 FBA PAR REFRESH.

Cyclic data handling

With the FPBA-01, both data-consistent and non-consistent communication can be used, data-consistent meaning that the whole cyclic data frame is transmitted during a single program cycle. Some PLCs handle this internally, but others must be programmed to transmit data-consistent telegrams (for more information, see the chapter [Communication](#)). For example, Siemens Simatic S7 requires the use of special functions SFC15 and SFC14.

Network 3: Title:

Comment:

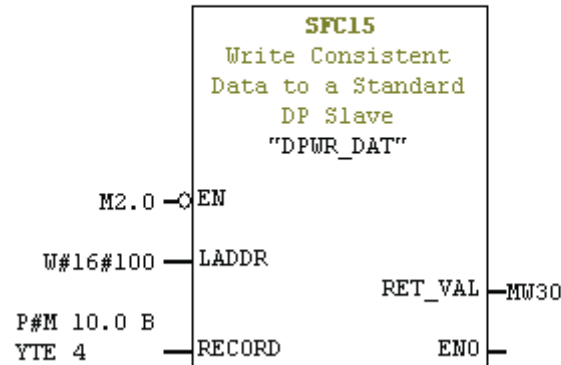

Network 3: Title:

Comment:

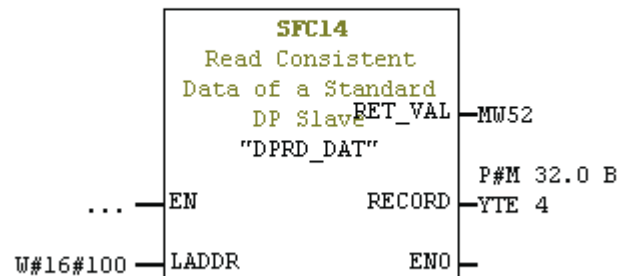

Parameter setting examples – ACS350 and ACS355

PROFdrive communication profile with PPO Type 1

The start/stop commands and reference are according to the PROFdrive profile. (See the PROFIBUS state machine on page 61.) The reference value ± 16384 (4000h) corresponds to parameter 1105 REF1 MAX in forward and reverse directions.

Direction	PZD1	PZD2
Out	Control Word	Speed Reference
In	Status Word	Speed Actual value

The table below gives the recommended drive parameter settings.

Drive parameter	Setting
1001 EXT1 COMMANDS	COMM
1103 REF1 SELECT	COMM
1601 RUN ENABLE	COMM
1604 FAULT RESET SEL	COMM
9802 COMM PROT SEL	EXT FBA
5101 FBA TYPE	PROFIBUS DP*
5102 NODE ADDRESS	3
5103 BAUDRATE	12000*
5104 TELEGRAM TYPE	1 (= PPO 1)*
5105 PROFILE	0 (= PROFIdrive)
•••	
5127 FBA PAR REFRESH	REFRESH
*Read-only or automatically detected/set	

ABB DRIVES communication profile with PPO Type 4

From the PLC programming point, the ABB DRIVES profile is similar to the PROFIdrive profile as shown in the first example.

The start/stop commands and reference are according to the ABB DRIVES profile. (For more information, see the chapter [The ABB Drives communication profile](#) starting on page 63.)

When Reference 1 (REF1) is used, a reference value of ± 20000 (decimal) corresponds to the reference set by parameter 1105 REF1 MAX in the forward and reverse directions.

When Reference 2 (REF2) is used, a reference value of ± 10000 (decimal) corresponds to the reference set by parameter 1108 REF2 MAX in the forward and reverse directions.

The minimum and maximum 16-bit integer values that can be given through the fieldbus are -32768 and 32767 respectively.

Direction	PZD1	PZD2	PZD3	PZD4	PZD5	PZD6
Out	Control Word	Speed Reference	Critical speed set*	Critical speed 1 lo*	Critical speed 1 hi*	N/A
In	Status Word	Speed Actual value	Power*	DC bus voltage*	N/A	N/A
*Example						

The table below gives the recommended drive parameter settings.

Drive parameter	Setting
1001 EXT1 COMMANDS	COMM
1103 REF1 SELECT	COMM
1601 RUN ENABLE	COMM
1604 FAULT RESET SEL	COMM
9802 COMM PROT SEL	EXT FBA
5101 FBA TYPE	PROFIBUS DP*
5102 NODE ADDRESS	4
5103 BAUDRATE	1500*
5104 TELEGRAM TYPE	4 (= PPO 4)*
5105 PROFILE	1 (= ABB DRIVES)
5401 DATA IN 1	4 (Status Word)*
5402 DATA IN 2	5 (Actual value 1)*
5403 DATA IN 3	106 (POWER)**
5404 DATA IN 4	107 (DC BUS VOLTAGE)**
• • •	
5501 DATA OUT 1	1 (Control Word)*

5502 DATA OUT 2	2 (REF1)*
5503 DATA OUT 3	2501 (CRIT SPEED SEL)**
5504 DATA OUT 4	2502 (CRIT SPEED 1 LO)**
5505 DATA OUT 5	2503 (CRIT SPEED 1 HI)**

5127 FBA PAR REFRESH	REFRESH
----------------------	---------

*Read-only or automatically detected/set
**Example

Parameter setting examples – ACSM1

*PROFIdrive communication profile (Speed Control Mode)
with PPO Type 1*

The start/stop commands and reference are according to the PROFIdrive profile *Speed Control Mode*. (See the PROFIBUS state machine on page 61.) The reference value ± 16384 (4000h) corresponds to parameter 25.02 SPEED SCALING in forward and reverse directions.

Direction	PZD1	PZD2
Out	Control Word	Speed Reference
In	Status Word	Speed Actual value

The table below gives the recommended drive parameter settings.

Drive parameter	Setting
50.01 FBA ENABLE	ENABLE
50.04 FBA REF1 MODESEL	SPEED
10.01 EXT1 START FUNC	FBA
24.01 SPEED REF1 SEL	FBA REF1
34.03 EXT1 CTRL MODE 1	SPEED
51.01 FBA TYPE	PROFIBUS DP*
51.02 NODE ADDRESS	3

51.03 BAUDRATE	12000*
51.04 TELEGRAM TYPE	1 (= PPO 1)*
51.05 PROFILE	0 (= PROFIdrive)
52.02 FBA DATA IN1	4*
52.02 FBA DATA IN2	5
53.01 FBA DATA OUT1	1*
53.02 FBA DATA OUT2	2

51.27 FBA PAR REFRESH	REFRESH
-----------------------	---------

*Read-only or automatically detected/set

*PROFIdrive communication profile (Positioning Mode)
with PPO Type 4*

The start/stop commands and reference are according to the PROFIdrive profile *Positioning Mode*. The Position setpoint and velocity reference are defined as 32-bit integer values; both are scaled as defined by drive parameter settings.

Direction	PZD1	PZD2	PZD3	PZD4	PZD5	PZD
Out	Control Word (STW1)	Position setpoint		Velocity reference		N/A
In	Status Word (ZSW1)	Position actual value		Velocity actual value		N/A

The table below gives the recommended drive parameter settings.

Drive parameter	Name	Value	Description
50.01	FBA ENABLE	ENABLE	Communication enable between the drive and the fieldbus module
50.04	FBA REF1 MODESEL	POSITION	Fieldbus reference 1 mode selection
50.05	FBA REF2 MODESEL	VELOCITY	Fieldbus reference 2 mode selection

10.01	EXT1 START FUNC	FBA	External 1 control source selection
22.01	SPEED FB SEL	ENC1 SPEED**	Speed feedback selection
34.02	EXT1 MODE 1/ 2SEL	P.FBA MAIN CW.26	External 1 control mode selection. Selection is done by START_HOMING bit (bit 11 in Profibus Control Word). Mode 1: Position, Mode 2: Homing
34.03	EXT1 CTRL MODE 1	POSITION	External 1 control mode 1:Position
34.04	EXT1 CTRL MODE 2	HOMING	External 1 control mode 2: Homing
62.01	HOMING METHOD	CAN Methodxx	Selects the homing mode. Select the appropriate CAN Method.
62.03	HOMING START	C.False	Homing start from fieldbus only
65.01	POS REFSOURCE	FIELDBUS	Position reference and speed are read from fieldbus.
65.03	POS START 1	C.False	Position start1 from fieldbus only
65.04	POS 1 REF SEL	FBA REF 1	FBA reference 1 is the position reference source.
65.11	POS START 2	C.False	Position start 2 from fieldbus only.
65.22	PROF VEL REF SEL	FBA REF2	FBA reference 2 is the velocity reference source.

66.05	POS ENABLE	C.False	Position reference generator is enabled by fieldbus only.
70.03	POS REF ENA	C.False	Position reference enable command from fieldbus only
51.01	FBA TYPE	PROFIBUS DP*	Displays the type of the fieldbus adapter module.
51.02	NODE ADDRESS	3**	Profibus node address of the fieldbus module
51.03	BAUDRATE	12000*	Displays current baud rate on the Profibus network.
51.04	TELEGRAM TYPE	4 (= PPO4)*	Displays telegram type selected by PLC configuration tool.
51.05	PROFILE	4 (= PROFIdrive Positioning)	Control Word according to the PROFIdrive Positioning mode
52.01	FBA DATA IN1	4*	Status Word
52.02	FBA DATA IN2	15	Actual value 1
52.04	FBA DATA IN4	16	Actual value 2
53.01	FBA DATA OUT2	1*	Control Word
53.02	FBA DATA OUT2	12	Reference 1
53.04	FBA DATA OUT4	13	Reference 2
51.27	FBA PAR REFRESH	REFRESH	Refreshing parameter settings of the module

*Read-only or automatically detected/set

Note: By default, fieldbus is not the only control source. See actual signal 2.12 FBA MAIN CW in *ACSM1 Motion Control Program Firmware Manual* for details.

The position setpoint is scaled as follows:

Drive parameter	Setting
60.05 POS UNIT (Position unit)	m**
60.08 POS2INT SCALE	100**

****Example**

The position setpoint and actual values are scaled with the above example values as follows:

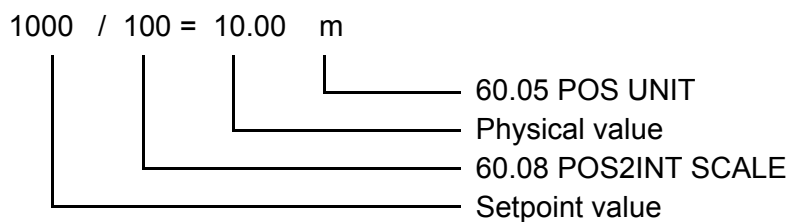

Example for velocity setpoint scale:

Drive parameter	Name	Value	Description
60.10	POS SPEED UNIT	u/s**	Unit/s (in this case m/s)
60.11	POS SPEED2INT	100**	Scales position speed values to integer values. Selections: 1/10/100/1000/ 10000/100000

****Example**

The velocity setpoint and actual values are scaled with the above example values as follows:

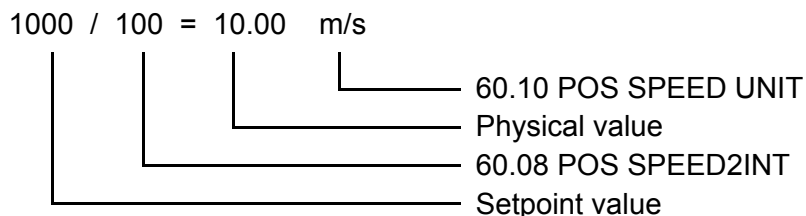

Pay attention to the following parameters:

Group	Description
90	Encoder selection
91/92/93	Settings of the Encoder

The start sequence for above parameter example is given below:

Control word:

406h (1150 decimal) => READY TO SWITCH ON

40Fh (1039 decimal) => OPERATING

43Fh (1087 decimal)=> OPERATING (Do reject traversing task with no intermediate stop)

47Fh (1151 decimal)=> OPERATING (Activate traversing task.)

C0Fh (3087 decimal)=> OPERATING (Start Homing procedure.)

ABB DRIVES communication profile (Speed/Torque Control Mode) with PPO Type 4

The start/stop commands and reference are according to the ABB DRIVES profile Speed Control Mode.

When Reference 1 (REF1) is used, a reference value of ± 20000 (4E20h) corresponds to the reference set by parameter 25.02 SPEED SCALING in the forward and reverse directions.

When Reference 2 (REF2) is used, a reference value of ± 10000 (2710h) corresponds to the reference set by parameter 32.04 TORQUE REF 1 MAX in the forward and reverse directions.

Direction	PZD1	PZD2	PZD3	PZD	PZD	PZD
Out	Control Word	Speed reference	Torque reference	Not used		
In	Status Word	Speed actual value	Torque actual	Not used		

The table below gives the recommended drive parameter settings.

Drive parameter	Name	Setting	Description
50.01	FBA ENABLE	ENABLE	Communication enable between the drive and the fieldbus module
50.04	FBA REF1 MODESEL	SPEED	Fieldbus reference 1 mode selection
50.05	FBA REF2 MODESEL	TORQUE	Fieldbus reference 2 mode selection
10.01	EXT1 START FUNC	FBA	External 1 control source selection
10.04	EXT2 START FUNC	FBA	External 2 control source selection
24.01	SPEED REF1 SEL	FBA REF 1	Fieldbus reference 1 is the source for speed reference 1
32.02	TORQ REF1 SEL	FBA REF 2	Fieldbus reference 2 is the source for Torque reference 1
34.01	EXT1/EXT2 SEL	C.False	External 1 / External 2 selection from fieldbus only (bit 11 in the fieldbus Control Word)
34.03	EXT1 CTRL MODE 1	SPEED	External 1 control mode 1: Speed
34.05	EXT2 CTRL MODE 1	TORQUE	External 2 control mode 1: Torque
51.01	FBA TYPE	PROFIBUS DP*	Displays the type of the fieldbus adapter module.
51.02	NODE ADDRESS	3**	Profibus node address of the fieldbus module.
51.03	BAUDRATE	12000*	Displays current baud rate on the Profibus network.
51.04	TELEGRAM TYPE	4 (= PPO4)*	Displays telegram type selected by the PLC configuration tool.

51.05	PROFILE	1(= ABB Drives)	Control Word according to the ABB Drives profile.
52.01	FBA DATA IN1	4*	Status Word (PZD 1)
52.02	FBA DATA IN2	5	Actual value 1
52.03	FBA DATA IN3	6	Actual value 2
53.01	FBA DATA OUT2	1*	Control Word
53.02	FBA DATA OUT2	2	Reference 1
53.03	FBA DATA OUT3	3	Reference 2
51.27	FBA PAR REFRESH	REFRESH	Refreshing parameter settings of the module

*Read-only or automatically detected/set

**Example

The start sequence for the parameter example above is given below.

Control Word:

47Eh (1150 decimal) => READY TO SWITCH ON

47Fh (1151 decimal) => OPERATING (Speed mode)

C7Fh (3199 decimal)=> OPERATING (Torque mode).

Parameter setting examples – ACS850 and ACQ810

*PROFIdrive communication profile (Speed Control Mode)
with PPO Type 1*

The start/stop commands and reference are according to the PROFIdrive profile *Speed Control Mode*. (See the PROFIBUS state machine on page 61.) The reference value ± 16384 (4000h) corresponds to parameter 19.01 Speed scaling in forward and reverse directions.

Direction	PZD1	PZD2
Out	Control Word	Speed Reference
In	Status Word	Speed Actual value

The table below gives the recommended drive parameter settings.

Drive parameter	Setting
50.01 FBA enable	Enable
50.04 FBA ref1 modesel	Speed
10.01 Ext1 start func	FBA
21.01 Speed ref1 sel (ACS850) 21.01 Speed ref sel (ACQ810)	FBA ref1 FBA ref1
51.01 FBA type	1 = FPBA-xx PROFIBUS DP adapter module (ACS850)* 1 = PROFIBUS DP (ACQ810)*
51.02 NODE ADDRESS	3
51.03 BAUDRATE	12000*
51.04 TELEGRAM TYPE	1 (= PPO 1)*
51.05 PROFILE	0 (= PROFIdrive)
52.01 FBA data in1	4*
52.02 FBA data in2	5
53.01 FBA data out1	1*
53.02 FBA data out2	2
51.27 FBA par refresh	Refresh
*Read-only or automatically detected/set	

Mechanical installation



WARNING! Follow the safety instructions given in this manual and the drive documentation.

Mounting

The FPBA-01 is to be inserted into its specific position in the drive. The module is held in place with plastic pins and one screw. The screw also provides the earthing of the fieldbus cable shield connected to the module.

On installation of the module, the signal and power connection to the drive is made through a 20-pin connector. (All drives do not use all the available signals so the connector on the drive may have fewer pins.)

Mounting procedure:

- Insert the module carefully into its position on the drive.
- Fasten the screw.

Note: Correct installation of the screw is essential for fulfilling the EMC requirements and for proper operation of the module.

Electrical installation

Overview

This chapter contains:

- general cabling instructions
- instructions for setting module node address number and bus termination
- instructions for connecting the module to the PROFIBUS DP network.



WARNING! Before installation, switch off the drive power supply. Wait five minutes to ensure that the capacitor bank of the drive is discharged. Switch off all dangerous voltages connected from external control circuits to the inputs and outputs of the drive.

General cabling instructions

Arrange the bus cables as far away from the motor cables as possible. Avoid parallel runs. Use bushings at cable entries.

PROFIBUS connection

The bus cable is connected to connector X1 on the FPBA-01.

The connector pin allocation described below follows the PROFIBUS standard.

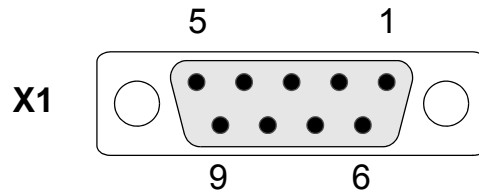

X1		Description
1	SHLD	Alternate cable shield connection. Connected to connector housing.
2		Not used
3	B	Data positive (Conductor 1 in twisted pair).
4	RTS	Request To Send
5	GND_B	Isolated ground
6	+5V_B	Isolated 5V DC voltage supply (30 mA max.)
7		Not used
8	A	Data negative (Conductor 2 in twisted pair).
9		Not used
Housing	SHLD	PROFIBUS cable shield. Internally connected to GND_B via an RC filter and directly to CH_GND (chassis).

+5V and GND BUS are used for bus termination.

RTS is used in some equipment to determine the direction of transmission. In typical applications, only the line A, line B and shield are used.

It is recommended to use a PROFIBUS-approved D-SUB 9 connector. These connectors have a built-in termination network and inductors for station capacitance compensation. The cable should be connected to the D-SUB connector as follows:

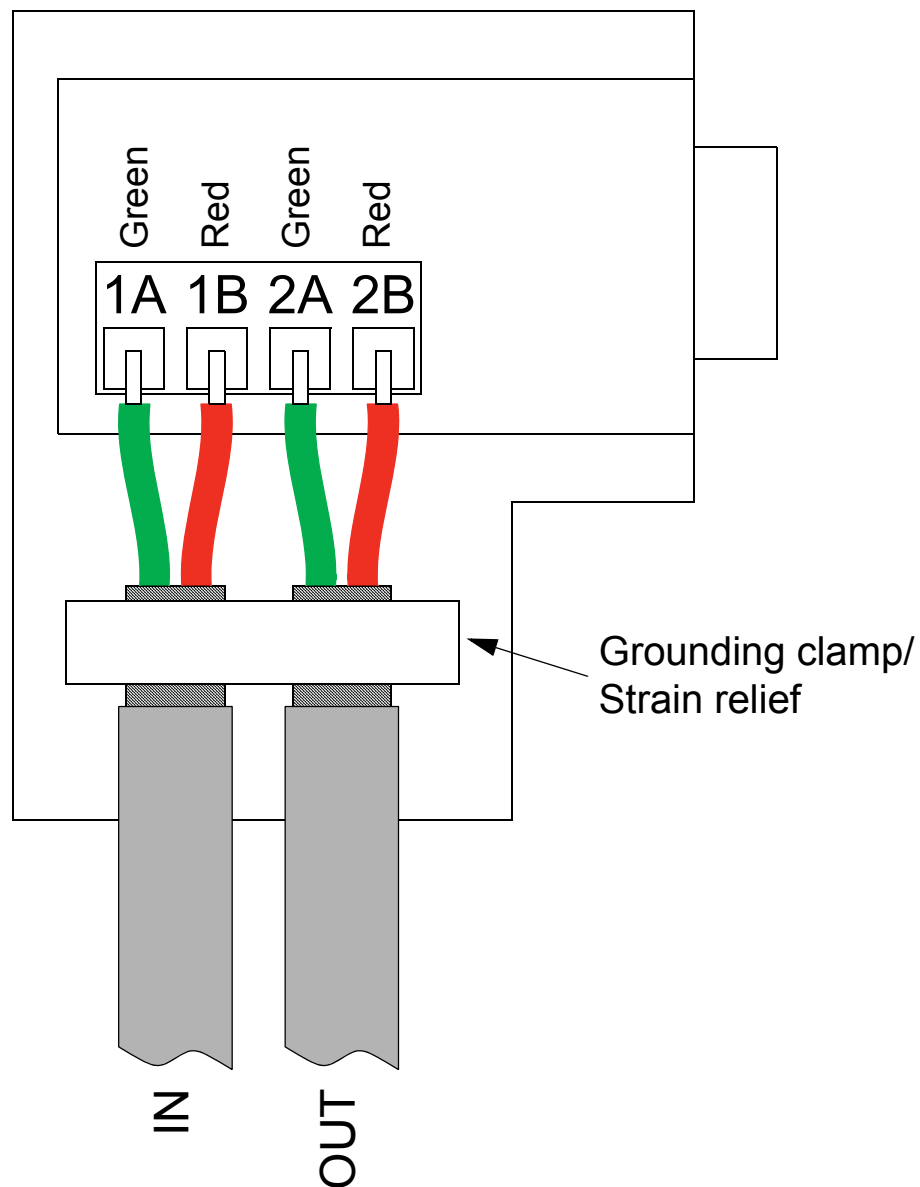

Figure 2. Connector wiring

Bus termination

Bus termination is required to prevent signal reflections from the bus cable ends. The FPBA-01 module is not equipped with internal bus termination. Therefore, the D-SUB connectors at the first and last modules of the bus must have built-on termination switched on. See the diagram below.

The FPBA-01 module is able to supply power for an active-type termination circuitry (30 mA max.).

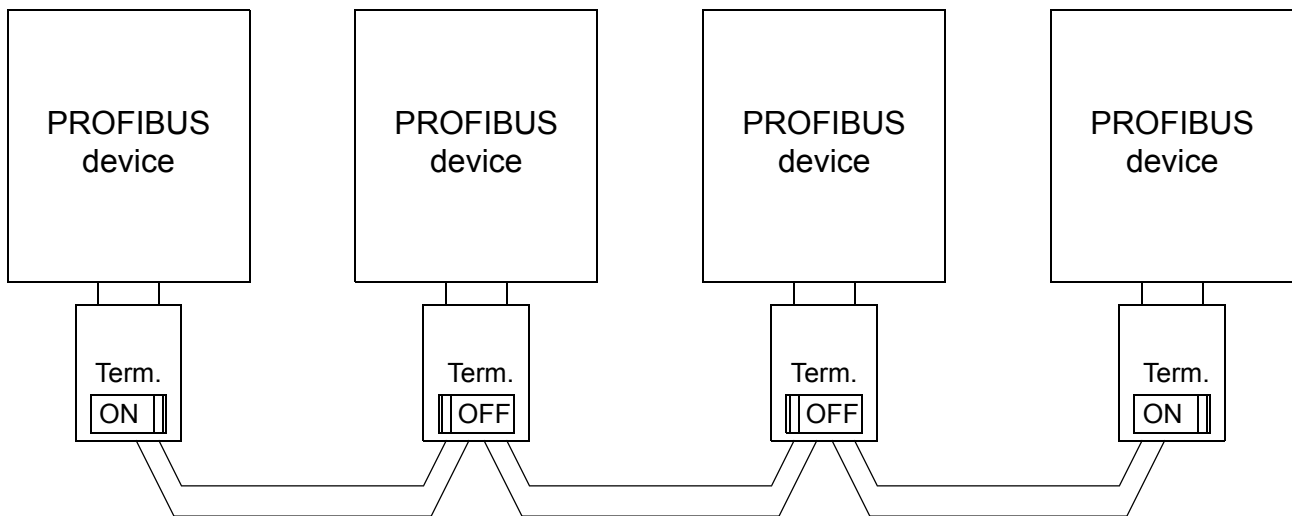

Figure 3. PROFIBUS cable termination

Note: Further information on PROFIBUS wiring is available from the publication “PROFIBUS RS 485-IS User and Installation Guideline” (www.profibus.com, order no. 2.262).

Drive configuration

Overview

This chapter gives information on configuring the drive for communication through the FPBA-01 PROFIBUS DP Adapter module.

PROFIBUS connection configuration

After the FPBA-01 PROFIBUS DP Adapter module has been mechanically and electrically installed according to the instructions in previous chapters, the drive must be prepared for communication with the module.

The detailed procedure of activating the module for PROFIBUS DP communication with the drive is dependent on the drive type. Normally, a parameter must be adjusted to activate the communication (see the drive documentation).

As communication between the drive and the FPBA-01 is established, several configuration parameters are copied to the drive. These parameters – shown below in Tables 1 to 3 – must be checked first and adjusted where necessary. The alternative selections for these parameters are discussed in more detail below the tables.

Note: The new settings take effect only when the module is powered up the next time or when a 'Fieldbus Adapter parameter refresh' command is given (see the drive documentation).

Data transfer rates supported

The FPBA-01 supports the following PROFIBUS communication speeds: 9.6 kbit/s, 19.2 kbit/s, 45.45 kbit/s, 93.75 kbit/s, 187.5 kbit/s, 500 kbit/s, 1.5 Mbit/s, 3 Mbit/s, 6 Mbit/s, 12 Mbit/s.

The FPBA-01 automatically detects the communication speed and telegram type used.

Table 1. FPBA-01 configuration parameters – Group A (Group 1)*

Par. no.	Parameter name	Alternative settings	Default setting
1	FBA TYPE	(Read-only)	PROFIBUS DP
2	NODE ADDRESS	0 to 126	3
3	BAUD RATE**	(12000) 12 Mbit/s; (6000) 6 Mbit/s; (3000) 3 Mbit/s; (1500) 1.5 Mbit/s; (500) 500 kbit/s; (187) 187.5 kbit/s; (93) 93.75 kbit/s; (45) 45.45 kbit/s; (19) 19.2 kbit/s; (9) 9.6 kbit/s	1500
4	TELEGRAM TYPE**	(1) PPO 1; (2) PPO 2; (3) PPO 3; (4) PPO 4; (5) PPO 5; (6) PPO 6; (7) ST1; (8) ST2*** (Read-only)	(1) PPO 1
5	PROFILE	(0) PROFIdrive; (1) ABB Drives; (2) Transparent 16; (3) Transparent 32***; (4) PROFIdrive positioning mode***	(1) ABB Drives
6	T16 SCALE	1 to 65535	100

*Actual parameter group number depends on the drive type. E.g. group A (group 1) equals to parameter group 51 in ACS350, ACS355, ACSM1, ACS850 and ACQ810.

**The value is automatically updated (Read-only).

***Only supported with an ACSM1 drive.

Note: Set also the extended Parameter Data (see SAP 61 in the chapter [Communication](#)) to ensure proper operation of the FPBA-01 with the drive.

1 FBA TYPE

This parameter shows the fieldbus adapter type as detected by the drive. The value cannot be adjusted by the user.

If this parameter is undefined, the communication between the drive and the module has not been established.

2 NODE ADDRESS

Each device on the PROFIBUS network must have a unique node number. This parameter is used to define a node number for the drive it is connected to. Recommended node numbers are 3 to 125 inclusive.

3 BAUD RATE

This parameter indicates the detected communication speed in kbit/s.

12000	=	12	Mbit/s
6000	=	6	Mbit/s
3000	=	3	Mbit/s
1500	=	1.5	Mbit/s
500	=	500	kbit/s
187	=	187.5	kbit/s
93	=	93.75	kbit/s
45	=	45.45	kbit/s
19	=	19.2	kbit/s
9	=	9.6	kbit/s

4 TELEGRAM TYPE

This parameter indicates the selected telegram type for the PROFIBUS communication. The FPBA-01 automatically detects the telegram type used, and supports PPO messages 1 to 6 and standard telegrams (ST) 1 and 2.

See Figure 8 in the chapter *Communication* for more information on the supported PPO message types.

If STs are used, parameter 5 (PROFILE) is automatically set. ST2 is only supported with an ACSM1 drive.

5 PROFILE

This parameter is used to select which communication profile is used. The FPBA-01 supports the PROFIdrive, ABB Drives and Transparent 16 profiles. With an ACSM1 drive, a PROFIdrive positioning mode and the Transparent 32 profile are also supported.

More information on the communication profiles can be found in the chapter *Communication profiles*.

6 T16 SCALE

Reference multiplier/actual value divisor for the FPBA-01. The parameter is effective only when the Transparent 16 profile is selected AND the drive is using the DCU communication profile.

With ACS350 and ACS355, the speed reference from the PLC is multiplied by the value of this parameter. For example, with the default setting of 100, a reference of 1,000 is forwarded to the drive as 100,000. According to the DCU profile, this value is interpreted as a reference of 100 rpm.

With an ACSM1, setting this parameter to 65535 will provide the practically exact approximation of $1 \approx 1$ rpm.

Table 2. FPBA-01 configuration parameters – Group B (Group 2)*

Par. no.	Parameter name	Alternative settings	Default setting
1	DATA OUT 1 (master to drive)	0 to 9999 Format: xyyy , where xx = parameter group and yy = parameter index.	1 (Control word) or 11 (Control word 32-bit)**
2	DATA OUT 2	See DATA OUT 1 above.	0 or 2 (REF1)***
3	DATA OUT 3	See DATA OUT 1 above.	0
4	DATA OUT 4	See DATA OUT 1 above.	0
5	DATA OUT 5	See DATA OUT 1 above.	0
6	DATA OUT 6	See DATA OUT 1 above.	0
7	DATA OUT 7	See DATA OUT 1 above.	0
8	DATA OUT 8	See DATA OUT 1 above.	0
9	DATA OUT 9	See DATA OUT 1 above.	0
10	DATA OUT 10	See DATA OUT 1 above.	0
11	DATA OUT 11****	See DATA OUT 1 above.	0
12	DATA OUT 12****	See DATA OUT 1 above.	0

*Actual parameter group number depends on the drive type. E.g. group B (group 2) equals to parameter group 55 in ACS350 and ACS355, and group 53 in ACSM1, ACS850 and ACQ810.

**Default setting if the Transparent 32 profile is used.

***Fixed setting with ACS350 and ACS355 drives.

****Supported only with an ACSM1/ACS850/ACQ810 drive.

1 DATA OUT 1

This parameter represents data word 1 received by the drive over the PROFIBUS network. The content is defined by a decimal number in the range of 0 to 9999 as follows:

0	not used
1...99	virtual address area of drive control

101...9999	parameter area of the drive
------------	-----------------------------

The virtual address area of the drive control is allocated as follows:

Virtual address	Description	Data length	DATA IN only
1	Control word*	16-bit	
2	Reference 1 (REF1)*	16-bit	
3	Reference 2 (REF2)*	16-bit	
4	Status word	16-bit	X
5	Actual value 1 (ACT1)	16-bit	X
6	Actual value 2 (ACT2)	16-bit	X
7...10	Reserved		
11	Control word	32-bit	
12	Reference 1 (REF1)	32-bit	
13	Reference 2 (REF2)	32-bit	
14	Status word	32-bit	X
15	Actual value 1 (ACT1)	32-bit	X
16	Actual value 2 (ACT2)	32-bit	X
17...20	Reserved		
21	Control word 2 (STW2)	16-bit	
22, 23	Reserved		
24	Status word 2 (ZSW2)	16-bit	X
25...99	Reserved		
99	Reserved		

*With ACS350 and ACS355 drives, Control word and Reference 1 are always fixed to virtual addresses 1 and 2 respectively. If REF2 is used, its virtual address is always 3.

When the PROFIdrive profile or PROFIdrive positioning mode (see parameter group A, parameter number 5 “PROFILE” on page 42) is used with an ACSM1 drive, the virtual addresses shown below are recommended. (FBA REFx mode is selected with ACSM1 drive parameter 50.04/50.05.)

The information in the table is applicable only if PPO messaging is used (see parameter group A, parameter number 4 “TELEGRAM TYPE” on page 42). If standard telegrams (STx) are used, virtual addresses for standard telegrams (ST1 and ST2) are updated automatically.

Abbreviation	Description	Data length	Recommended virtual address with ACSM1 FBA REFx modes	
			Speed mode	Position mode
STW1	Control word 1	16-bit	1	1
NSOLL_A	Speed setpoint A	16-bit	2 or 3	
NSOLL_B	Speed setpoint B	32-bit	12 or 13	
STW2	Control word 2	16-bit	21	21
XSOLL_A	Position setpoint A	32-bit		12 or 13
VELOCITY_A	Velocity	32-bit		13
ZSW2	Status word 2	16-bit	24	24
NIST_A	Speed actual value A	16-bit	5 or 6	
NIST_B	Speed actual value B	32-bit	15 or 16	
ZSW1	Status word 1	16-bit	4	4
XIST_A	Position actual value A	32-bit		15 or 16

The parameter area is allocated as follows:

Parameter number with format xxyy, where xx is the parameter group number (1 to 99) and yy is the parameter number index within that group (01 to 99).

2 to 12 DATA OUT 2 to DATA OUT 12

See parameter 1 above.

Table 3. FPBA-01 configuration parameters – Group C (Group 3)*

Par. no.	Parameter name	Alternative settings	Default setting
1	DATA IN 1 (drive to master)	0 to 9999 Format: xyy , where xx = parameter group and yy = parameter index.	4 (Status word) or 14 (Status word 32-bit)**
2	DATA IN 2**	See DATA IN 1 above.	0 or 5 (ACT1)***
3	DATA IN 3	See DATA IN 1 above.	0
4	DATA IN 4	See DATA IN 1 above.	0
5	DATA IN 5	See DATA IN 1 above.	0
6	DATA IN 6	See DATA IN 1 above.	0
7	DATA IN 7	See DATA IN 1 above.	0
8	DATA IN 8	See DATA IN 1 above.	0
9	DATA IN 9	See DATA IN 1 above.	0
10	DATA IN 10	See DATA IN 1 above.	0
11	DATA IN 11****	See DATA IN 1 above.	0
12	DATA IN 12****	See DATA IN 1 above.	0

*Actual parameter group number depends on the drive type. E.g. group C (group 3) equals to parameter group 54 in ACS350 and ACS355, and group 52 in ACSM1, ACS850 and ACQ810.

**Default setting if the Transparent 32 profile is used.

***Fixed setting with ACS350 and ACS355 drives.

****Supported only with an ACSM1/ACS850/ACQ810 drive.

1 DATA IN 1

This parameter represents data word 1 sent by the drive over the PROFIBUS network. For the contents, see configuration parameter group B, parameter 1 (DATA OUT 1) on page 45.

2 to 12 DATA IN 2 to DATA IN 12

See parameter 1 above.

Control locations

ABB drives can receive control information from multiple sources including digital inputs, analogue inputs, the drive control panel and a communication module (e.g. FPBA-01). ABB drives allow the user to separately determine the source for each type of control information (Start, Stop, Direction, Reference, Fault Reset, etc.). In order to give the fieldbus master station the most complete control over the drive, the communication module must be selected as source for this information. See the user documentation of the drive for information on the selection parameters.

Master configuration

Overview

This chapter gives information on configuring the PROFIBUS master station for communication through the FPBA-01 PROFIBUS Adapter module.

Configuring the system

After the FPBA-01 PROFIBUS DP Adapter module has been mechanically and electrically installed according to the instructions in previous chapters, and has been initialised by the drive, the master station must be prepared for communication with the module.

Configuration of the master station requires a type definition (GSD) file.

For DP-V0 communication, the file is available from profibus website or your local ABB representative (the filename is **ABB_0959.GSD**).

For DP-V1 communication, the file is available from your local ABB representative (the filename is **ABB10959.GSD**).

Please refer to the master station documentation for more information.

Communication profiles

Overview

This chapter describes the communication profiles used in the communication between the PROFIBUS network, the FPBA-01 module, and the drive.

Communication profiles

Communication profiles are ways of conveying control commands (Control word, Status word, references and actual values) between the master station and the drive.

With the FPBA-01 module, the PROFIBUS network may employ either the PROFIdrive profile or the ABB Drives profile. Both are converted to the DCU/FBA profile (detailed in the drive documentation) by the FPBA-01 module. In addition, two Transparent modes – for 16-bit and 32-bit words respectively – are available. With the Transparent modes, no data conversion takes place.

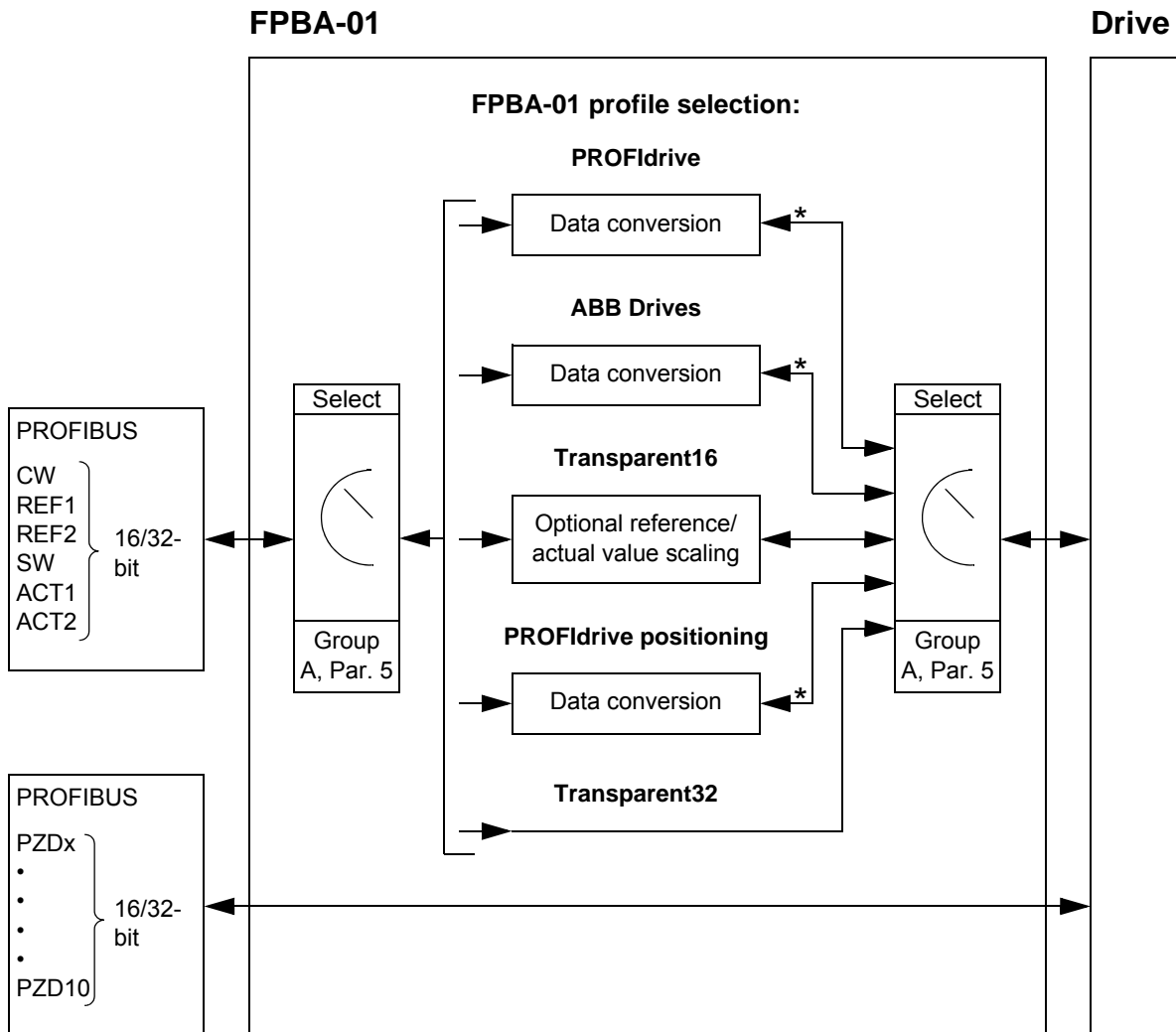

Note: The diagram is applicable only when PPO messaging is used. If Standard Telegrams (ST) are used, the communication profile is selected automatically.

*DCU or FBA profile

The following sections describe the Control word, the Status word, references and actual values for the PROFIdrive and ABB Drives communication profiles. Refer to the drive manuals for details on the DCU communication profile.

The PROFIdrive communication profile

The Control Word and the Status Word

The Control Word (PROFIBUS Parameter 967) is the principal means for controlling the drive from a fieldbus system. It is sent by the fieldbus master station to the drive through the adapter module. The drive switches between its states according to the bit-coded instructions on the Control Word, and returns status information to the master in the Status Word (PROFIBUS Parameter 968).

The contents of the Control Word and the Status Word are detailed in Tables 4 and 5 respectively; see the drive documentation for information on the drive-specific bits. The drive states are presented in the PROFIBUS State Machine (Figure 4). The drive states for positioning mode are presented in Figure 5.

References

ABB drives can receive control information from multiple sources including analogue and digital inputs, the drive control panel and a communication module (e.g. FPBA-01). In order to have the drive controlled through PROFIBUS, the communication module must be defined as the source for control information, e.g. Reference.

References in speed control mode

In speed control mode, references are 16-bit or 32-bit words containing a sign bit and a 15-bit or 31-bit integer. A negative reference (indicating reversed direction of rotation) is formed by calculating the two's complement from the corresponding positive reference.

A 16-bit speed reference (REF or NSOLL_A) in hexadecimal (0 ... 4000h) corresponds to 0 ... 100% of Maximum Reference (as defined by a drive parameter).

A 32-bit speed reference (NSOLL_B) in hexadecimal (0 ... 4000 0000h) corresponds to 0 ... 100% of Maximum Reference (as defined by a drive parameter).

References in positioning mode (with an ACSM1 drive only)

In positioning mode, references are 16-bit or 32-bit words. A 32-bit reference contains a sign bit and a 31-bit integer. A negative reference (indicating reversed direction of rotation) is formed by calculating the two's complement from the corresponding positive reference.

For a 32-bit position reference (XSOLL_A), the unit and scaling are defined by drive parameters (e.g. POS UNIT, POS2INT SCALE and FEED CONST).

For a 32-bit velocity reference (VELOCITY_A), the unit and scaling are defined by drive parameters (e.g. POS SPEED UNIT and POS SPEED2INT).

Actual values

Actual values are 16-bit or 32-bit words containing information on the operation of the drive. The functions to be monitored are selected by a drive parameter.

Actual values in speed control mode

The scaling of 16-bit actual speed values (ACT or NIST_A) in hexadecimal (0 ... 4000h) corresponds to 0 ... Maximum Reference (as defined by a drive parameter).

The scaling of 32-bit actual speed values (NIST_B) in hexadecimal (0 ... 4000 0000h) corresponds to 0 ... 100% of Maximum Reference (as defined by a drive parameter).

Actual values in positioning mode (with an ACSM1 drive only)

For a 32-bit actual position value (XIST_A), the unit and scaling are defined by drive parameters (e.g. POS UNIT, POS2INT SCALE and FEED CONST).

Table 4. The Control Word for the PROFdrive communication profile (PROFIBUS Parameter 967). The upper case boldface text refers to the states shown in Figure 4.

Bit	Name	Value	Proceed to STATE/Description	
			Speed control mode	Positioning mode
0	ON	1	Proceed to READY TO OPERATE .	
	OFF1	0	Emergency OFF, stop by the selected deceleration ramp. Proceed to OFF1 ACTIVE ; proceed further to READY TO SWITCH ON unless other interlocks (OFF2, OFF3) are active.	
1	OFF2	1	Continue operation (OFF2 inactive).	
		0	Emergency OFF, coast to stop. Proceed to OFF2 ACTIVE ; proceed further to SWITCH-ON INHIBIT .	
2	OFF3	1	Continue operation (OFF3 inactive).	
		0	Emergency stop, stop according to fastest possible deceleration mode. Proceed to OFF3 ACTIVE ; proceed further to SWITCH-ON INHIBIT . Warning: Ensure motor and driven machine can be stopped using this stop mode.	
3	OPERATION_ENABLE	1	Proceed to ENABLE OPERATION .	
		0	Inhibit operation. Proceed to OPERATION INHIBIT .	
4	ENABLE_RAMP_GENERATOR	1	Normal operation. Proceed to RAMP FUNCTION GENERATOR: ENABLE OUTPUT .	Normal operation. Do not reject traversing task.
	or TRAVERSING_TASK	0	Stop according to selected stop type.	Reject traversing task.

Bit	Name	Value	Proceed to STATE/Description	
			Speed control mode	Positioning mode
5		1	Normal operation. Proceed to RAMP FUNCTION GENERATOR: ENABLE ACCELERATOR.	Normal operation. No intermediate stop.
		0	Halt ramping (Ramp Function Generator output held).	Intermediate stop.
6		1	Normal operation. Proceed to OPERATING. Note: This bit is effective only if the fieldbus interface is set as the source for this signal by drive parameters.	Activate traversing task (0 ⇒ 1). This is a toggle bit; each rising edge of signal enables a traversing task or a new setpoint.
		0	Force Ramp Function Generator input to zero.	
7	RESET	0 ⇒ 1	Fault reset if an active fault exists. Proceed to SWITCH-ON INHIBIT. Note: This bit is effective only if the fieldbus interface is set as the source for this signal by drive parameters.	
		0	(Continue normal operation)	
8	JOGGING_1		Jogging 1. (Not supported by all drive types)	
9	JOGGING_2		Jogging 2. (Not supported by all drive types)	
10	REMOTE_CMD	1	Fieldbus control enabled.	
		0	Control Word <> 0 or Reference <> 0: Retain last Control Word and Reference. Control Word = 0 and Reference = 0: Fieldbus control enabled.	
11		1	Vendor-specific bit as defined by PROFIdrive parameter 933.	Start homing procedure.
		0		Stop homing procedure.
12			Vendor-specific bit as defined by PROFIdrive parameter 934.	

Communication profiles

Bit	Name	Value	Proceed to STATE/Description	
			Speed control mode	Positioning mode
13			Vendor-specific bit as defined by PROFIdrive parameter 935.	
14			Vendor-specific bit as defined by PROFIdrive parameter 936.	
15			Vendor-specific bit as defined by PROFIdrive parameter 937.	

Table 5. The Status Word for the PROFIdrive communication profile (PROFIBUS Parameter 968). The upper case boldface text refers to the states shown in [Figure 4](#).

Bit	Name	Value	STATE/Description	
			Speed control mode	Positioning mode
0	RDY_ON	1	READY TO SWITCH ON.	
		0	NOT READY TO SWITCH ON.	
1	RDY_RUN	1	READY TO OPERATE.	
		0	OFF1 ACTIVE.	
2	RDY_REF	1	ENABLE OPERATION.	
		0	DISABLE OPERATION.	
3	TRIPPED	1	FAULT.	
		0	No fault.	
4	OFF_2_STA	1	OFF2 inactive.	
		0	OFF2 ACTIVE.	
5	OFF_3_STA	1	OFF3 inactive.	
		0	OFF3 ACTIVE.	
6	SWC_ON_INHIB	1	SWITCH-ON INHIBIT ACTIVE.	
		0	SWITCH-ON INHIBIT NOT ACTIVE.	
7	ALARM	1	Warning/Alarm.	
		0	No Warning/Alarm.	

Bit	Name	Value	STATE/Description	
			Speed control mode	Positioning mode
8	AT_SETPOINT	1	OPERATING. Actual value equals reference value (i.e. is within tolerance limits).	
		0	Actual value differs from reference value (= is outside tolerance limits).	
9	REMOTE	1	Drive control location: REMOTE.	
		0	Drive control location: LOCAL.	
10		1	Actual frequency or speed value equals or is greater than supervision limit.	Target position reached.
		0	Actual frequency or speed value is within supervision limit.	Not at target position.
11		1	Vendor-specific bit as defined by PROFIdrive parameter 939.	Homing procedure was executed and is valid.
		0		No valid home position available.
12		1	Vendor-specific bit as defined by PROFIdrive parameter 940.	Traversing task acknowledgement (0 ⇒ 1).
		0		
13		1	Vendor-specific bit as defined by PROFIdrive parameter 941.	Drive stopped.
		0		Drive moving. Traversing task is executed (n <> 0).
14			Vendor-specific bit as defined by PROFIdrive parameter 942.	
15			Vendor-specific bit as defined by PROFIdrive parameter 943.	

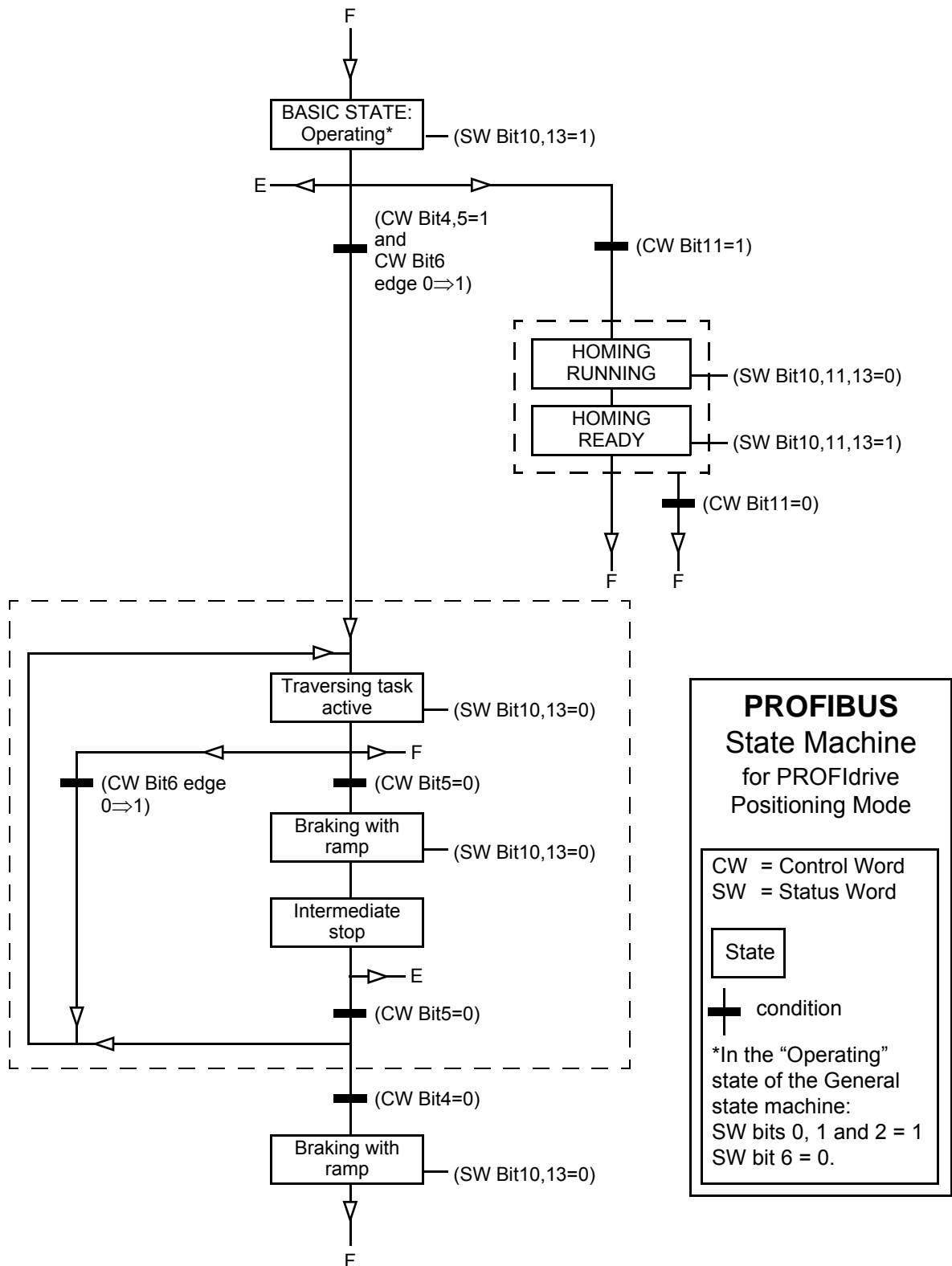

Figure 5. The PROFIBUS state machine for positioning mode

The ABB Drives communication profile

The Control Word and the Status Word

The Control Word is the principal means for controlling the drive from a fieldbus system. It is sent by the fieldbus master station to the drive through the adapter module. The drive switches between its states according to the bit-coded instructions on the Control Word, and returns status information to the master in the Status Word.

The contents of the Control Word and the Status Word are detailed in Tables 6 and 7 respectively. The drive states are presented in the ABB Drives profile state machine (Figure 6).

References

References are 16-bit words containing a sign bit and a 15-bit integer. A negative reference (indicating reversed direction of rotation) is formed by calculating the two's complement from the corresponding positive reference.

ABB drives can receive control information from multiple sources including analogue and digital inputs, the drive control panel and a communication module (e.g. FPBA-01). In order to have the drive controlled through the fieldbus, the module must be defined as the source for control information, e.g. Reference.

Scaling

References are scaled as shown below.

Note: The values of REF1 MAX and REF2 MAX are set by drive parameters. See the drive documentation for further information.

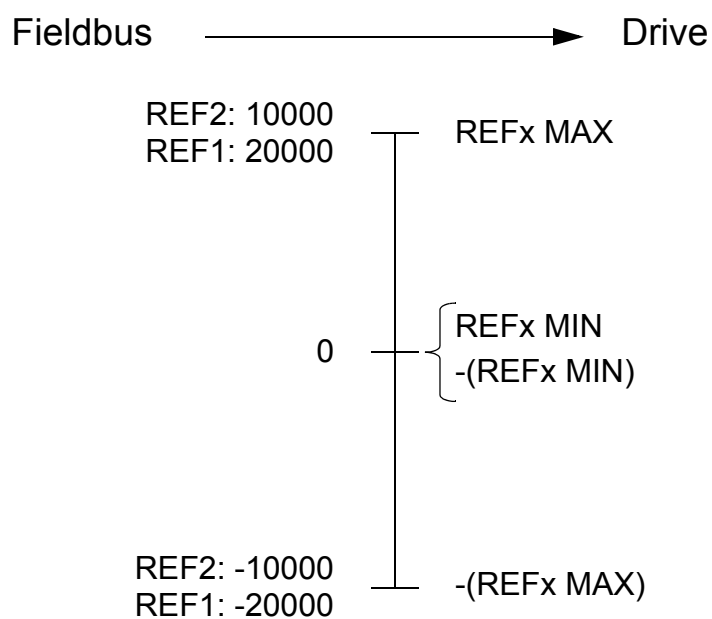

Actual values

Actual values are 16-bit words containing information on the operation of the drive. The functions to be monitored are selected by a drive parameter.

Scaling

Actual values are scaled as shown below.

Note: The values of REF1 MAX and REF2 MAX are set by drive parameters. See the drive documentation for further information.

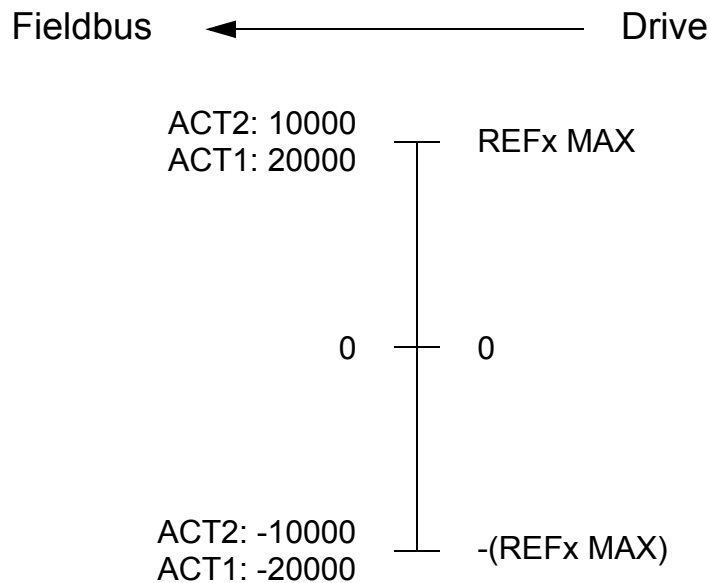

Table 6. The Control Word for the ABB Drives communication profile. The upper case boldface text refers to the states shown in Figure 4.

Bit	Name	Value	STATE/Description
0	OFF1_ CONTROL	1	Proceed to READY TO OPERATE .
		0	Stop along currently active deceleration ramp. Proceed to OFF1 ACTIVE ; proceed to READY TO SWITCH ON unless other interlocks (OFF2, OFF3) are active.
1	OFF2_ CONTROL	1	Continue operation (OFF2 inactive).
		0	Emergency OFF, coast to stop. Proceed to OFF2 ACTIVE , proceed to SWITCH-ON INHIBITED .
2	OFF3_ CONTROL	1	Continue operation (OFF3 inactive).
		0	Emergency stop, stop within time defined by drive parameter. Proceed to OFF3 ACTIVE ; proceed to SWITCH-ON INHIBITED . Warning: Ensure motor and driven machine can be stopped using this stop mode.
3	INHIBIT_ OPERATION	1	Proceed to OPERATION ENABLED . Note: Run enable signal must be active; see drive documentation. If the drive is set to receive the Run enable signal from the fieldbus, this bit activates the signal.
		0	Inhibit operation. Proceed to OPERATION INHIBITED .
4	RAMP_OUT_ ZERO	1	Normal operation. Proceed to RAMP FUNCTION GENERATOR: OUTPUT ENABLED .
		0	Force Ramp Function Generator output to zero. Drive ramps to stop (current and DC voltage limits in force).

Bit	Name	Value	STATE/Description
5	RAMP_HOLD	1	Enable ramp function. Proceed to RAMP FUNCTION GENERATOR: ACCELERATOR ENABLED.
		0	Halt ramping (Ramp Function Generator output held).
6	RAMP_IN_ZERO	1	Normal operation. Proceed to OPERATING. Note: This bit is effective only if the fieldbus interface is set as the source for this signal by drive parameters.
		0	Force Ramp Function Generator input to zero.
7	RESET	0=>1	Fault reset if an active fault exists. Proceed to SWITCH-ON INHIBITED. Note: This bit is effective only if the fieldbus interface is set as the source for this signal by drive parameters.
		0	Continue normal operation.
8 to 9	Reserved.		
10	REMOTE_CMD	1	Fieldbus control enabled.
		0	Control Word <> 0 or Reference <> 0: Retain last Control Word and Reference. Control Word = 0 and Reference = 0: Fieldbus control enabled. Reference and deceleration/acceleration ramp are locked.
11	EXT_CTRL_LOC	1	Select External Control Location EXT2. Effective if control location parameterised to be selected from fieldbus.
		0	Select External Control Location EXT1. Effective if control location parameterised to be selected from fieldbus.
12 to 15	Drive-specific (For information, see the drive documentation.)		

Table 7. The Status Word for the ABB Drives communication profile. The upper case boldface text refers to the states shown in Figure 6.

Bit	Name	Value	STATE/Description
0	RDY_ON	1	READY TO SWITCH ON.
		0	NOT READY TO SWITCH ON.
1	RDY_RUN	1	READY TO OPERATE.
		0	OFF1 ACTIVE.
2	RDY_REF	1	OPERATION ENABLED.
		0	OPERATION INHIBITED.
3	TRIPPED	1	FAULT.
		0	No fault.
4	OFF_2_STA	1	OFF2 inactive.
		0	OFF2 ACTIVE.
5	OFF_3_STA	1	OFF3 inactive.
		0	OFF3 ACTIVE.
6	SWC_ON_INHIB	1	SWITCH-ON INHIBITED.
		0	–
7	ALARM	1	Warning/Alarm.
		0	No warning/alarm.
8	AT_SETPOINT	1	OPERATING. Actual value equals reference = is within tolerance limits, i.e. in speed control, speed error is 10% max. of nominal motor speed.
		0	Actual value differs from reference = is outside tolerance limits.
9	REMOTE	1	Drive control location: REMOTE (EXT1 or EXT2).
		0	Drive control location: LOCAL.

Bit	Name	Value	STATE/Description
10	ABOVE_ LIMIT	1	Actual frequency or speed equals or exceeds supervision limit (set by drive parameter). Valid in both directions of rotation.
		0	Actual frequency or speed within supervision limit.
11	EXT_CTRL_ LOC	1	External Control Location EXT2 selected.
		0	External Control Location EXT1 selected.
12	EXT_RUN_ ENABLE	1	External Run Enable signal received.
		0	No External Run Enable signal received.
13 to 14	Drive-specific (For information, see the drive documentation.)		
15	FBA_ERROR	1	Communication error detected by fieldbus adapter module.
		0	Fieldbus adapter communication OK.

Communication

Overview

This chapter describes the PROFIBUS messaging used in the communication with the drive, and PROFIBUS slave device configuration messages.

PROFIBUS DP

The FPBA-01 module supports the PROFIBUS DP (DP-V0) protocol according to the IEC 61784 and EN 50170 standards. PROFIBUS DP-V0/DP-V1 is a distributed I/O system which enables the master to use a large number of peripheral modules and field devices. The data transfer is mainly cyclic: the master reads the input information from the slaves and sends the output information back to the slaves.

The FPBA-01 module uses so-called PPOs (*Parameter/Process Data Objects*) in cyclic communication and supports also standard telegrams 1 and 2. See Figures 8 and 9 for the supported PPO messages and standard telegrams respectively.

Service Access Points (SAPs)

The services of the PROFIBUS Data Link Layer (Layer 2) are used by PROFIBUS DP through Service Access Points (SAPs). Precisely defined functions are assigned to individual SAPs.

For further information on Service Access Points, refer to the manual of the PROFIBUS master, *PROFIDRIVE – The PROFIBUS Profile for Adjustable Speed Drives V2.0 and V3.1*, or the EN 50170 and IEC 61784 standards.

Communication start-up

The following Service Access Points (SAPs) are used to initiate DP communication:

SAP no.	Short Name	Name
Default SAP (0)	Data_Exch	Cyclical Data Exchange (Write_Read_Data)
58	Global_Control	Global Control Service
59	Get_Cfg	Read Configuration Data
60	Slave_Diag	Read Diagnostic Data
61	Set_Prm	Send Parameter Data
62	Chk_Cfg	Check Configuration Data

PROFIBUS SD2 telegram for Default SAP (0) and SAP 58-62

PROFIBUS typically uses SD2 telegrams for DP communication.
The structure of an SD2 telegram is shown below.

DP header									DP trailer		
SD	LE	LEr	SD	DA	SA	FC	*DSAP	*SSAP	DU	FCS	ED
68h	x	x	68h	xx	xx	x	xx	xx	x...	xx	16h

SD = Start Delimiter

LE = Length

LEr = Length repeated

DA = Destination Address

SA = Source Address

FC = Function Code

*DSAP = Destination Service Access Point

*SSAP = Source Service Access Point

DU = Data Unit for DP services

FCS = Frame Checking Sequence

ED = End Delimiter

***Not present with Default SAP (0)**

Data Unit

See tables in descriptions of each SAP on following pages.

Figure 7. PROFIBUS SD2 telegram for Default SAP (0) and SAP 58-62

Default SAP (SAP 0) (Data_Exchange)

Allows the master to send output data to a slave station and to simultaneously request input data from the same station.

Outp_Data (Output Data)

DU length: 4 to 28 bytes (depending on the selected PPO message/
Standard telegram type)

Inp_Data (Input Data)

DU length: 4 to 28 bytes (depending on the selected PPO message/
Standard telegram type)

In addition to Default SAP, any master can read the I/O data of any slave at any time using the “Read_Inputs” (SAP 56) and “Read_Outputs” (SAP 57) telegrams (see Figure 7 on page 73). These telegrams have otherwise the same structure as the cyclic Data_Exchange telegram, but include the DSAP and SSAP bytes. In these telegrams, the MSB of the DA and SA bytes will be set to 1 to indicate that a DSAP/SSAP byte follows in the telegram header.

SAP 58 (Global_Control)

This SAP is used to send special commands addressed to a single slave, a special group of slaves, or all slaves at once (broadcast).

Global_Control Type: Octet String - Length: 2	
DU Byte	Description
0	<p>GC_Command</p> <p>MSB 0 0 x x x x x 0 LSB</p> <ul style="list-style-type: none"> Reserved Clear Data 0 = Do not clear output 1 = Clear output Unfreeze } 00 = No function } 10 = Activated } x1 = Deactivated Freeze } 00 = No function } 10 = Activated } x1 = Deactivated Un_Sync } 00 = No function } 10 = Activated } x1 = Deactivated Sync } 00 = No function } 10 = Activated } x1 = Deactivated Reserved
1	<p>Group_Select</p> <p>0 to 255. The value must match the Group Identification number of SAP 61 (DU Byte 6).</p>

8	<p>DPV1_Status_2 (DP-V1 only) (Not supported)</p> <p>MSB x x x x x x 0 x LSB</p> <ul style="list-style-type: none"> — Chk_Cfg_Mode 0 = Chk_Cfg according to EN 50170 (default state) 1 = User-specific evaluation of Chk_Cfg — Reserved. To be parameterised with '0'. — Enable_Update_Alarm 0 = Enable_Update_Alarm disabled 1 = Enable_Update_Alarm enabled — Enable_Status_Alarm 0 = Enable_Status_Alarm disabled 1 = Enable_Status_Alarm enabled — Enable_Manufacturer_Specific_Alarm 0 = Enable_Manufacturer_Specific_Alarm disabled 1 = Enable_Manufacturer_Specific_Alarm enabled — Enable_Diagnostic_Alarm 0 = Enable_Diagnostic_Alarm disabled 1 = Enable_Diagnostic_Alarm enabled — Enable_Process_Alarm 0 = Enable_Process_Alarm disabled 1 = Enable_Process_Alarm enabled — Enable_Pull_Plug_Alarm 0 = Enable_Pull_Plug_Alarm disabled 1 = Enable_Pull_Plug_Alarm enabled
9	<p>DPV1_Status_3 (DP-V1 only)</p> <p>MSB 0 0 0 x 1 x x x LSB</p> <ul style="list-style-type: none"> — Alarm_Mode. Not supported. Limits the number of active alarms. 0 = 1 alarm of each type 1 = 2 alarms in total 2 = 4 alarms in total 3 = 8 alarms in total 4 = 12 alarms in total 5 = 16 alarms in total 6 = 24 alarms in total 7 = 32 alarms in total — Prm_Structure 0 = Prm telegram according to EN 50170 1 = Prm telegram in structure form (DPV2 extension) — IsoM_Req (Isochron Mode Request). Not supported. 0 = Isochron Mode disabled 1 = Isochron Mode enabled — Reserved. To be parameterised with '0'.

10	1Bh (Default)	Structured_Length Length of the structured Prm telegram. (User parameter length is 23 bytes + 4 header bytes.)
11	81h	Structure_Type 129: USER_PRM_DATA
12	0	Slot_Number Set to 0.
13	0	Reserved.
User_Prm_Data (Parameter Data Extended) Type: Octet String - Length: 23		
14	00h (default)	<p>Header byte</p> <p>MSB 0 0 0 0 0 x 0 x LSB</p> <p>Fail-safe mode. Defines the action taken when the PLC is switched from 'RUN' to 'STOP' mode. 00 = STOP (default) 01 = LAST REFERENCE 02 = USE FAIL-SAFE. The values of the PZDs are defined by bytes 11-30 in the Prm_Data telegram.</p> <p>Control zero mode. Defines the action taken if a PROFIBUS telegram containing only zeros is received. 00 = USE FRAME (default). Note that, with this setting, the drive might not be stopped (if it is running) since also bit 10 (Remote Command) in the control word is zero. However, the other PZD's may still be updated, but have the value zero. 01 = IGNORE</p> <p>Reserved</p>
15 - 16	0-65536	Cut off time out in milliseconds. 0 = Cut off disabled.
17 - 18	0-65536	Fail-safe, PZD1 (typically CW)
19 - 20	0-65536	Fail-safe, PZD2 (typically REF)
21 - 22	0-65536	Fail-safe, PZD3
23 - 24	0-65536	Fail-safe, PZD4
25 - 26	0-65536	Fail-safe, PZD5
27 - 28	0-65536	Fail-safe, PZD6
29 - 30	0-65536	Fail-safe, PZD7

31 - 32	0-65536	Fail-safe, PZD8
33 - 34	0-65536	Fail-safe, PZD9
35 - 36	0-65536	Fail-safe, PZD10

The extended Parameter Data bytes are configured via the PROFIBUS network configuration tool. The functions are defined in the GSD file.

SAP 62 (Chk_Cfg)

With this telegram, the master will send the selected data exchange (Write_Read_Data) telegram type code to slave SAP 62. The table below gives the typical hexadecimal values (DU Byte 0...n) that are sent to the drive in order to select the PPO type or standard telegram (ST).

Telegram name	Cyclical telegram length (in words)	Default code for message type (see figure below)	Supported parameter channel access mode
PPO 1	4 PKW + 2 PZD in/out	F3 F1	DP-V0 / DP-V1*
PPO 2	4 PKW + 6 PZD in/out	F3 F5	DP-V0 / DP-V1*
PPO 3	0 PKW + 2 PZD in/out	F1	DP-V1*
PPO4	0 PKW + 6 PZD in/out	F5	DP-V1*
PPO 5	4 PKW + 10 PZD in/out	F3 F9	DP-V0 / DP-V1*
PPO 6	0 PKW + 10 PZD in/out	F9	DP-V1*
ST 1	2 PZD in / 2 PZD out	C3 C1 C1 FD 00 01	DP-V1
ST 2	4 PZD in / 4 PZD out	C3 C3 C3 FD 00 02	DP-V1

*DP-V1 mode selected by the user.

PKW: "Parameter-Kennung-Wert" (Parameter ID value)

PZD: "Prozeßdaten" (Process data, cyclically transferred)

The default codes for the PPO types in the table above defines data consistency over the message as follows:

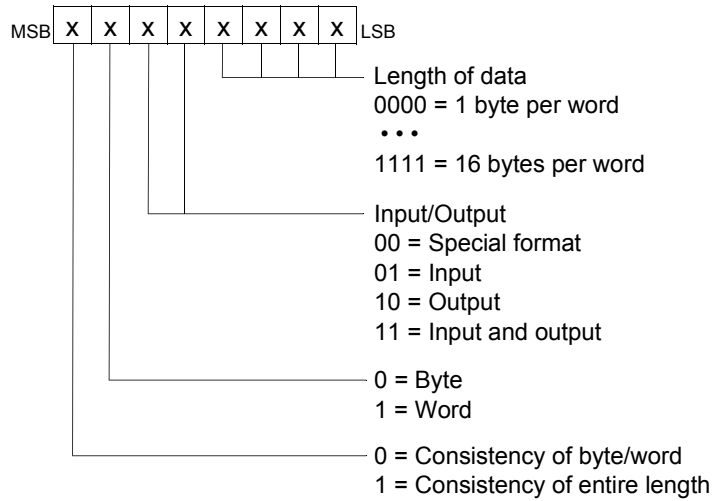

For example, 11110001 = F1 = PPO3

Also data non-consistent over the entire message is supported by the FPBA-01. The cyclical frame types supported by the module are defined in the GSD file.

SAP 60 (Slave_Diag)

This SAP gives diagnostic information on the slave station.

<p>Diag_Data (Diagnostic Data) Type: Octet String - Length: 6 (Standard) + 2 (Extended Diagnosis) (DP-V0 mode) + 5 (Extended Diagnosis) (DP-V1 mode) Note: During initialisation, the module only sends the standard part of the message.</p>	
DU Byte	Description
0	<p>Station_Status_1</p> <ul style="list-style-type: none"> Diag.Station_Non_Existent (Set by Master, reset by Slave) Slave not found Diag.Station_Not_Ready (Set by Slave) Slave not ready for data exchange Diag.Cfg_Fault (Set by Slave) Received configuration data does not match original config. data Diag.Ext_Diag (Set by Slave) Diagnostic entry present in slave-specific diagnostic area Diag.Not_Supported (Set by Slave) Service not supported by slave Diag.Invalid_Slave_Response (Set by Master, reset by Slave) Invalid response by slave Diag.Prm_Fault (Set by Slave) Invalid parameter or parameter value Diag.Master_Lock (Set by Master, reset by Slave) Slave is parameterised by another master

1	<p>Station_Status_2</p> <p>MSB x 0 x x x 1 x x LSB</p> <ul style="list-style-type: none"> Diag.Prm_Req (Set by Slave) Slave requires re-configuration and re-parameterisation Diag.Stat_Diag (Set by Slave) Static diagnosis. Slave (temporarily) unable to provide valid data Always set to 1 by slave Diag.WD_On (Set by Slave) Watchdog on Diag.Freeze_Mode (Set by Slave) Freeze command received by slave Diag.Sync_Mode (Set by Slave) Sync command received by slave Reserved Diag.Deactivated (Set by Master, reset by Slave) Slave is inactive
2	<p>Station_Status_3</p> <p>MSB x 0 0 0 0 0 0 0 LSB</p> <ul style="list-style-type: none"> Reserved Diag.Ext_Diag_Overflow (Set by Slave)
3	<p>Diag.Master_Add The address of the master that parameterised this slave</p>
4 - 5	<p>Ident_Number (for FPBA-01: 0959h)</p>
6**	<p>Ext_Diag_Data (0x02) (DP-V0 only) The number of bytes (including this byte) reserved for Extended Diagnosis</p>
6*	<p>Header Byte (DP-V1 only) The complete header consists of 5 bytes with the FPBA-01.</p> <p>MSB 0 0 x x x x x x LSB</p> <ul style="list-style-type: none"> Block length in bytes including header Diagnostic type 00 = Device-related diagnostic according to PROFIdrive 3.1.

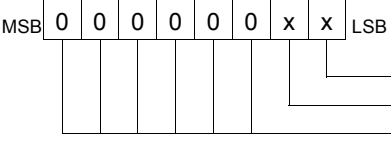
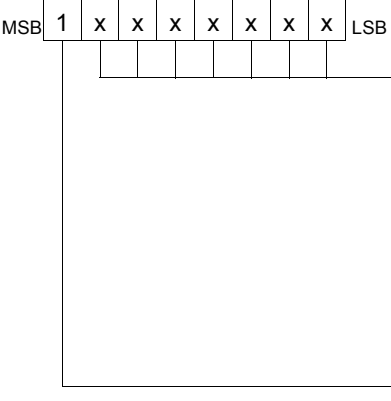
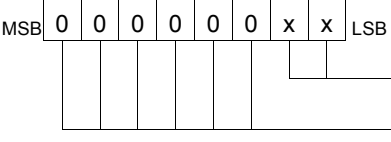
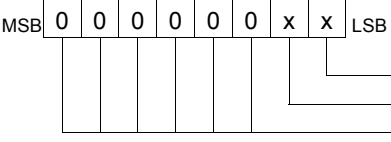
7**	<p>Communication Diagnostic (DP-V0 only)</p>  <p>MSB 0 0 0 0 0 0 x x LSB</p> <p>Communication temporarily lost Communication permanently lost Reserved</p>
7*	<p>Status Type = Status Message (0x81) (DP-V1 only)</p>  <p>MSB 1 x x x x x x x LSB</p> <p>Diagnostic type 0 = Reserved 1 = Status_Message (normal alarm message) 2 = Module_Status 3 = DXB_Link_Status 4 to 29 = Reserved 30 = PrmCmdAck 31 = Red_State 32 to 126 = Manufacturer-specific 127 = Reserved</p> <p>Set to 1</p>
8*	<p>Slot Number (0x00) (DP-V1 only) Slot number (0 to 244).</p>
9*	<p>Specifier (0x00) (DP-V1 only)</p>  <p>MSB 0 0 0 0 0 0 x x LSB</p> <p>Specifier Reserved</p>
10*	<p>Communication Diagnostic (DP-V1 only)</p>  <p>MSB 0 0 0 0 0 0 x x LSB</p> <p>Communication temporarily lost Communication permanently lost Reserved</p>

*The FPBA-01 is operated in DP-V1 mode. The Diagnostics information is according to PROFIdrive 3.1.

**The FPBA-01 is operated in DP-V0 (DP) mode. The Diagnostics information is according to PROFIdrive 2.0.

Other SAPs for DP-V1 communication

Master Class	Master SAP	Slave SAP	Short Name	Meaning
C1	51	51	Server SAP	Read, Write, Alarm
C1	51	50	Alarm SAP	Alarm
C2	50	49	Resource Mgmt. SAP	Req PDU
C2	50	48..0	Communication SAP	Abort, Read/Write, Data_Transfer
C2	62	55	Set_Slave_Add	Change Station Address (C2 Master)

Cyclical message types

PPO types

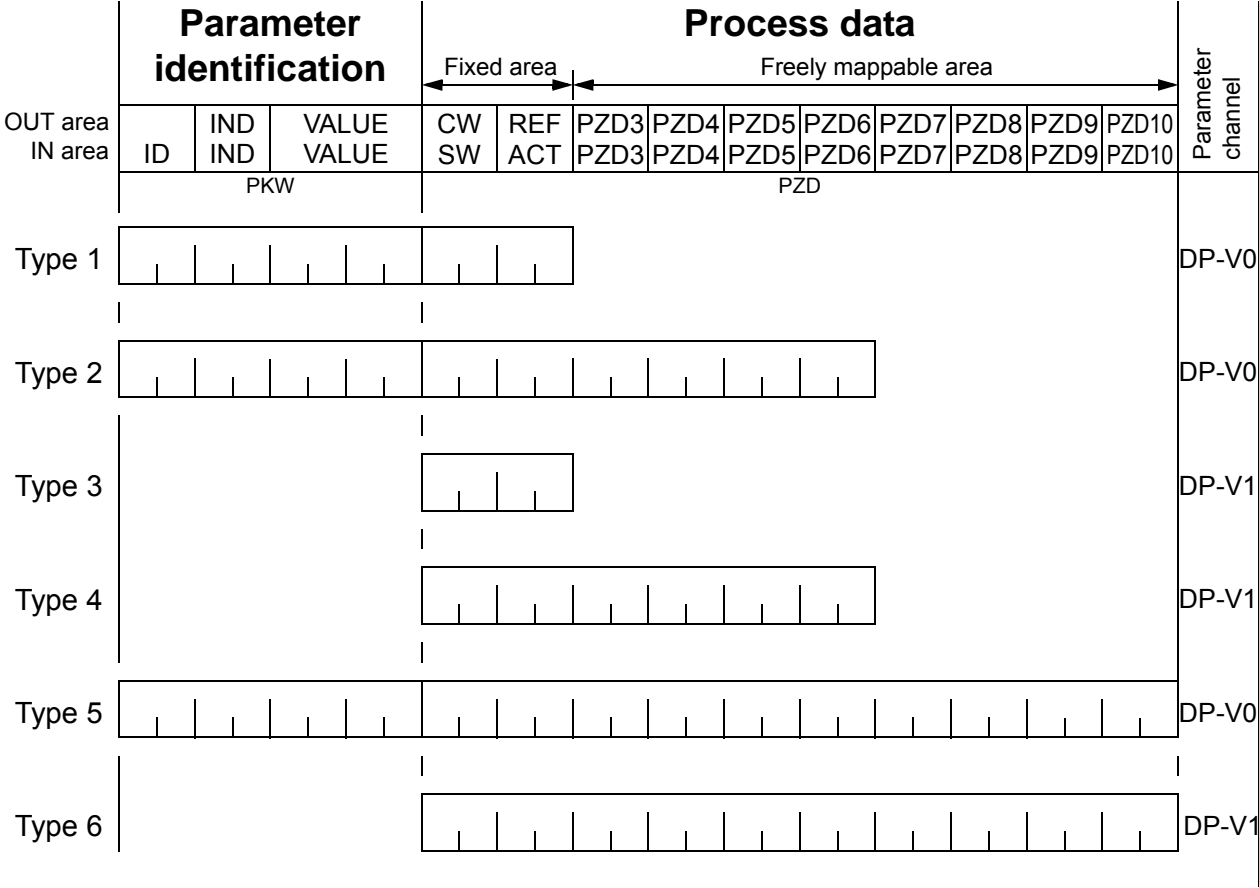

OUT area – Data sent from Master to Slave (control data)

IN area – Data sent from Slave to Master (actual data)

Parameter Identification:

- ID – Parameter Identification
- IND – Index for Arrays
- VALUE – Parameter Value (Max. 4 bytes)
- PKW – Parameter ID/Value

Process Data:

- CW – Control Word
- SW – Status Word
- REF – Reference
- ACT – Actual Value
- PZD – Process Data (application-specific)
- DW – Data Word

Figure 8. PPO message types

Standard telegram (ST) types

ST1		PZD1	PZD2
OUT area	STW1 Control word 1	NSOLL_A Speed setpoint A	
IN area	ZSW1 Status word 1	NIST_A Speed actual value A	

ST2		PZD1	PZD2...3	PZD4
OUT area	STW1 Control word 1	NSOLL_B Speed setpoint B	STW2 Control word 2	
IN area	ZSW1 Status word 1	NIST_B Speed actual value B	ZSW2 Status word 2	

Figure 9. Standard telegram types (DP-V1)

Note: For the contents of the Control Word, the Status Word, References, and Actual Values, see the chapter [Communication profiles](#).

Parameter handling in cyclic communication (DP)

In cyclic PROFIBUS DP communication, parameter data is transferred in PPO message types 1, 2 and 5 (see [Figure 8.](#)). The Parameter Identification part consists of eight bytes (see below).

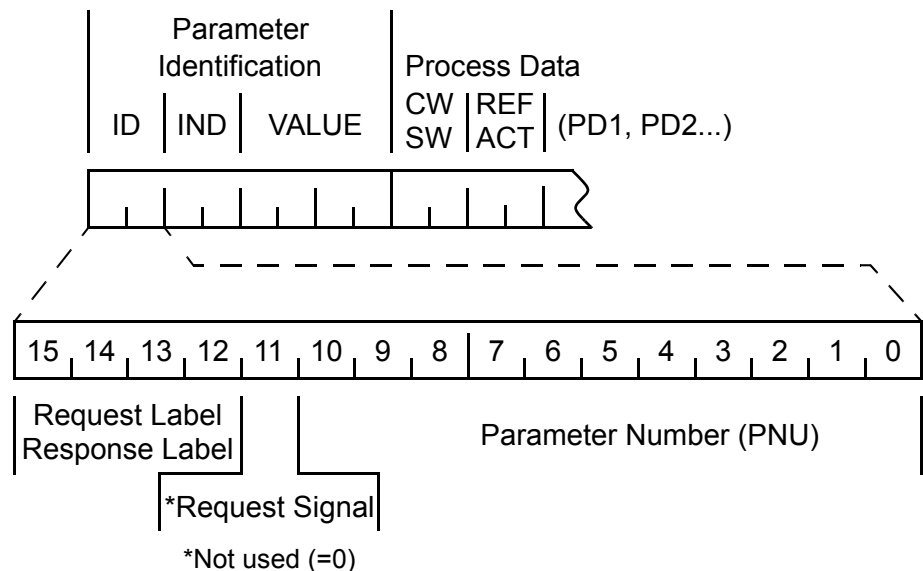

The Request Label is used by the master when transmitting data to the slave, while the Response Label is used by the slave as a positive or negative acknowledgement. The tables below show the Request/Response functions.

Request labels (from Master to Slave)		Response labels	
Request	Function	Ackn. (+)	Ackn. (-)
0	No task	0	–
1	Request parameter value	1, 2	7
2	Change parameter value (word)	1	7, 8
3	Change parameter value (double word)	2	7, 8
4	Request description element	3	7
5	Change description element	3	7, 8
6	Request parameter value (array)	4, 5	7, 8
7	Change parameter value (array word)	4	7, 8
8	Change parameter value (array double word)	5	7,8
9	Request number of array elements	6	7

Response label (Acknowledgement from Slave to Master)	
Ackn.	Function
0	No response
1	Transfer parameter value (word)
2	Transfer parameter value (double word)
3	Transfer description element
4	Transfer parameter value (array word)
5	Transfer parameter value (array double word)
6	Transfer number of array elements
7	<p>Task cannot be executed, followed by error number</p> <ul style="list-style-type: none"> 0 = Illegal parameter number 1 = Parameter value cannot be changed 2 = Lower or upper limit violated 3 = Erroneous subindex 4 = No array 5 = Incorrect data type 6 = Setting not allowed (can only be reset) 7 = Descriptive element cannot be changed 9 = Descriptive data not available 11 = No parameter change rights 15 = Text array not available 17 = Task cannot be executed due to operating status (e.g. parameter is currently read-only) 18 = Other error 101 = Vendor specific error 102 = Request not supported 103 = Request cannot be completed due to communication error 110 = Failure during write to non-volatile memory 111 = Request aborted due to time-out 120 = Parameter cannot be mapped to PZD (size mismatch or non-existent) 121 = Parameter cannot be mapped to PZD (end of memory) 122 = Parameter cannot be mapped to PZD (multiple PZD write) 130 = Cannot map Control Word bit (parameter 933 - 937, e.g. double mapping of bits) 140 = Cannot change mode to TORQUE (frequency is used) 150 = Internal buffer overflow 160 = Internal communication error
8	No parameter change rights for PKW interface
9	Parameter data signal (word)
10	Parameter data signal (double word)

The allocation of drive control/actual words, drive parameters and PROFIdrive parameters to the Parameter Identification part of the PPO type is shown below. The **Index** column corresponds to the parameter number (PNU) in the ID part of Parameter Identification. The **Sub-index** column corresponds to the IND part of Parameter Identification. The **Example No.** column refers to the examples on the following pages.

Virtual drive control area					
Index	Sub-index	Par. No. (Decimal)	Request Label		Example No.
0h	1h	1	R/W	6/7/8*	1, 2
0h	2h	2			
...					
0h	63h	99			

*Supported with an ACSM1 drive only

Drive parameters					
Index	Sub-index	Par. No. (Decimal)	Request Label		Example No.
1	1	101	R/W	6/7/8*	1, 2
1	2	102			
...					
63h	63h	9999			

*Supported with an ACSM1 drive only

PROFIdrive parameters						
Index	Sub-index	Par. No. (Decimal)		Request Label		Example No.
393h	2h	915	2	R/W	6/7	6
	3h		3			
			
	9h		9			
394h	2h	916	2	R/W	6/7	7
	3h		3			
			
	9h		9			
396h	0h	918		R/W	1/2	3, 4
...						
3B3h	0h	947	1	R	6	5
	9h		9			
	11h		17			
	19h		25			
	21h		33			
	29h		41			
...						
3CCh	0h	972		R/W	1/2	3,4

The complete PROFIdrive parameter list for the FPBA-01 can be found as a separate chapter elsewhere in this manual.

Note: Continuous (cyclic) writing of PROFIdrive parameters should be avoided as the values of these parameters are stored in the flash memory of the FPBA-01. The estimated lifetime of the flash memory is 100,000 program/erase cycles, and continuous writing will cause the memory to fail prematurely.

Parameter data transfer examples

Note: Only the 'Data unit' part of the telegram is presented in the examples. See Figure 7 on page 73.

Example 1: Reading a drive parameter (or data set)

To determine the parameter number and subindex for drive parameter reading, convert the drive parameter group number and the parameter index number to hexadecimal. The index number is the subindex (IND), and the group number is the parameter number (PNU). For example, to read parameter 84.11 from the drive:

84.11 = 54h.0Bh => Parameter Number = 54h, Subindex = 0Bh.

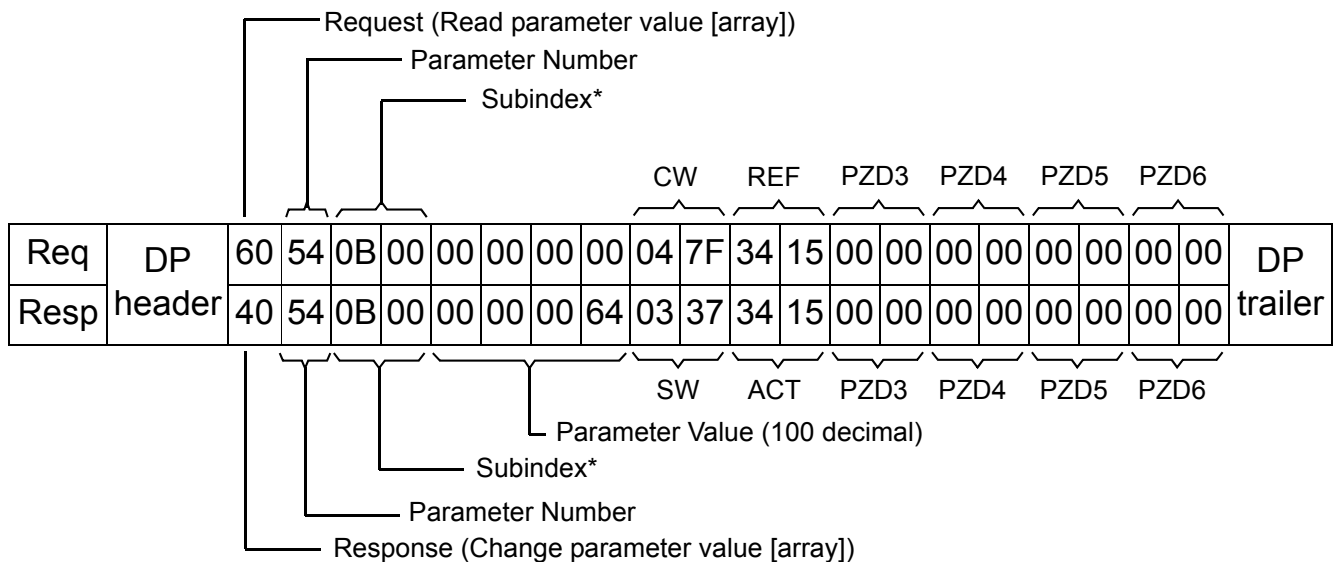

*2nd byte reserved

Error response:

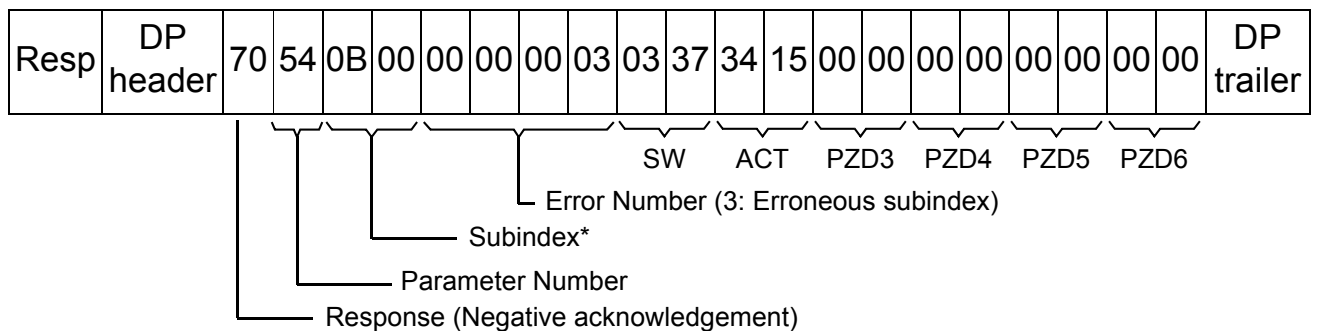

*2nd byte reserved

Example 2: Writing a drive parameter (or data set)

To determine the parameter number and subindex for drive parameter writing, convert the drive parameter group number and the parameter index number to hexadecimal. The index number is the subindex (IND), and the group number is the parameter number (PNU). For example, to write parameter 12.02 to the drive: 12.02 = 0Ch.02h => Parameter number = 0Ch, Subindex = 02h

The following is an example of writing a 16-bit parameter.

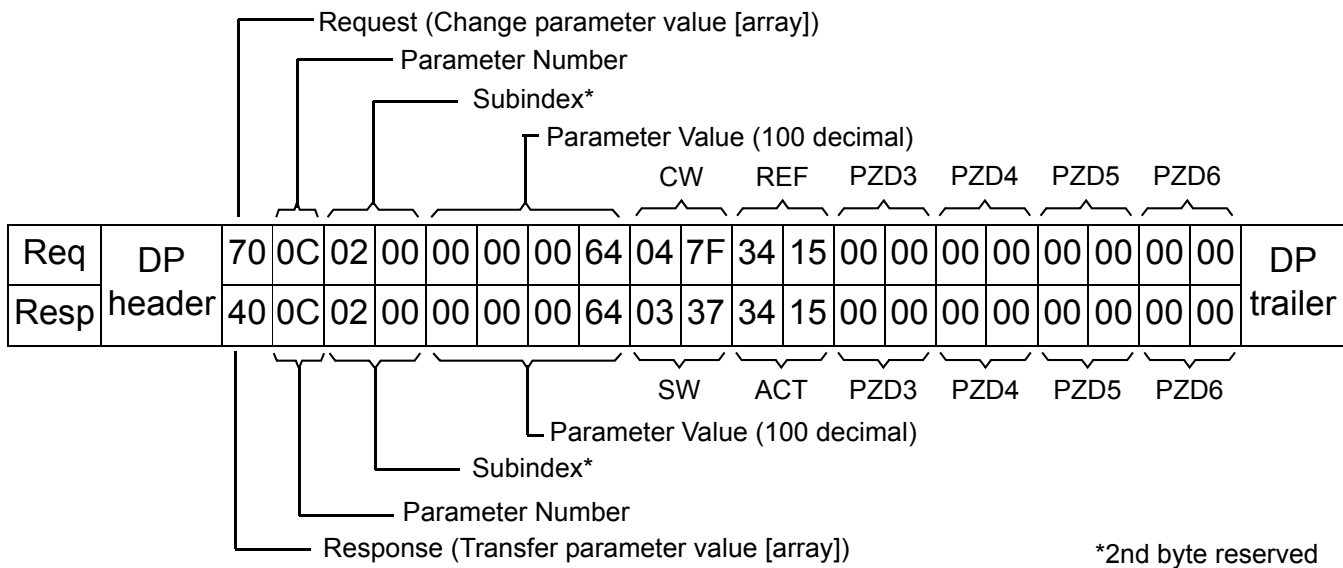

This is an example of writing a 32-bit parameter:

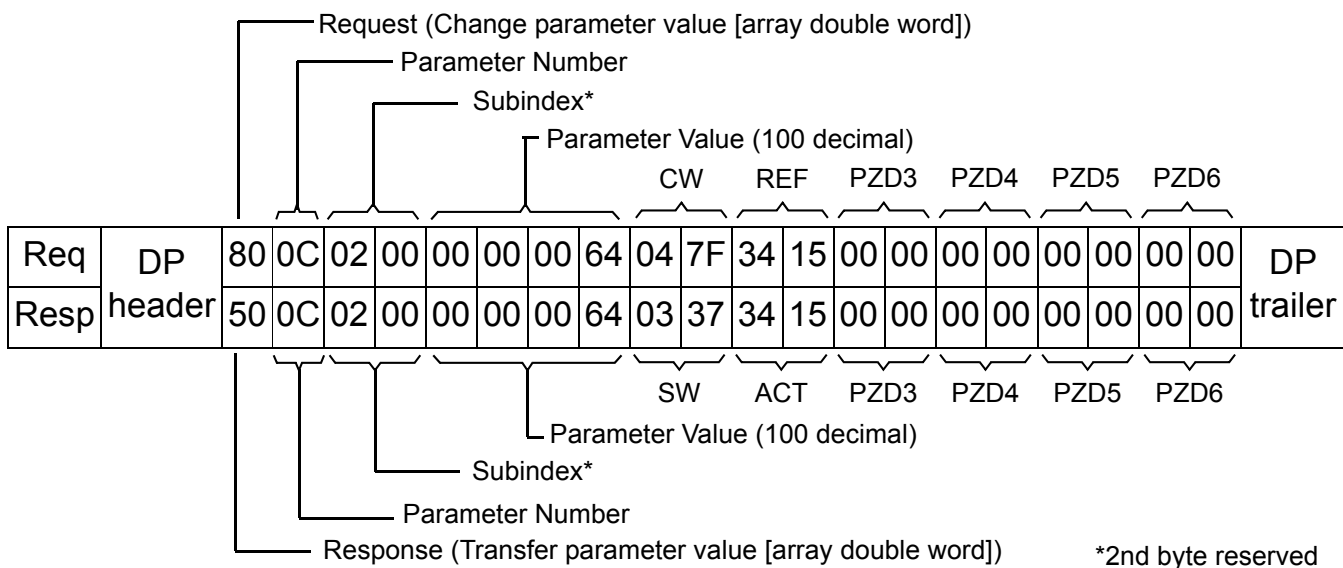

Example 3: Reading a PROFIdrive parameter (word)

In this example, PROFIBUS Parameter 918 is used to read the station number of the slave.

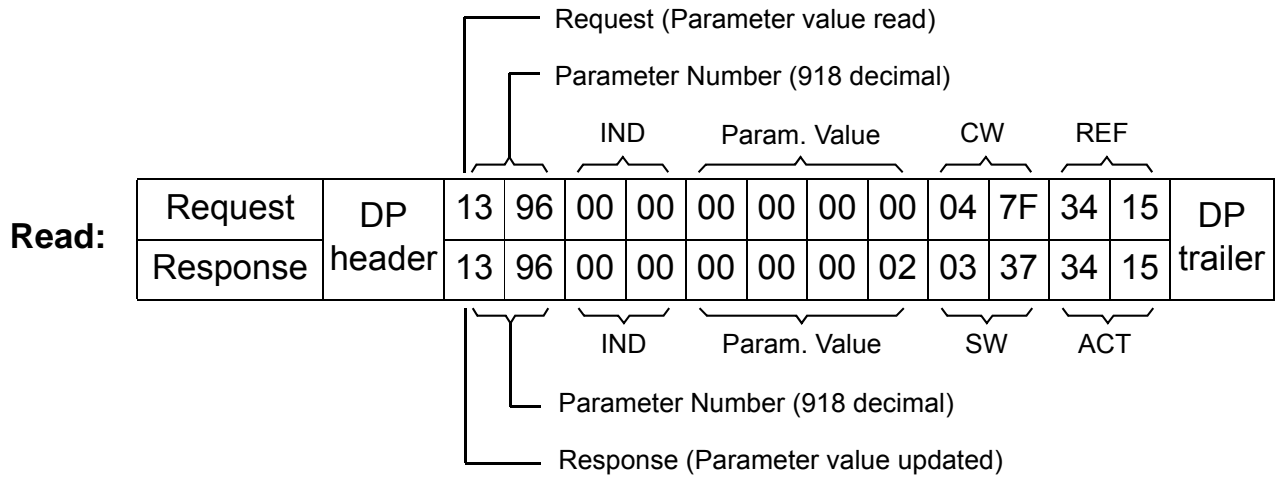

The slave returns its station number (2).

Example 4: Writing a PROFIdrive parameter (word)

In this example, current parameter settings are saved to the FLASH memory of the drive. This is done by setting the value of PROFIBUS Parameter 971 (3CBh) to 1.

Note that the drive always observes the Control Word (CW) and Reference (REF) bytes. The values shown below are examples.

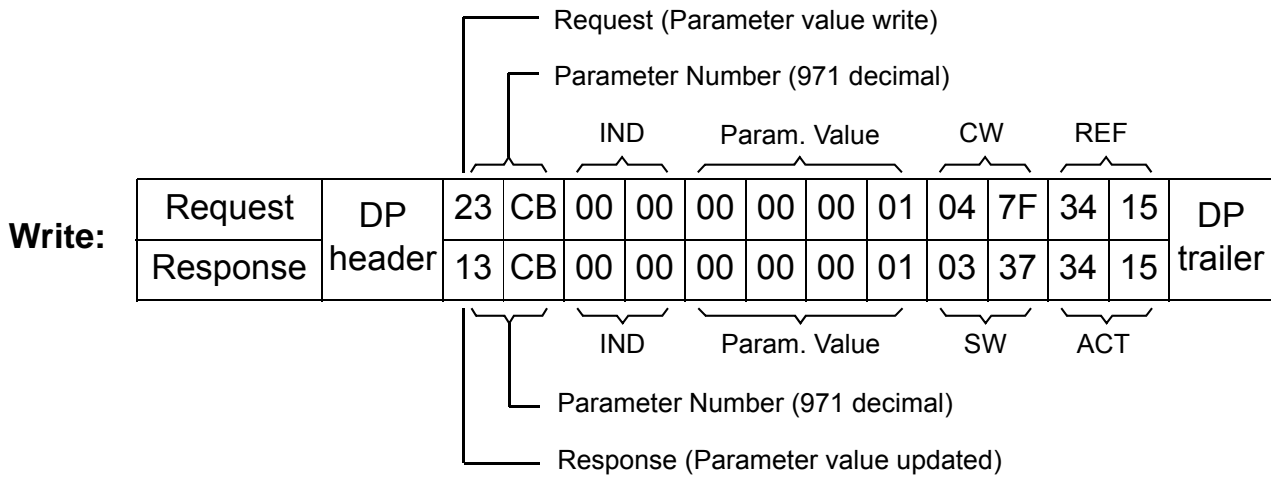

Example 5: Reading a PROFIdrive parameter (array)

In this example, PROFIBUS Parameter 947 is used to read the code of the latest acknowledged fault. As shown on page 125, parameter 945 is of the array type with subindexes 1, 9, 17 and 25.

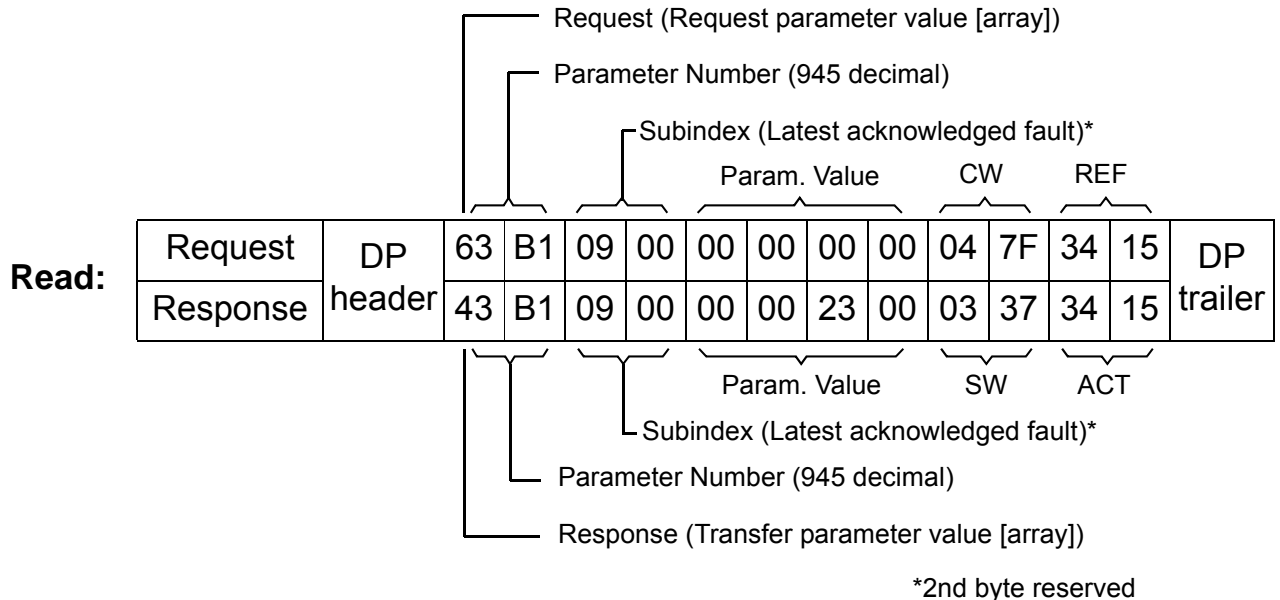

The slave returns the code of the latest acknowledged fault (2300h). The fault codes are according to the DRIVECOM® standard. See also the User's Manual of the drive for drive-specific fault codes.

The implementation of the PROFIdrive profile in the FPBA-01 supports the storage of the active and the five latest occurred different faults in the fault buffer. The fault codes can be accessed by PROFIdrive parameters 945, 947 and 948 (see page 123). The value zero indicates no fault. The subindexes of these parameters are related to each other, i.e. parameter 945 with subindex 1 relates to subindex of parameter 947 and 948.

Example 6: Configuring the process data written to the drive

PROFIBUS parameter 915 can be used to define which data is written cyclically to a drive parameter as application-specific process data.

In the example below, the value of drive parameter 12.02 (0Ch.02h) is selected to be taken from PZD3. The parameter will continue to be updated with the contents of PZD3 in each Request frame until a different selection is made.

Subindex (IND) defines which process data word (PZD) the required data is taken from. *Parameter Value* selects the drive parameter to which that word is mapped.

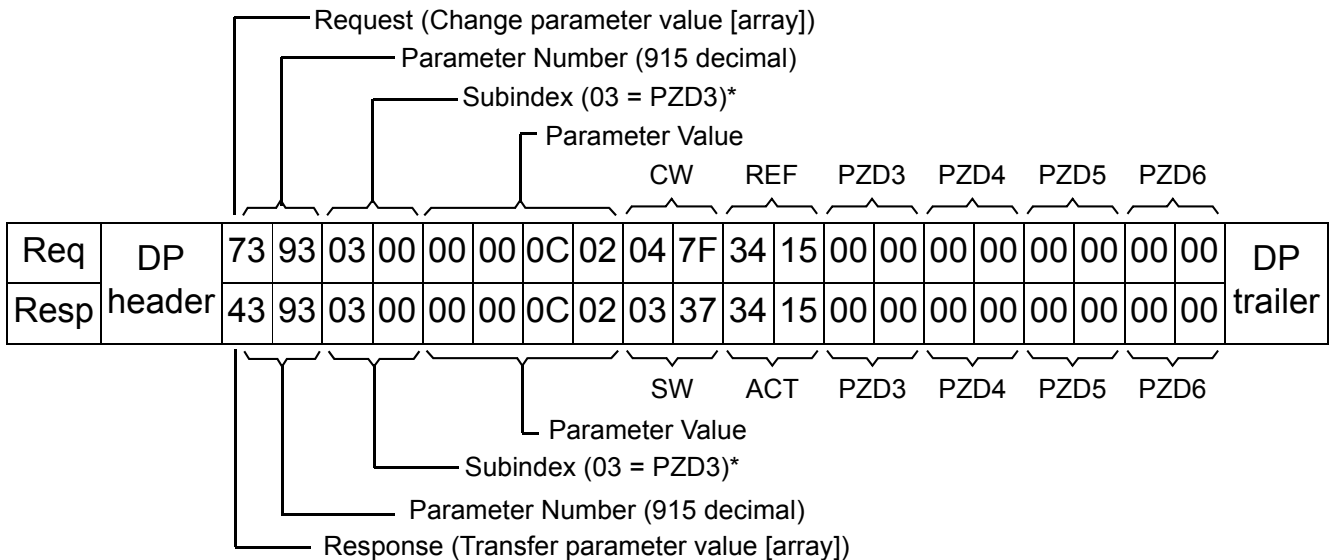

*2nd byte reserved

Subsequently, the contents of PZD3 in each Request frame are written to drive parameter 12.02 CONSTANT SPEED 1 until a different selection is made.

DP-V1 read/write request sequence

A read/write service on a drive parameter is illustrated below.

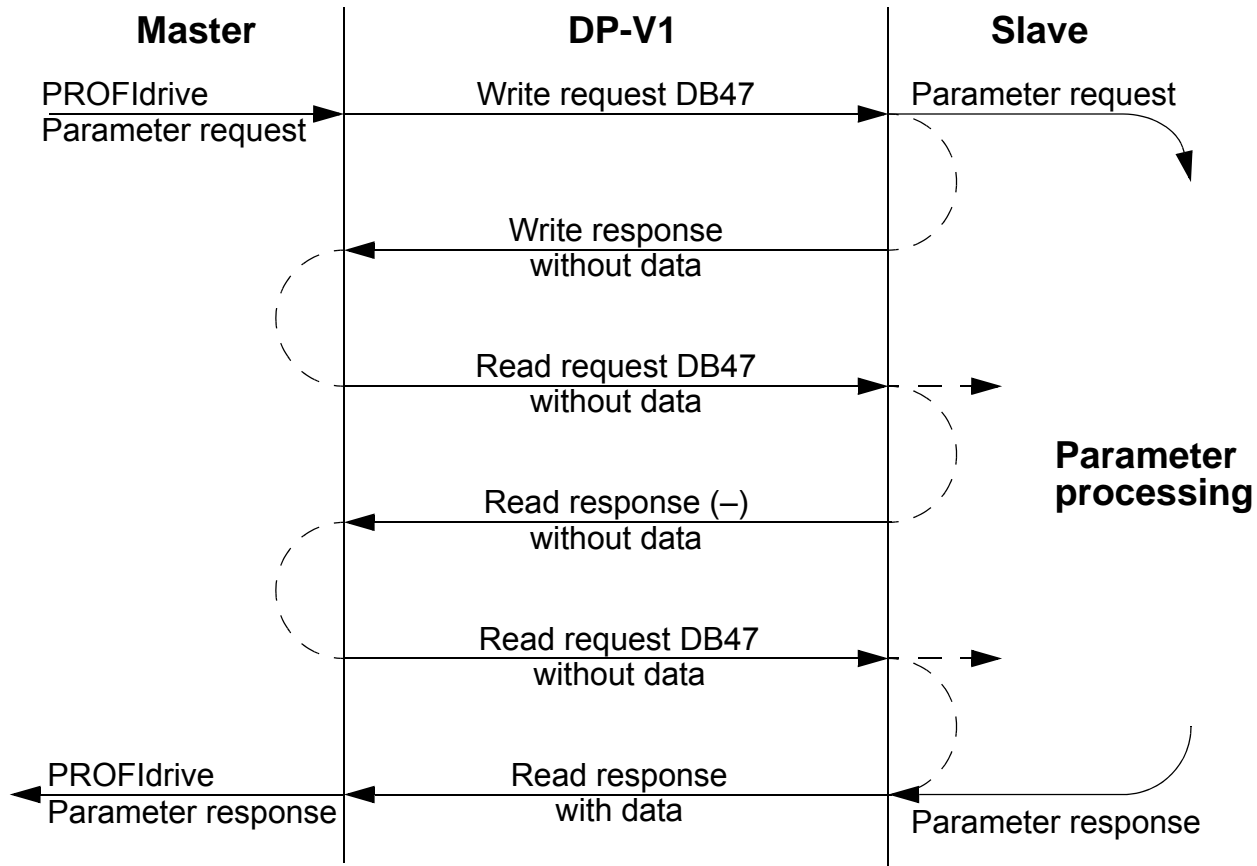

The messaging employs DP-V1 data units. The PROFIdrive parameter request is contained within the DP-V1 request as data. Likewise, the DP-V1 response contains the PROFIdrive parameter response as data.

A write request (Function number 5Fh – see Table 8 below) is first sent containing the parameter request.

If the write request is valid, the FPBA-01 acknowledges it with DP-V1 write response code 5Fh with no data. The master will then send a read request. If the FPBA-01 is still busy performing the internal parameter request, it will return a negative response with the DP-V1 error code B5h (State conflict). In this case, the read

request will be repeated by the master until the FPBA-01 has the PROFIdrive response data ready.

If the write request is invalid, a negative response is returned with a DP-V1 error code (see Table 10).

PROFIBUS SD2 telegram for SAP 51

The Read/Write service uses a variable-length PROFIBUS SD2 telegram shown below.

DP header									DP trailer		
SD	LE	LEr	SD	DA	SA	FC	DSAP	SSAP	DU	FCS	ED
68h	x	x	68h	xx	xx	x	xx	xx	x...	xx	16h

SD = Start Delimiter
 LE = Length
 LEr = Length repeated
 DA = Destination Address
 SA = Source Address
 FC = Function Code
 DSAP = Destination Service Access Point
 SSAP = Source Service Access Point
 DU = Data Unit for DP services
 FCS = Frame Checking Sequence
 ED = End Delimiter

Data unit					
DP-V1 Command/Response				PROFIdrive V3 Parameter Channel	
DU0	DU1	DU2	DU3	Request/Response header (see Table 11/12 below)	Data

Byte	Meaning	Value
DU0	Function number	See Table 8 below
DU1	Slot number	0 = Module itself 1 = Drive parameter access
DU2	Index	47 (0x2F)
DU3	Data length	(Depends on type of message)
DU4...DU _n	PROFIdrive data	

Figure 10. PROFIBUS SD2 telegram for SAP 51

Table 8. DP-V1 function numbers

Value	Meaning
0x48	Idle REQ, RES
0x51	Data transport REQ, RES
0x56	Resource manager REQ
0x57	Initiate REQ, RES
0x58	Abort REQ
0x5C	Alarm REQ, RES
0x5E	Read REQ, RES
0x5F	Write REQ, RES
0xD1	Data transport negative response
0xD7	Initiate negative response
0xDC	Alarm negative response
0xDE	Read negative response
0xDF	Write negative response

Table 9. DP-V1 error response

Byte	Meaning and value
DU0	Function number = 0xDF (Error Write) = 0xDE (Error Read)
DU1	Error_Decode: PROFIdrive: Always 0x80 (DP-V1 codes)
DU2	Error_Code_1: Error class/error code (see Table 10 below)
DU3	Error_Code_2: Always 0

Table 10. DP-V1 error response: Error codes

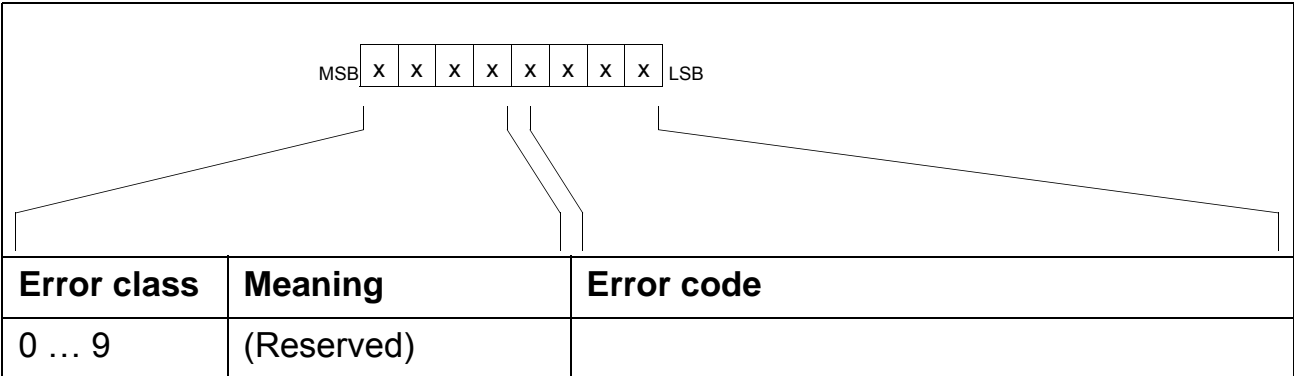

10 (0x0A)	Application	0 = Read error 1 = Write error 2 = Module failure 3 ... 7 = Reserved 8 = Version conflict 9 = Feature not supported 10 ... 15 = User-specific
11 (0x0B)	Access	0 = Invalid index 1 = Write length error 2 = Invalid slot 3 = Type conflict 4 = Invalid area 5 = State conflict 6 = Access denied 7 = Invalid range 8 = Invalid parameter 9 = Invalid type 10 ... 15 = User-specific
12 (0x0C)	Resource	0 = Read constraint conflict 1 = Write constraint conflict 2 = Resource busy 3 = Resource unavailable 4 ... 7 = Reserved 8 ... 15 = User-specific
13 ... 15	User-specific	

Table 11. PROFIdrive Request header

Field(s)	Description	Range	Byte/ Word
Request Reference	Unique identification set by the master. Changed for each new request.	1 ... 255	Byte
Request ID	Request type for the issued block.	Request Parameter (01h) Change Parameter (02h)	Byte

Drive Object ID	To be set to 0 or 1.	0 ... 255	Byte
No. of Parameters	Number of parameters that are present in the request.	1 ... 37	Byte
Attribute	Type of object being accessed. Note: "Description" and "Text" are not supported.	Value (10h) Description (20h) Text (30h)	Byte
No. of Elements	Number of array elements accessed or length of string accessed. Set to 0 if non-array parameters are used.	0, 1 ... 234	Byte
Parameter Index	Address of the parameter that is being accessed. "0" is allowed by FPBA-01.	1 ... 65535	Word
Subindex	Addresses the first array element of the parameter or the beginning of a string access or the text array, or the description element that is being accessed.	0 ... 65535	Word
Format*	See Table 13.	See Table 13	Byte
Number of Values*	Number of values following.	0 ... 234	Byte
Values*	The values of the request. In case of odd number of bytes, a zero byte is appended to ensure the word structure of the telegram.	–	See Format field
*Only if Request ID is 02h (Change Parameter). The Format, Number of Values and Values fields are repeated for other parameters.			

Table 12. PROFIdrive Response header

Field(s)	Description	Range
Response Reference	Mirrored from the request.	1 ... 255
Response ID	Response from the slave. In case any requested services fail, a "not acknowledged" (NAK) response will be indicated.	Request Param OK (01h) Request Param NAK (81h) Change Param OK (02h) Change Param NAK (82h)

Drive Object ID	To be set to 1.	0 ... 255
No. of Parameters	Number of parameters that are present in the response.	1 ... 37
Format*	See Table 13.	See Table 13
Number of Values*	Number of values following.	0 ... 234
Values*	The values of the request. In case of odd number of bytes, a zero byte is appended to ensure the word structure of the telegram.	–
*Only if Response ID is 01h (Request Parameter OK). The Format, Number of Values and Values fields are repeated for other parameters.		

Table 13. Data types for Format field

Code	Type
0x00	(Reserved)
0x01 ... 0x36	Standard data types 1 Boolean (not supported) 2 Integer8 (not supported) 3 Integer16 4 Integer32 5 Unsigned8 (not supported) 6 Unsigned16 7 Unsigned32 8 Floating point (not supported) 9 Visible string (not supported) ...
0x37 ... 0x3F	(Reserved)
0x40	Zero
0x41	Byte
0x42	Word
0x43	Double word

0x44	Error
0x45 ... 0xFF	(Reserved)

Table 14. PROFdrive Parameter Request error codes

Error #	Meaning	Used at
00h	Impermissible parameter number	Access to unavailable parameter
01h	Parameter value cannot be changed	Change access to a parameter value that cannot be changed
02h	Low or high limit exceeded	Change access with value outside the limits
03h	Invalid subindex	Access to unavailable subindex
04h	No array	Access with subindex to non-indexed parameter
05h	Incorrect data type	Change access with value that does not match the data type of the parameter
06h	Setting not permitted (can only be reset)	Change access with value unequal to 0 when this is not permitted
07h	Description element cannot be changed	Change access to a description element that cannot be changed
09h	No description data available	Access to unavailable description (parameter value is available)
0Bh	No operation priority	Change access rights without rights to change parameters
0Fh	No text array available	Access to text array that is not available (parameter value is available)
11h	Request cannot be executed because of operating mode	Access is temporarily not possible for reasons that are not specified in detail
14h	Value impermissible	Change access with a value that is within limits but is not permissible for other long-term reasons (parameter with defined single values)

15h	Response too long	The length of the current response exceeds the maximum transmittable length
16h	Parameter address impermissible	Illegal value or value that is not supported for the attribute, number of elements, parameter number or sub-index, or a combination
17h	Illegal format	Write request: Illegal format or format of parameter data that is not supported
18h	Number of values inconsistent	Write request: Number of values of parameter data does not match number of elements at the parameter address
65h ... FF	Manufacturer-specific error area	–
65h	Vendor-specific error	Vendor-specific error
66h	Request not supported	Request not supported
67h	Communication error	Request cannot be completed because of communication error
6Eh	Non-volatile error	Failure during write to non-volatile memory
6Fh	Time-out error	Request aborted because of timeout
78h	PZD map failure	Parameter cannot be mapped to PZD (size mismatch or non-existent)
79h	PZD memory failure	Parameter cannot be mapped to PZD (out of memory)
7Ah	Multiple PZD map	Parameter cannot be mapped to PZD (multiple PZD write)
82h	Control word bit map	Cannot map Control word bit (parameter 933...937, e.g. double mapping of bits)
8Ch	Set torque mode error	Cannot change mode to TORQUE (frequency is used)
90h	Illegal Request ID	The request ID of the response is illegal

Communication

96h	Internal buffer	Buffer overflow
A0h	Internal communication	Communication error between module and drive

Parameter data transfer examples

The following examples show how parameter data is transferred using the DP-V1 mechanisms READ and WRITE.

Note: Only the “Data unit” part of the SD2 telegram is presented in the examples. See Figure 10 on page 102.

Example 1a: Reading a drive parameter (array element)

Drive parameters are addressed so that the drive parameter group corresponds to the parameter index (PNU), and the drive parameter number within the group corresponds to the subindex (IND). In the following example, a value is read from drive parameter number 12.04 (0C.04h).

DP-V1 Write request (Read parameter value):

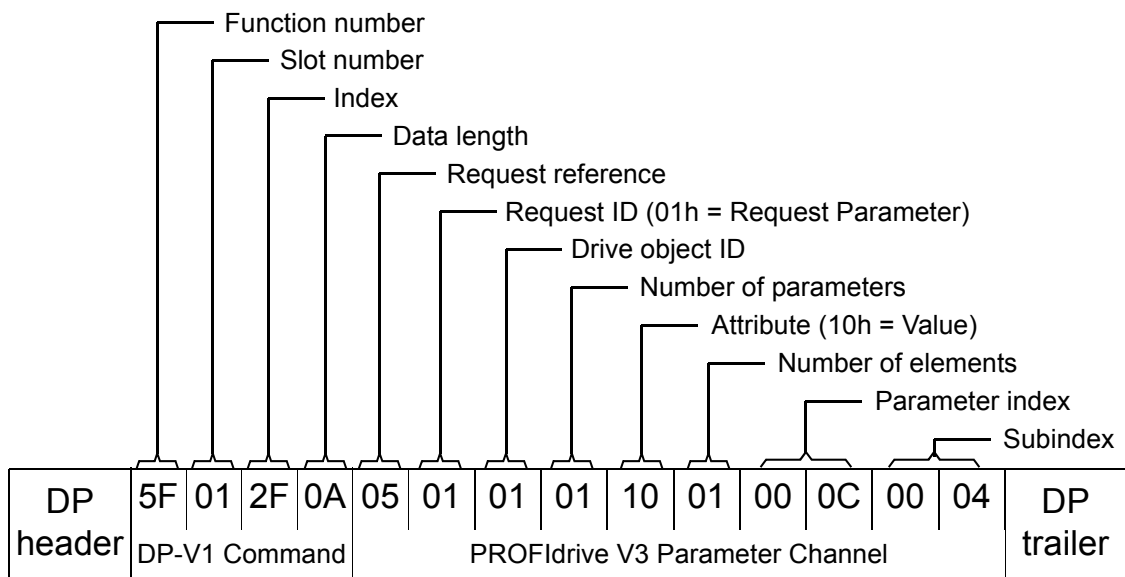

Positive Read response to DP-V1 Read request:

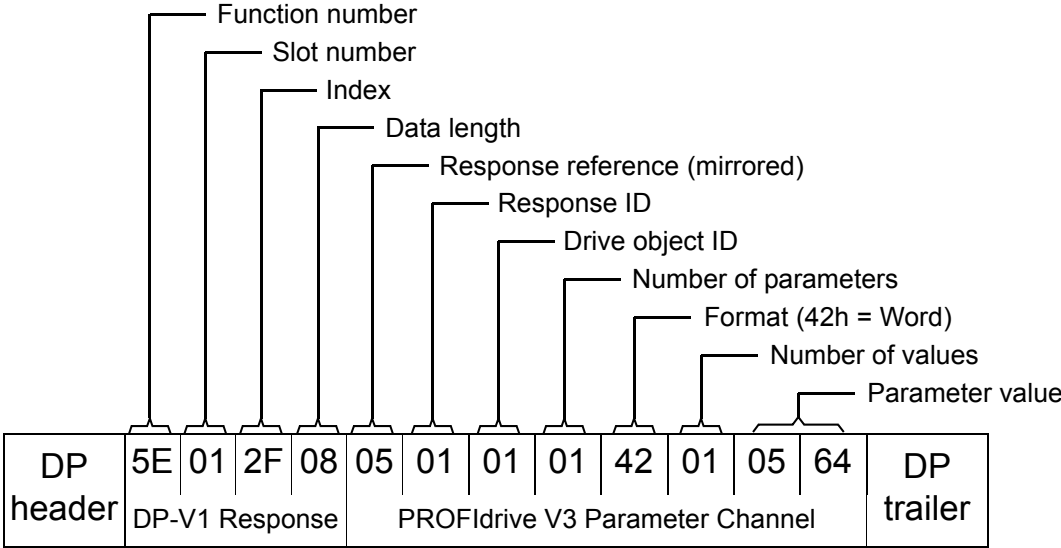

Negative response to PROFdrive Read request:

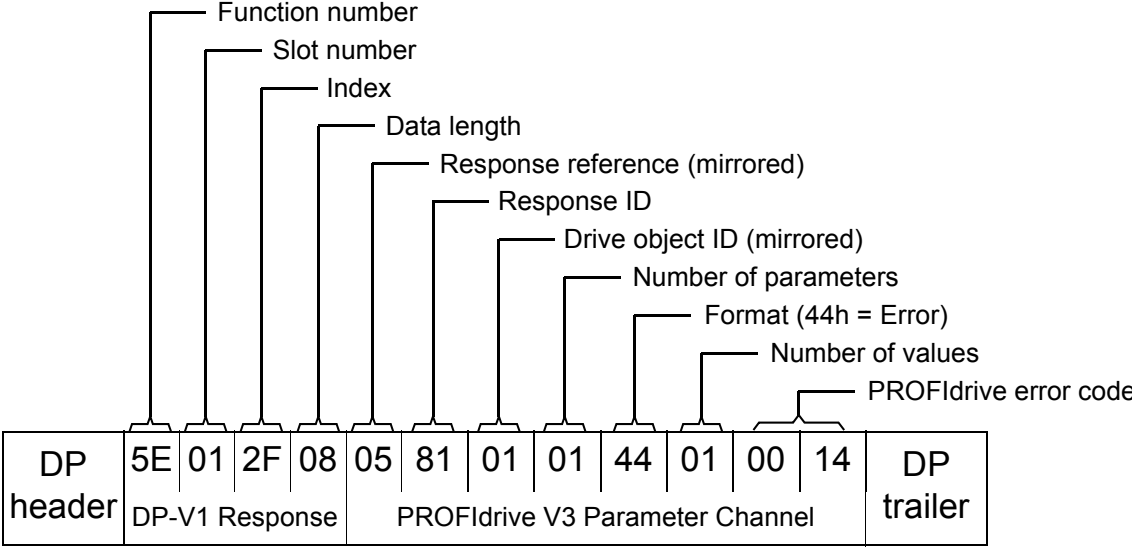

Positive Read response to DP-V1 Read request:

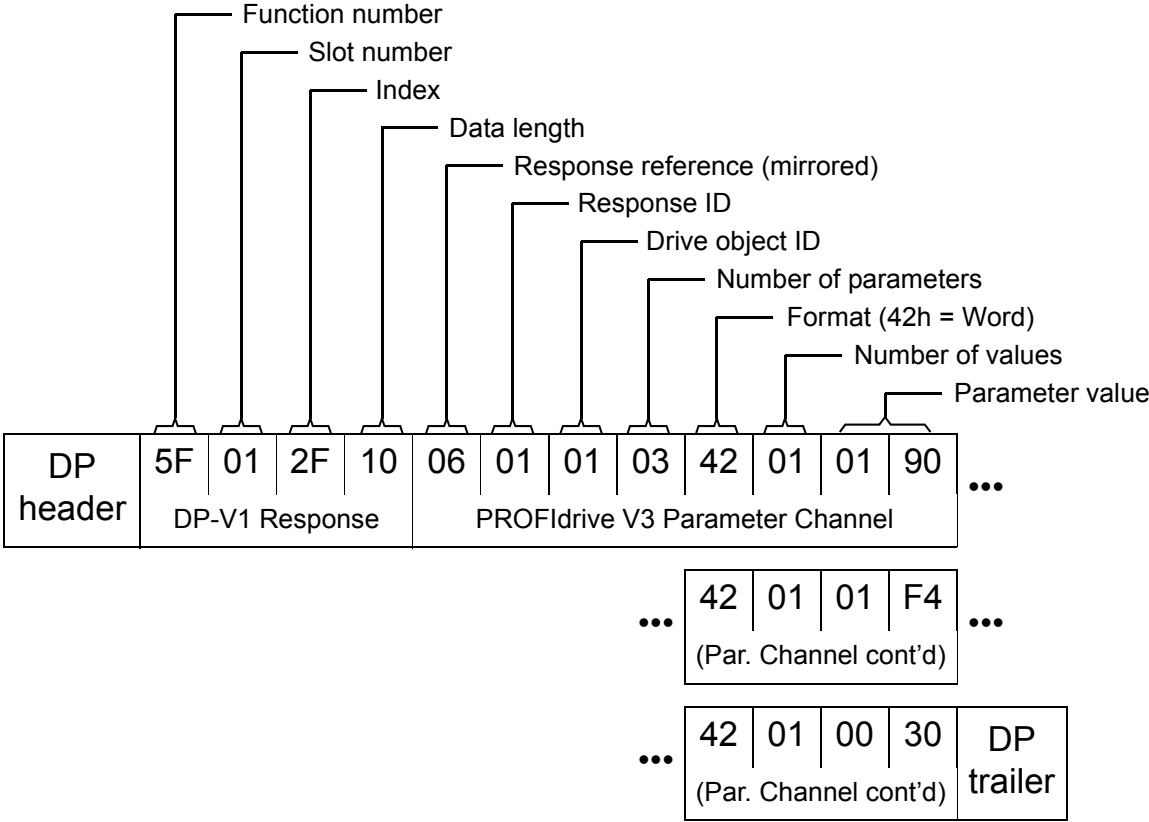

The values 190h (400), 1F4h (500) and 1Eh (30) are returned.

Example 2a: Writing a drive parameter (one array element)

Drive parameters are addressed so that the drive parameter group corresponds to the parameter index (PNU), and the drive parameter number within that group corresponds to the subindex (IND). In the following example, a value is written to drive parameter number 12.02 (0C.02h).

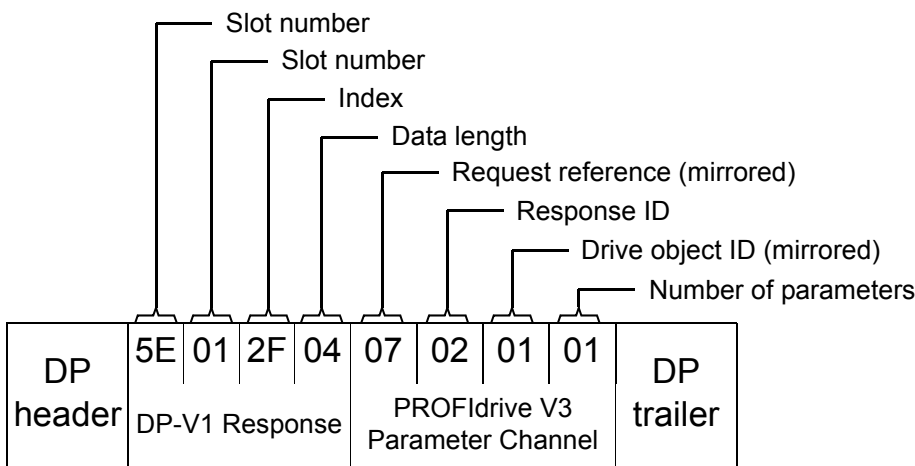
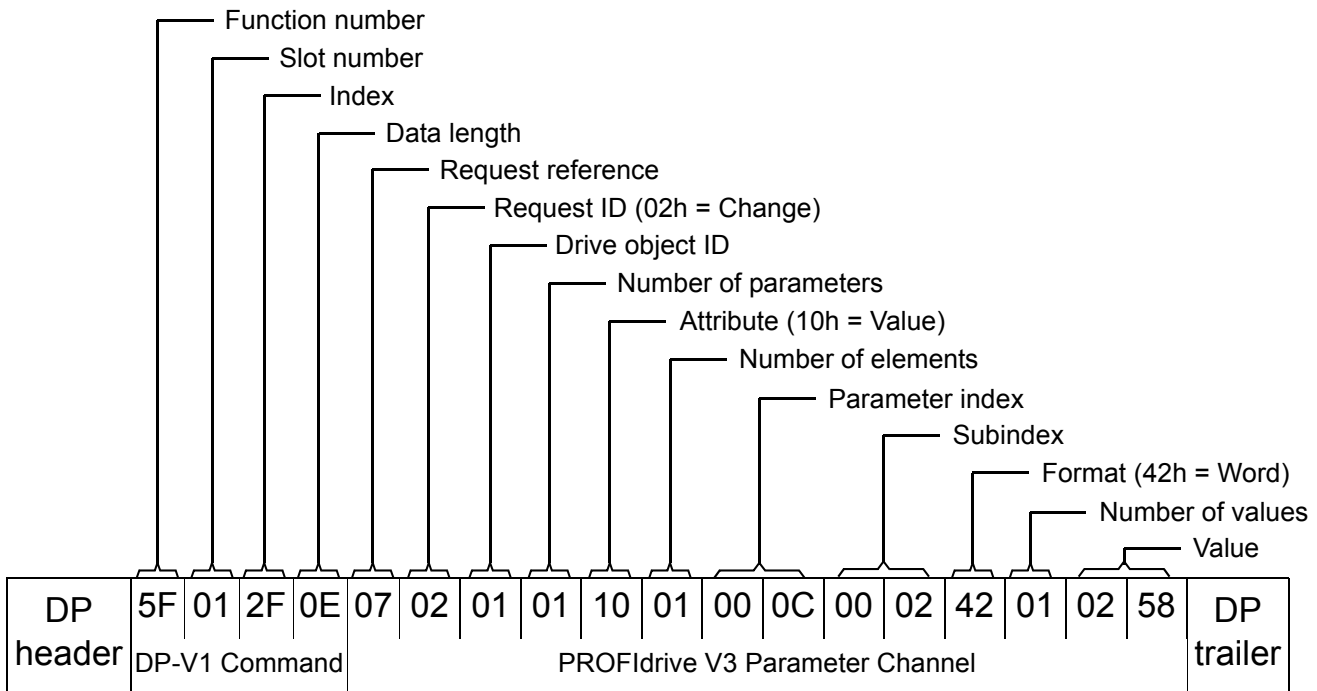

Example 2b: Writing 2 drive parameters (multi-parameter)

In this example, the values 300 (12Ch) and 500 (1F4h) are written to drive parameters 12.02 (0C.02h) and 20.08 (14.08h) respectively using one telegram.

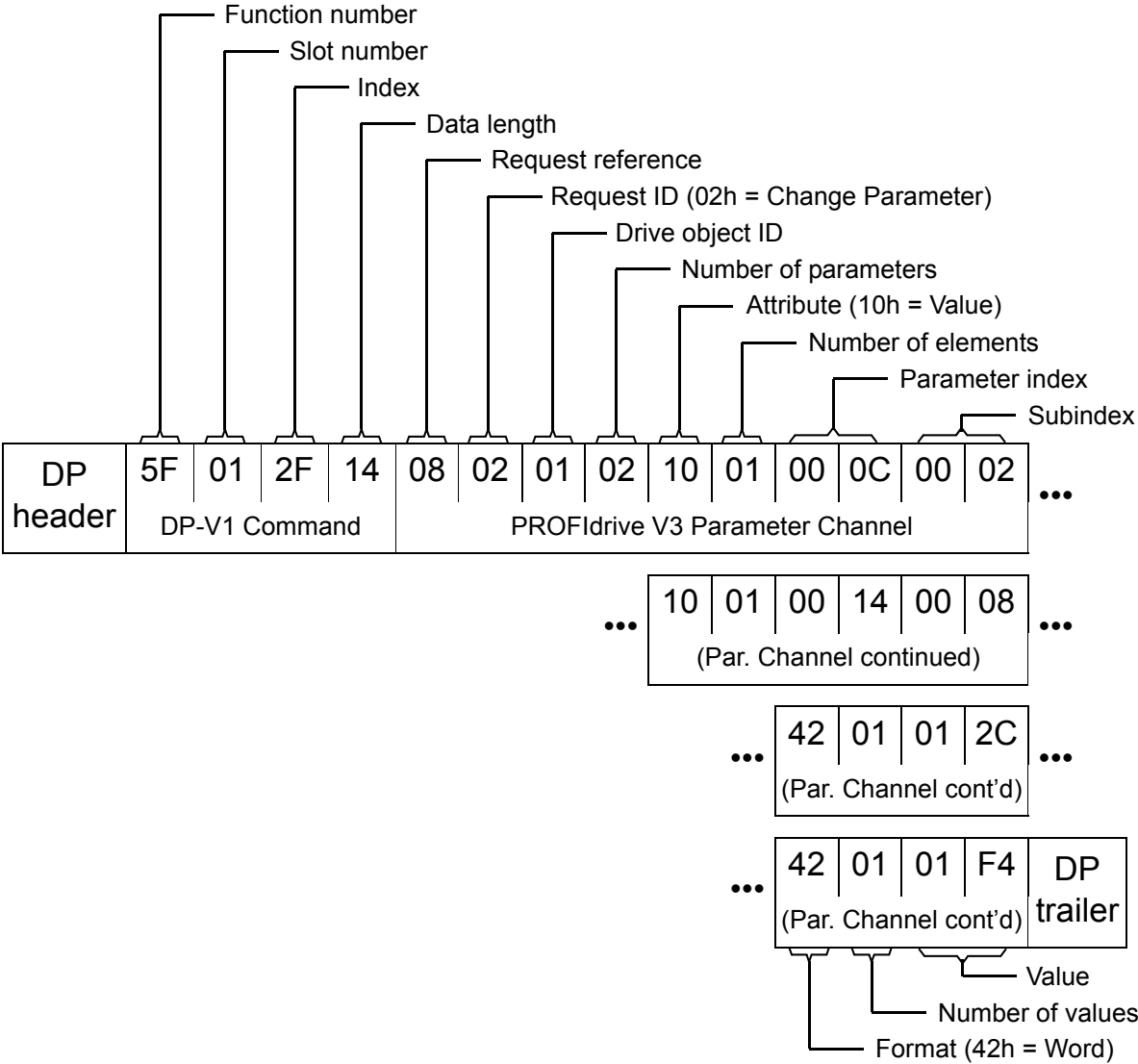

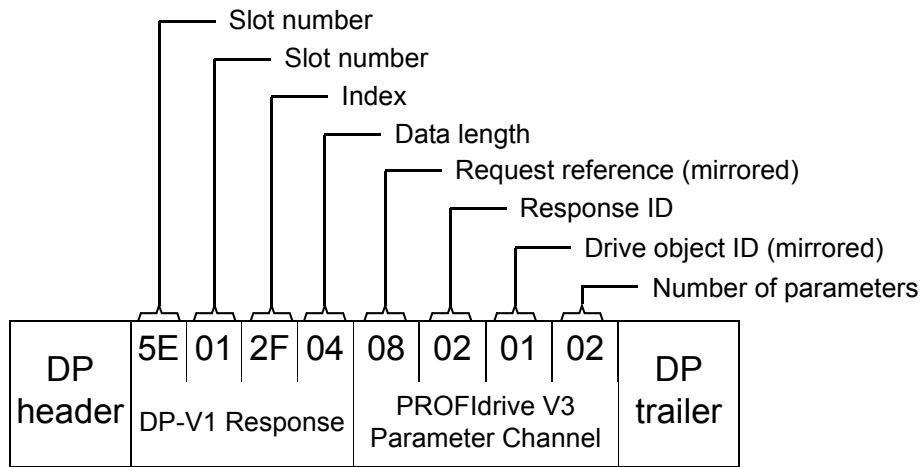

Example 3: Reading a PROFdrive parameter

In this example, PROFIBUS parameter No. 918 (396h) is used to read the station number of the slave.

DP-V1 Write request (Reading a PROFdrive parameter):

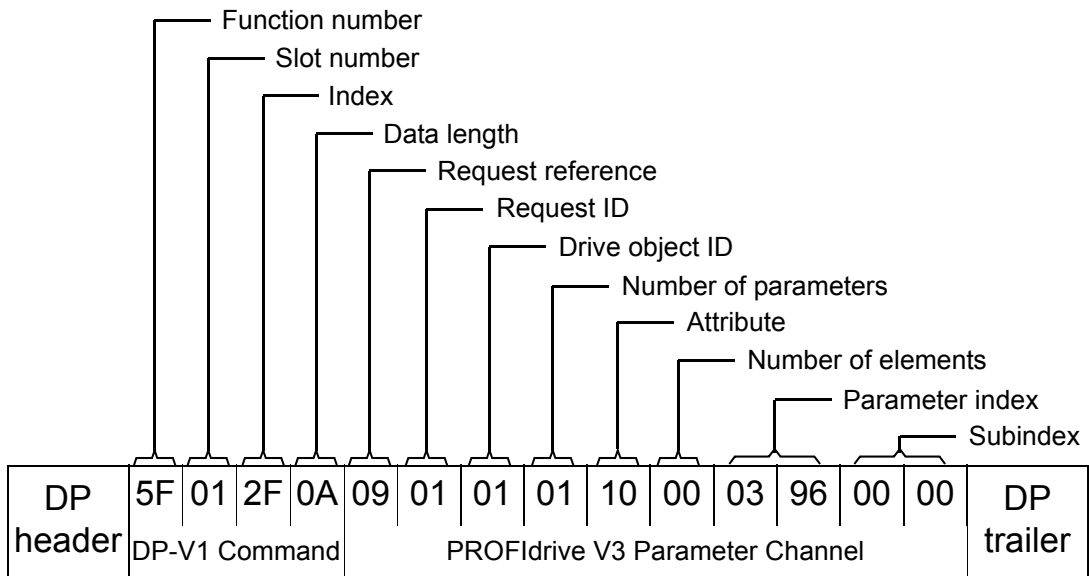

DP-V1 Read response

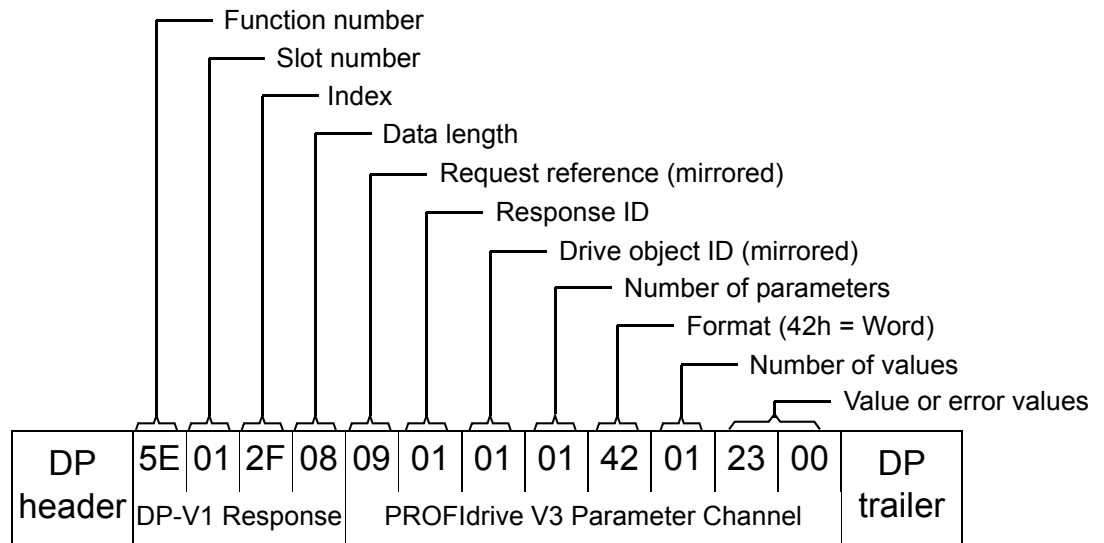

The slave returns the code of the latest acknowledged fault (2300h). The fault codes are according to the DRIVECOM standard. See also the User's Manual of the drive for drive specific fault codes.

The implementation of the PROFIdrive profile in the FPBA-01 supports the storage of the active and the five latest occurred different faults in the fault buffer. The fault codes can be accessed by PROFIdrive parameters 945, 947 and 948 (see page 123). The value zero indicates no fault. The subindexes of these parameters are related to each other, i.e. parameter 945 with subindex 1 relates to subindex of parameter 947 and 948.

Example 4: Configuring the process data written to the drive

PROFIBUS parameter No. 915 (393h) can be used to define which data is written cyclically to a drive parameter as application-specific process data.

In the example below, the value of drive parameter 12.06 (0C.06h) is selected to be taken from PZD3. The parameter will continue to be updated with the contents of PZD3 in each Request frame until a different selection is made.

Subindex (IND) defines which process data word the required data is taken from. *Value* selects the drive parameter to which that word is mapped.

DP-V1 Write request

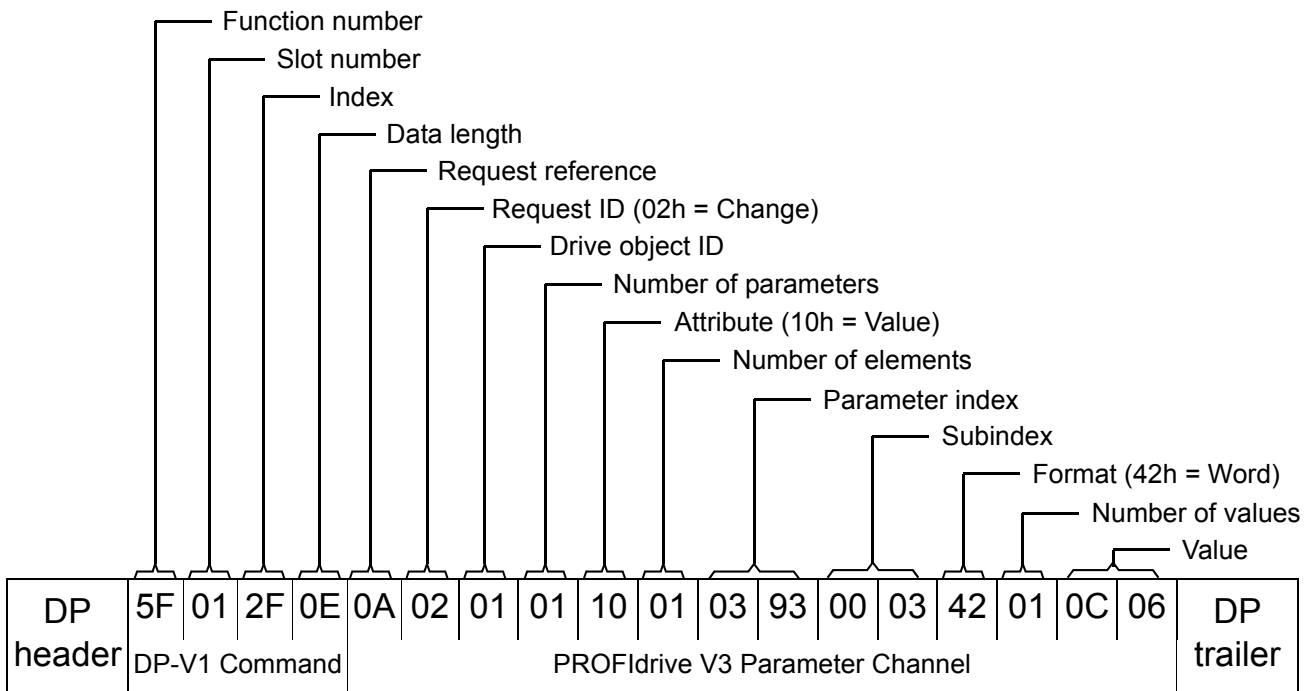

DP-V1 Read response

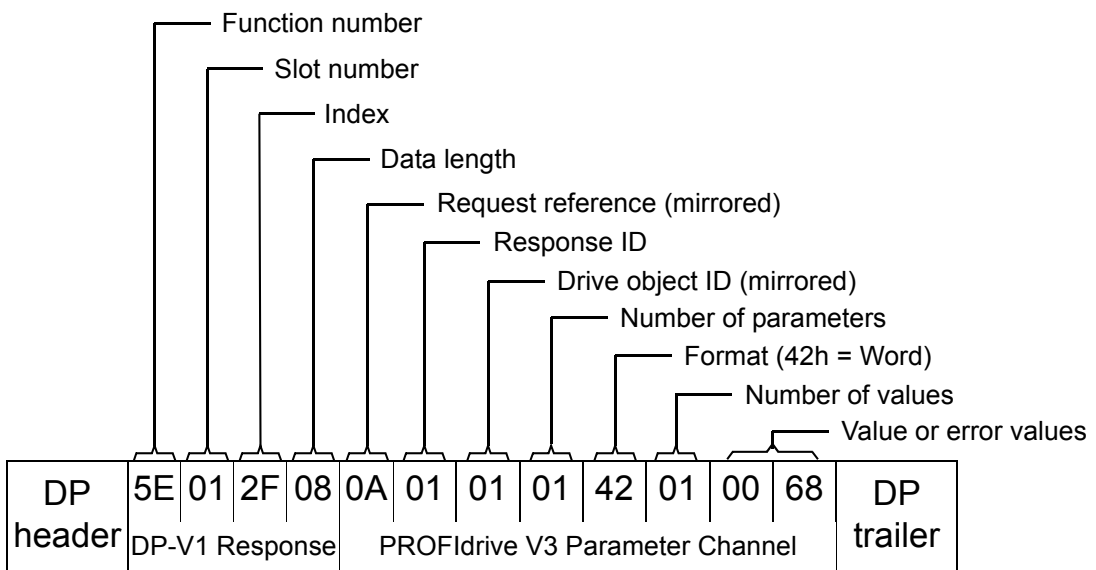

Subsequently, the contents of PZD3 in each Request frame are written to drive parameter 12.06 until a different selection is made.

Example 5: Determining the source of process data read from the drive

PROFIBUS Parameter No. 916 (394h) can be used to define which data is read cyclically from the drive as application-specific process data. In the example below, the parameter is used to determine which drive parameter the contents of PZD3 are taken from. *Subindex* (IND) defines which process data word the required data is transmitted in.

DP-V1 Write request

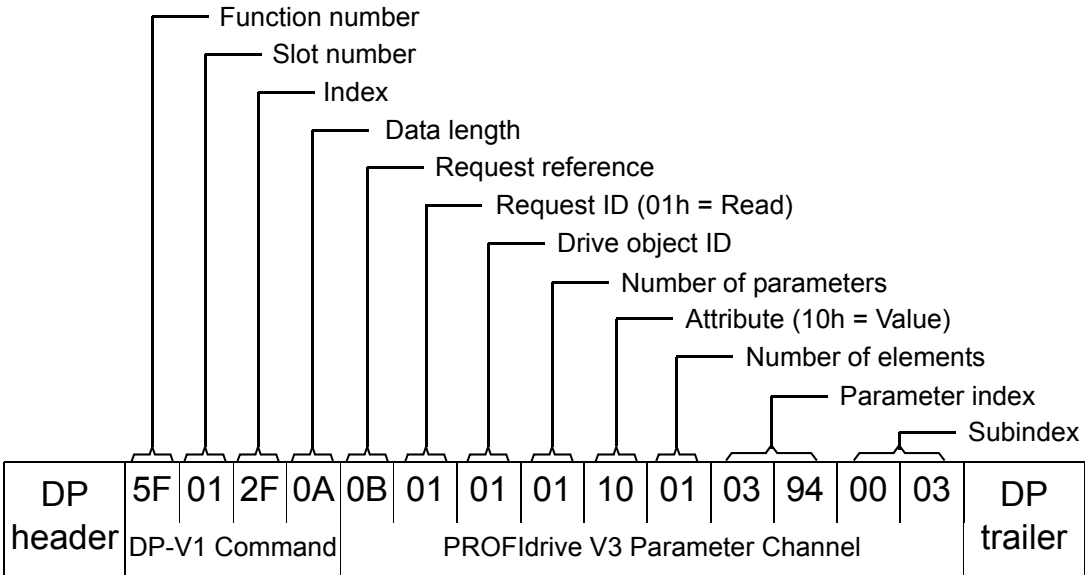

DP-V1 Read response

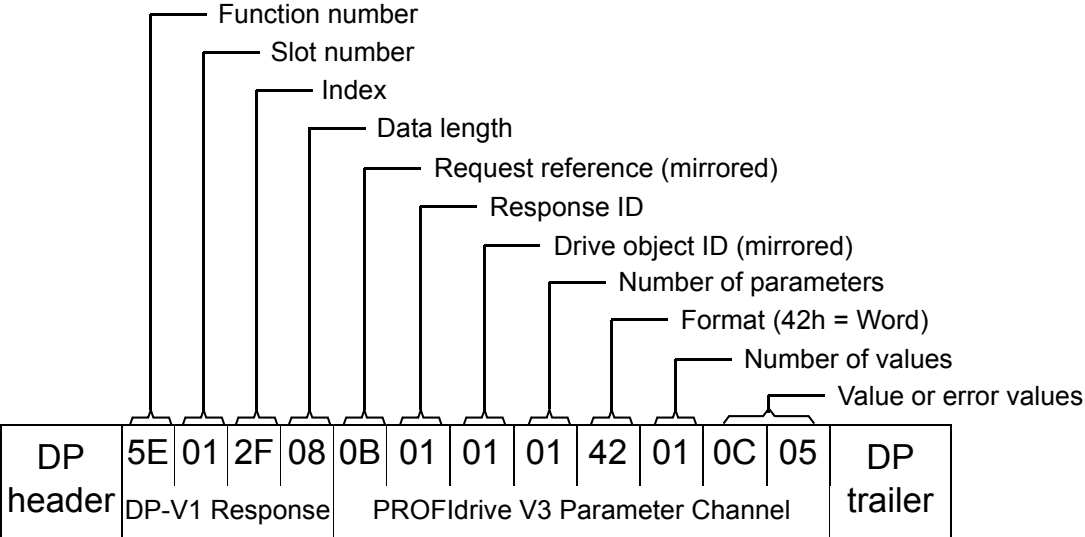

Value indicates the source of PZD3 as drive par. 12.05 (0C.05h).

Diagnostics

LED indications

The FPBA-01 module is equipped with three bicolour diagnostic LEDs. The LEDs are described below.

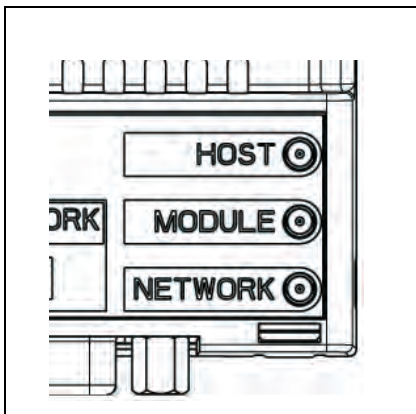

Name	Colour	Function
HOST	Green	Connection to host OK
	Blinking red	Establishing communication to host, or communication to host lost
MODULE	Green	Module status OK
	Blinking red	Configuration mismatch
	Blinking red in unison with HOST (blinking red)	Establishing communication to host
	Blinking green in unison with NETWORK (blinking red)	Network connection lost
	Blinking green once per second with NETWORK steady green	No communication with this node
	Blinking green 3 times per second with NETWORK steady green	Only Class 2 master connection (no cyclic communication established)
	Red	Module fault

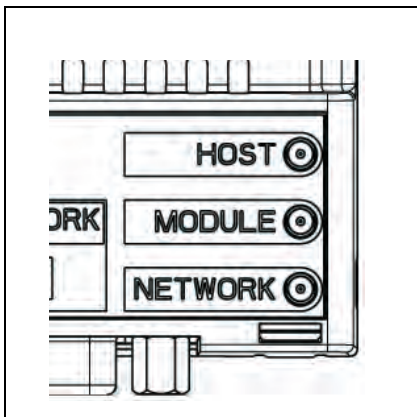

Name	Colour	Function
NETWORK	Blinking green	Establishing network connection
	Green	Network connection OK
	Blinking red	Network connection lost

PROFIdrive parameters

PROFIdrive profile-specific parameters

Parameter	R/W*	Data type	Description																																
915	R/W	Array [10] Unsigned16	Assignment PZD1 to PZD10 in PPO-write																																
916	R/W	Array [10] Unsigned16	Assignment PZD1 to PZD10 in PPO-read																																
918	R/W	Unsigned16	Node address. Writing this parameter will change the node address. Module re-start required.																																
919	R	Octet String4	Device system number.																																
923	R	Array [n] Unsigned16	<p>List of all parameters for signals. Mandatory if process data normalization is used and/or parameters 915 and 916 are implemented.</p> <table border="0"> <thead> <tr> <th>Signal no. and name</th> <th>Type</th> </tr> </thead> <tbody> <tr> <td>1 – Control word 1 (STW1)</td> <td>Unsigned16</td> </tr> <tr> <td>2 – Status word 1 (ZSW1)</td> <td>Unsigned16</td> </tr> <tr> <td>3 – Control word 2 (STW2)</td> <td>Unsigned16</td> </tr> <tr> <td>4 – Status word 2 (ZSW2)</td> <td>Unsigned16</td> </tr> <tr> <td>5 – Speed setpoint A (NSOLL_A)</td> <td>Signed16</td> </tr> <tr> <td>6 – Speed actual value A (NIST_A)</td> <td>Signed16</td> </tr> <tr> <td>7 – Speed setpoint B (NSOLL_B)</td> <td>Signed32</td> </tr> <tr> <td>8 – Speed actual value B (NIST_B)</td> <td>Signed32</td> </tr> <tr> <td>27 – Position setpoint A (XSOLL_A)</td> <td>Signed32</td> </tr> <tr> <td>28 – Position actual value A (XIST_A)</td> <td>Signed32</td> </tr> <tr> <td>32 – Traversing block selection (SATZANW) (not supported)</td> <td>Unsigned16</td> </tr> <tr> <td>33 – Actual traversing block (AKTSATZ) (not supported)</td> <td>Unsigned16</td> </tr> <tr> <td>34 – Target position (TARPOS_A) (not supported)</td> <td>Signed32</td> </tr> <tr> <td>35 – Velocity (VELOCITY_A)</td> <td>Unsigned32</td> </tr> <tr> <td>101 ... 9999 – Drive-specific</td> <td>–</td> </tr> </tbody> </table>	Signal no. and name	Type	1 – Control word 1 (STW1)	Unsigned16	2 – Status word 1 (ZSW1)	Unsigned16	3 – Control word 2 (STW2)	Unsigned16	4 – Status word 2 (ZSW2)	Unsigned16	5 – Speed setpoint A (NSOLL_A)	Signed16	6 – Speed actual value A (NIST_A)	Signed16	7 – Speed setpoint B (NSOLL_B)	Signed32	8 – Speed actual value B (NIST_B)	Signed32	27 – Position setpoint A (XSOLL_A)	Signed32	28 – Position actual value A (XIST_A)	Signed32	32 – Traversing block selection (SATZANW) (not supported)	Unsigned16	33 – Actual traversing block (AKTSATZ) (not supported)	Unsigned16	34 – Target position (TARPOS_A) (not supported)	Signed32	35 – Velocity (VELOCITY_A)	Unsigned32	101 ... 9999 – Drive-specific	–
Signal no. and name	Type																																		
1 – Control word 1 (STW1)	Unsigned16																																		
2 – Status word 1 (ZSW1)	Unsigned16																																		
3 – Control word 2 (STW2)	Unsigned16																																		
4 – Status word 2 (ZSW2)	Unsigned16																																		
5 – Speed setpoint A (NSOLL_A)	Signed16																																		
6 – Speed actual value A (NIST_A)	Signed16																																		
7 – Speed setpoint B (NSOLL_B)	Signed32																																		
8 – Speed actual value B (NIST_B)	Signed32																																		
27 – Position setpoint A (XSOLL_A)	Signed32																																		
28 – Position actual value A (XIST_A)	Signed32																																		
32 – Traversing block selection (SATZANW) (not supported)	Unsigned16																																		
33 – Actual traversing block (AKTSATZ) (not supported)	Unsigned16																																		
34 – Target position (TARPOS_A) (not supported)	Signed32																																		
35 – Velocity (VELOCITY_A)	Unsigned32																																		
101 ... 9999 – Drive-specific	–																																		

Parameter	R/W*	Data type	Description
927	R/W	Unsigned16	Operator control rights (parameter identification, PKW). Value Mode 0 Parameters cannot be written, only read (927 can be written) 1 Parameters can be written and read (default).
928	R/W	Unsigned16	Control rights (process data, PZD). Value Mode 0 PZD part is disabled, i.e. Receipt of new PZD data is ignored 1 PZD part is enabled (default).
929	R	Unsigned16	Selected PPO type Value PPO type Configuration 1 PPO1 F3h, F1h 2 PPO2 F3h, F5h 3 PPO3 F1h 4 PPO4 F5h 5 PPO5 F3h, F9h 6 PPO6 F9h Note: This parameter is not available if Standard telegram ST1 or ST2 is selected.
930	R/W	Unsigned16	Selection switch for communication profile. Value Mode 1 PROFIdrive 8001h ABB Drives 8002h Transparent 16 8003h Transparent 32 8004h PROFIdrive positioning mode
933	R/W	Unsigned16	Selection switch for Control word, bit 11. Value Module Control word bit 0 None 1 to 5 Vendor specific 1 to 5* * The meaning of vendor specific bits is defined by drive application program.

Parameter	R/W*	Data type	Description
934	R/W	Unsigned16	Selection switch for Control word, bit 12. (See parameter 933 for coding)
935	R/W	Unsigned16	Selection switch for Control word, bit 13. (See parameter 933 for coding)
936	R/W	Unsigned16	Selection switch for Control word, bit 14. (See parameter 933 for coding)
937	R/W	Unsigned16	Selection switch for Control word, bit 15. (See parameter 933 for coding)
939	R/W	Unsigned16	Selection switch for Status word, bit 11. Value Module Status word bit 0 None 1 to 4 Vendor specific 1 to 4* * The meaning of vendor specific bits is defined by drive application program.
940	R/W	Unsigned16	Selection switch for Status word, bit 12. (See parameter 939 for coding)
941	R/W	Unsigned16	Selection switch for Status word, bit 13. (See parameter 939 for coding)
942	R/W	Unsigned16	Selection switch for Status word, bit 14. (See parameter 939 for coding)
943	R/W	Unsigned16	Selection switch for Status word, bit 15. (See parameter 939 for coding)
945	R	Array[64] Unsigned16	Fault code (coded according to DRIVECOM profile). Note: The drive may limit the actual number of faults recorded. Subindex Contents 1 Active fault 9 **Last ackn. fault 17 **Second last ackn. fault 25 **Third last ackn. fault 33 **Fourth last ackn. fault 41 **Fifth last ackn. fault
947	R	Array [64] Unsigned16	Fault number. Subindex Contents See parameter 945.

Parameter	R/W*	Data type	Description																
952	R/W	Unsigned16	Number of faults occurred. Writing a zero clears the value.																
953	R	Unsigned16	**Last alarm																
954	R	Unsigned16	**Second last alarm																
955	R	Unsigned16	**Third last alarm																
956	R	Unsigned16	**Fourth last alarm																
957	R	Unsigned16	**Fifth last alarm																
958	R	Unsigned16	Sixth last alarm (not supported)																
959	R	Unsigned16	Seventh last alarm (not supported)																
960	R	Unsigned16	Eighth last alarm (not supported)																
961	R	Octet String4	Hardware configuration (manufacturer specific ID of the drive)																
963	R	Unsigned16	Detected baud rate: 0 = 9.6 kbit/s 1 = 19.2 kbit/s 2 = 93.75 kbit/s 3 = 187.5 kbit/s 4 = 500 kbit/s 6 = 1.5 Mbit/s 7 = 3 Mbit/s 8 = 6 Mbit/s 9 = 12 Mbit/s 11 = 45.45 kbit/s 255 = Invalid baud rate																
964	R	Array [7] Unsigned16	<table border="0"> <thead> <tr> <th>Subindex</th> <th>Contents</th> </tr> </thead> <tbody> <tr> <td>0</td> <td>Manufacturer</td> </tr> <tr> <td>1</td> <td>Device type</td> </tr> <tr> <td>2</td> <td>Version</td> </tr> <tr> <td>3</td> <td>Firmware date (year)</td> </tr> <tr> <td>4</td> <td>Firmware date (day/month)</td> </tr> <tr> <td>5</td> <td>Number of Axes</td> </tr> <tr> <td>6</td> <td>Identification (0959h)</td> </tr> </tbody> </table>	Subindex	Contents	0	Manufacturer	1	Device type	2	Version	3	Firmware date (year)	4	Firmware date (day/month)	5	Number of Axes	6	Identification (0959h)
Subindex	Contents																		
0	Manufacturer																		
1	Device type																		
2	Version																		
3	Firmware date (year)																		
4	Firmware date (day/month)																		
5	Number of Axes																		
6	Identification (0959h)																		
965	R	Octet String2	Profile number of this device. E.g. 0302h = Profile 3, Version 2																
967	R	Unsigned16	Control word (CW)																
968	R	Unsigned16	Status word (SW)																

Parameter	R/W*	Data type	Description
970	R/W	Unsigned16	Load parameter record Value Description 0 No action 1 Restore factory settings The parameter must do a zero-to-one transition and the motor must be stopped.
971	R/W	Unsigned16	Save parameter record Value Description 0 No action 1 Save the drive parameters to non-volatile memory The parameter must do a zero-to-one transition and the motor must be stopped.
972	R/W	Unsigned16	Software reset Value Description 0 No action 1 Re-boot PROFIBUS module The parameter must do a zero-to-one transition and the motor must be stopped.
975	R	Array[n] Unsigned16	DO identification. For subindexes 0...4, see parameter 964. Subindex Meaning 5 Value 2 = Axis 6 Bit 0=1 -> Application Class 1 supported Bit 2=1 -> Application Class 3 supported
980 981	R	Array[n] Unsigned16	Number list of defined parameters. If the subindex is 0, the end of the list has been reached. If the subindex is the number of the next list parameter, the list is continued there.

* Read and/or Write

** Support depends on drive type

I&M (Identification & Maintenance) records

I&M records can be read e.g. with the DTM tool. The FPBA-01 supports the mandatory I&M0 record as well as the optional I&M1 and I&M2 records.

Call-REQ-PDU telegram for read/write access to I&M records:

	Contents	Size	Coding	Notes
DP-V1 header	Function_Num	1 Octet	5Fh	fixed
	Slot_Number	1 Octet	0...255	variable
	Index	1 Octet	255	fixed
	Length	1 Octet	4 / 68	Call Header only / Write
Call Header	Extended_Function_Num	1 Octet	08h	Indicates "Call", fixed
	reserved	1 Octet	00h	fixed
	FI_Index	2 Octets	65000...	Subindex of I&M0 Record 65000 = I&M0 65001 = I&M1 65002 = I&M2
	IM_Function	64 Octets	Data	Write only (I&M1 or I&M2)

Response structure for I&M0 (Read-only)

	Contents	Size	Coding
Header	Manufacturer-specific	10 Octets	"FPBA-01"
I&M block	MANUFACTURER_ID	2 Octets	0x1A = ABB Automation
	ORDER_ID	20 Octets	"68469325" (for FPBA-01 kit)
	SERIAL_NUMBER	16 Octets	Serial number of FPBA module
	HARDWARE_REVISION	2 Octets	Hardware version of FPBA module
	SOFTWARE_REVISION	4 Octets	Format: V255.255.255 E.g. V1.0.0 = software version 100A
	REVISION_COUNTER	2 Octets	(marks a change of hardware or its parameters)
	PROFILE_ID	2 Octets	3A00 (...3AFF) PROFdrive
	PROFILE_SPECIFIC_TYPE	2 Octets	0 = no specific type
	IM_VERSION	2 Octets	0x0101 = version 1.1
	IM_SUPPORTED	2 Octets	3 = I&M0, I&M1 and I&M2 supported

Response structure for I&M1 (Read/Write)

	Contents	Size	Coding
Header	Manufacturer-specific	10 Octets	–
I&M0 block	TAG_FUNCTION	32 Octets	Device function or task
	TAG_LOCATION	22 Octets	Device location

Response structure for I&M2 (Read/Write)

	Contents	Size	Coding
Header	Manufacturer-specific	10 Octets	–
I&M0 block	INSTALLATION_DATE	16 Octets	Installation date. E.g. 2007-01-01 16:23
	RESERVED	38 Octets	Reserved

Note: I&M1 and I&M2 are blank (0x20) by default.

Definitions and abbreviations

PROFIBUS definitions

<i>Acyclic Communication</i>	Communication in which messages are sent only once on request
<i>Array</i>	Parameter consisting of data fields of equal data type
<i>Broadcast</i>	Non-acknowledged message from master to all bus participants (compare Multicast)
<i>Command Word</i>	See Control Word
<i>Communication Object</i>	Any object of a real device that can be communicated with (variable, program, data range, etc.). Stored locally in the Object Dictionary.
<i>Control Word</i>	16-bit word from master to slave with bit-coded control signals (sometimes called the Command Word).
<i>Cyclic Communication</i>	Communication in which Parameter-/Process Data-Objects are sent cyclically at pre-defined intervals
<i>Device Class</i>	Classification according to the number of profile functions included in the device
<i>Drivecast</i>	Broad- and Multicast, a special message frame for drives
<i>Fault</i>	Event that leads to tripping of the device
<i>GSD File</i>	ASCII-format device description file in a specified form. Each device (active & passive stations) on PROFIBUS has to have its own GSD File.
<i>Index</i>	Access reference for Objects in PROFIBUS
<i>Information Report</i>	Non-acknowledged message from master to one or all groups of bus participants

<i>Master</i>	Control system with bus initiative. In PROFIBUS terminology, master stations are also called active stations.
<i>Multicast</i>	Non-acknowledged message from master to one group of bus participants (compare Broadcast)
<i>Name</i>	Symbolic name of a parameter
<i>Nibble</i>	Set of 4 bits
<i>Object Dictionary</i>	Local storage of all Communication Objects recognised by a device
<i>Object List</i>	List of all accessible objects
<i>Parameter</i>	Value that can be accessed as Object, e.g. variable, constant, signal
<i>Parameter Number</i>	Parameter address
<i>Parameter/Process Data Object</i>	Special object that contains Parameter and Process Data
<i>Process Data</i>	Data that contains Control Word and Reference value or Status Word and Actual value. May also contain other (user-definable) control information.
<i>Profile</i>	Adaptation of the protocol for certain application field, e.g. drives
<i>Request Label</i>	Coded information specifying the required service for the parameter part sent from master to slave
<i>Response Label</i>	Coded information specifying the required service for the parameter part sent from slave to master
<i>Slave</i>	Passive bus participant. In PROFIBUS terminology, slave stations (or slaves) are also called passive stations. Also referred to as node.
<i>Status Word</i>	16-bit word from slave to master with bit-coded status messages

Warning Signal caused by an existing alarm which does not lead to tripping of the device

PROFIBUS abbreviations

The text in *italics* is the original German term.

<i>.con</i>	Confirmation
<i>.ind</i>	Indication
<i>.req</i>	Request
<i>.res</i>	Response
<i>ACT</i>	Actual Value <i>Istwert</i>
<i>AK</i>	Request Label/Response Label <i>Auftragskennung/Antwortkennung</i>
<i>ALI</i>	Application Layer Interface
<i>CR</i>	Communication Reference <i>Kommunikationsreferenz (Kommunikationsbeziehung)</i>
<i>DP</i>	Decentralised Periphery <i>Dezentrale Peripherie</i>
<i>DP-ALI</i>	Application Layer Interface for DP
<i>DP-V1</i>	PROFIBUS DP Extensions to the EN 50170 standard, including e.g. acyclic data exchange
<i>FDL</i>	Fieldbus Data Link
<i>FMS</i>	Fieldbus Message Specification
<i>FSU</i>	Manufacturer Specific Interface <i>Firmenspezifischer Umsetzer</i>
<i>HIW</i>	Main Actual Value <i>Hauptistwert</i>
<i>HSW</i>	Main Reference <i>Hauptsollwert</i>

<i>ISW</i>	see ACT
<i>KR (KB)</i>	see CR
<i>PA</i>	Process Automation <i>Prozessautomatisierung</i>
<i>PD</i>	Process Data <i>Prozessdaten</i>
<i>PKE</i>	Parameter Identification <i>Parameter-Kennung</i>
<i>PKW</i>	Parameter Identification Value <i>Parameter-Kennung-Wert</i>
<i>PNU</i>	Parameter Number <i>Parameternummer</i>
<i>PPO</i>	Parameter/Process Data Object <i>Parameter-/Prozessdaten-Objekt</i>
<i>PWE</i>	Parameter Value <i>Parameter-Wert</i>
<i>PZD</i>	see PD
<i>PZDO</i>	Process Data Object <i>Prozessdatenobjekt</i>
<i>SAP</i>	Service Access Point
<i>SOW</i>	Reference <i>Sollwert</i>
<i>SPM</i>	Request Signal <i>Spontanmeldung</i>
<i>STW</i>	Control Word <i>Steuerwort</i>
<i>ZSW</i>	Status Word <i>Zustandswort</i>

Technical data

FPBA-01

Enclosure:

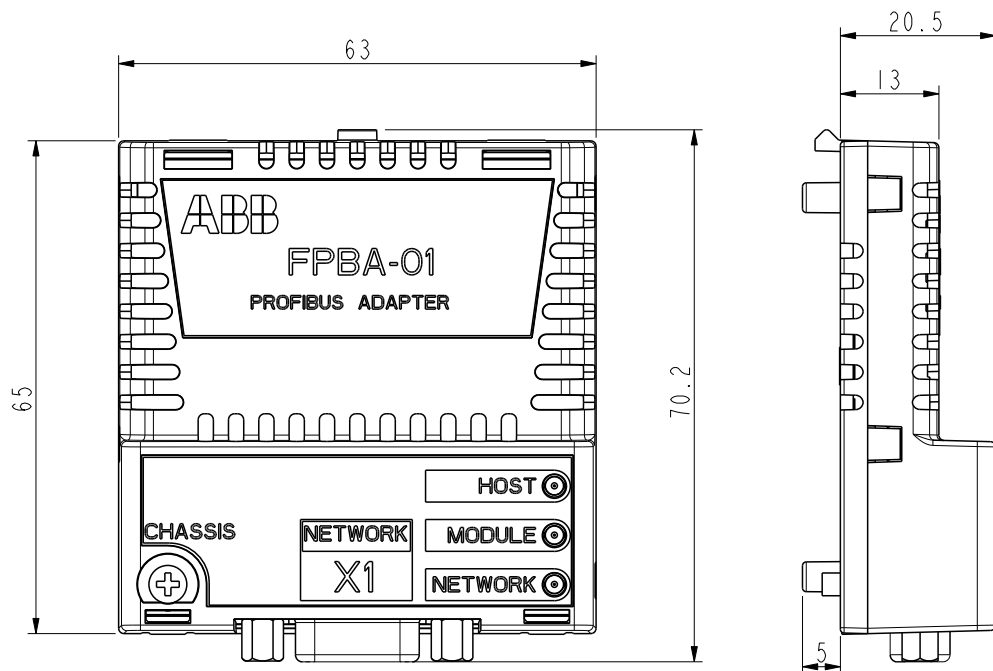

Mounting: Into the option slot on the drive.

Degree of protection: IP20

Ambient conditions: The applicable ambient conditions specified for the drive in its manuals are in effect.

Indicators: Three bicolour LEDs (HOST, MODULE, NETWORK)

Connectors:

- 20-pin connector to drive (X2)
- 9-pin D-SUB connector to bus (X1)

Power supply:

- +3.3 V $\pm 5\%$ max. 450 mA (supplied by the drive)
- Isolated +5 V supply available for bus termination circuitry (X1 pins 5 and 6). 30 mA max.

General:

- Estimated min. lifetime: 100 000 h
- All materials UL/CSA-approved
- Complies with EMC standards EN 50081-2 and EN 50082-2
- Bus interface functionally isolated from drive

PROFIBUS link

Compatible devices: All PROFIBUS-compliant devices

Medium: Shielded twisted pair RS-485 cable (PROFIBUS-approved cable recommended)

- Termination: 220 ohms, or active termination circuitry at each end of trunk cable (termination not built in the FPBA-01 module)
- Specifications:

Parameter	Line A PROFIBUS DP	Line B DIN 19245 Part 1	Unit
Impedance	135 to 165 (3 to 20 MHz)	100 to 130 (f > 100 kHz)	ohm
Capacitance	< 30	< 60	pF/m
Resistance	< 110	–	Ω /km
Wire gauge	> 0.64	> 0.53	mm
Conductor area	> 0.34	> 0.22	mm ²

- Maximum bus length:

Transfer rate (kbit/s)	≤ 93.75	187.5	500	1500	3000	6000	12000
Line A (m)	1200	1000	400	200	100	100	100
Line B (m)	1200	600	200	–	–	–	–

Topology: Trunk line, drop lines allowed. Max. 127 nodes with repeaters (31 nodes + repeater per section)

Transfer rate: 12 Mb/s max., automatically detected by the FPBA-01

Serial communication type: Asynchronous, half-duplex RS-485

Protocol: PROFIBUS DP