

# Receptacles

## Features:

- DIN Rail, Panel Mount or Wall Mount
- Rating: 15A/125V AC
- Finger Protection: IP54
- Available in 3 colors.

### PANEL MOUNT





### WALL MOUNT



### DIN RAIL MOUNT



External Dimension (HxWxL mm)	36.5 x 61.5 x 50	50 x 71 x 53.5	58.5 x 84 x 53.5
Stripping Length	10 mm	10 mm	10 mm
Insulation Material	Thermoplastic	Thermoplastic	Thermoplastic
Type of Connection	3 screw clamps	3 screw clamps	3 screw clamps
Approvals*	 E154664	 E154664	 E154664
Voltage Rating	125 V	125 V	125 V
Current Rating	15 A	15 A	15 A

Cat. No. Std. Pk.

Cat. No. Std. Pk.

Cat. No. Std. Pk.

## Complete Kit:

Blue	PMRBU	1	WMRBU	1	DMRBU	1
Gray	PMRGR	1	WMRGR	1	DMRGR	1
Black	PMRBA	1	WMRBA	1	DMRBA	1
Optional Accessory Sealing Gasket	SEALGASK	1	SEALGASK	1	SEALGASK	1

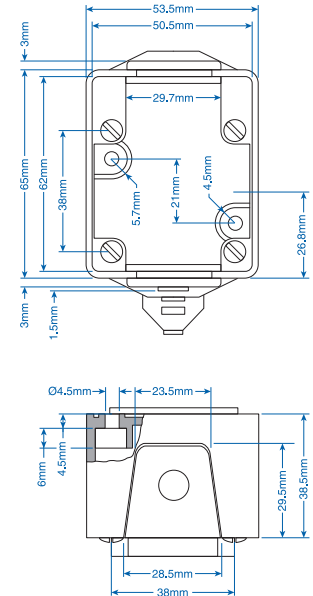
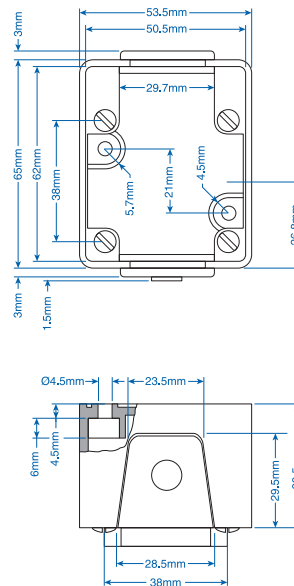
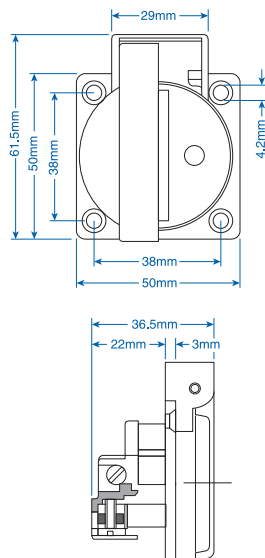

<sup>a</sup>Also applies for DIN Rail Mount Unit

**PANEL MOUNT**

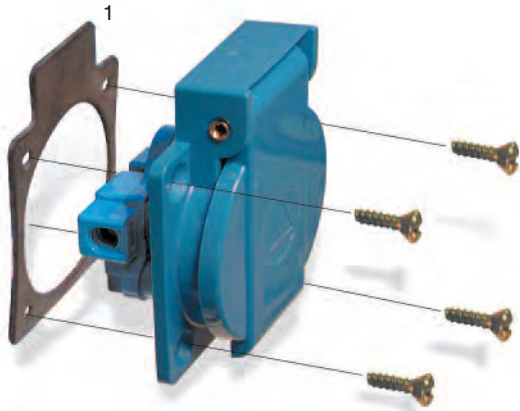

**Wiring of Receptacles**

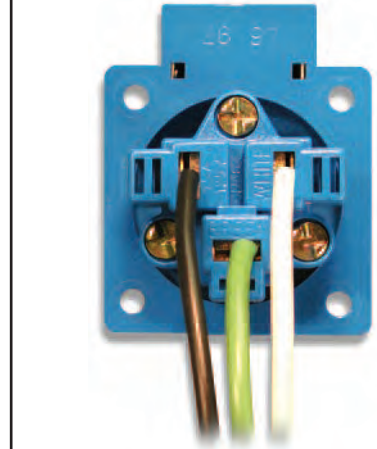

**WALL MOUNT**

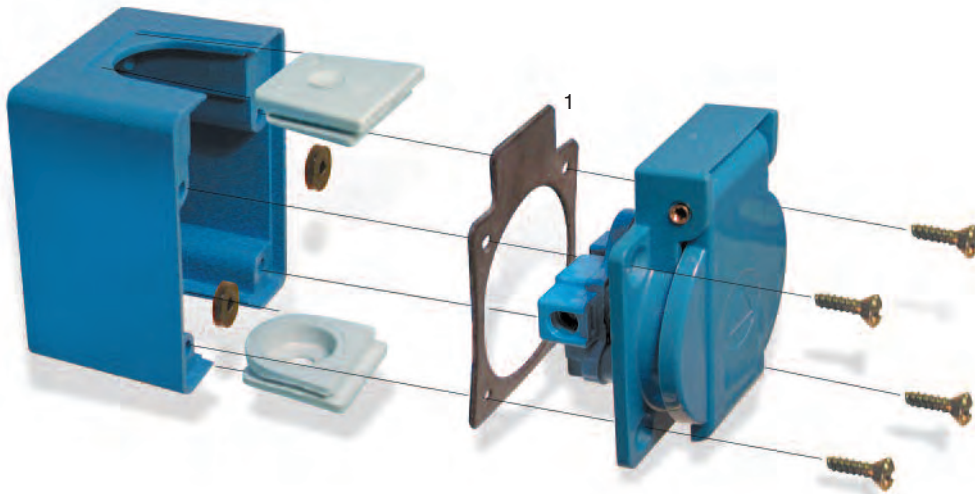

**DIN RAIL MOUNT**

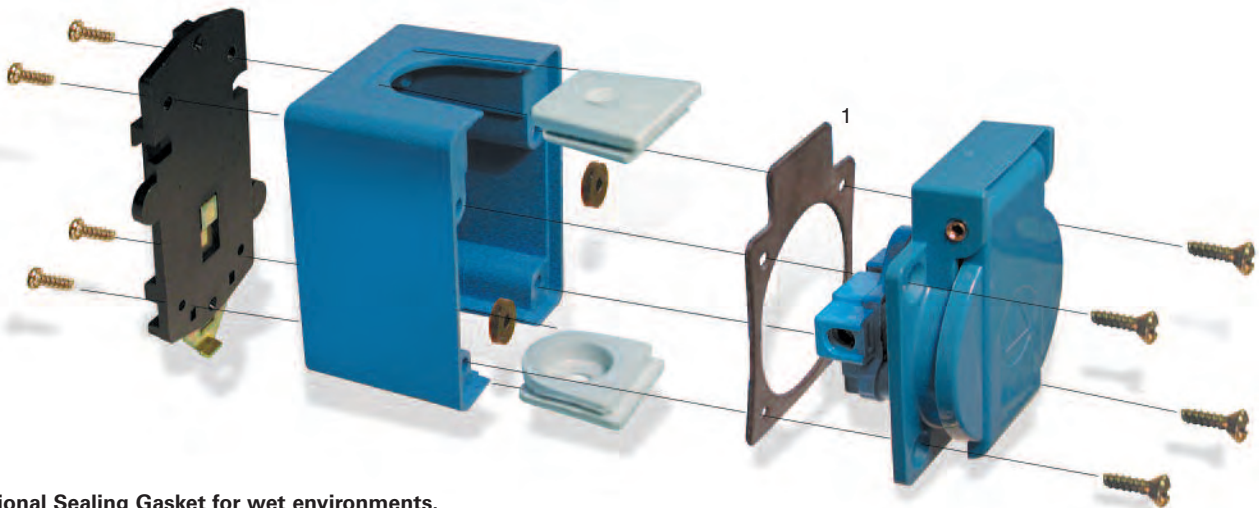

<sup>1</sup> Optional Sealing Gasket for wet environments.