



Features



- TEACH-mode sensors in the popular MINI-BEAM package
- Easy push-button programming automatically adjusts sensitivity to optimal setting
- Multiple sensing modes include: retroreflective, polarized retro, clear object detection, diffuse, divergent, and convergent, plus glass and plastic fiber optic models
- Fast, 500 microsecond (0.5 millisecond) output response
- Bipolar NPN (sinking) / PNP (sourcing) outputs
- Easy output programming eliminates the need for Light or Dark Operate selection
- Separate TEACH input allows remote programming by an external device, such as a switch or a process controller
- LED status indications for received signal strength (using Banner's AID[™] function), power ON and output state
- Green Stability indicator flashes when received signal level approaches the switching threshold, also indicates Power ON
- Integral 2 m (6.5') cable or 5-pin Euro-style quick-disconnect (QD) connector, depending on model; 9 m (30') cable models are also available

[†] U.S. patent(s) issued or pending

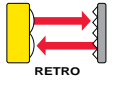
Models

Sensing Mode		Model*	Range or Focus	Supply Voltage	Output Type
Retroreflective	650 nm Visible Red	SME312LV	5 m (15'')**	10 to 30V dc	Bipolar NPN/ PNP
					
Polarized Retroreflective	650 nm Visible Red	SME312LP	10 mm to 3 m** (0.4" to 10')		
					

Sensing Mode		Model*	Range or Focus	Supply Voltage	Output Type
Polarized Retroreflective (Clear Object Detection)	650 nm Visible Red	SME312LPC	1 m (3.3') with supplied reflector**	10 to 30V dc	Bipolar NPN/ PNP
					

* Only 2 m (6.5') cable models are listed. For 9 m (30') cable, add suffix "W/30" to the model number (e.g., SME312LV W/30.) For 5-pin Euro-style QD, add suffix "QD" to the model number (e.g., SME312LVQD). A model with a QD connector requires a mating cable; see page 11.

** Sensing range will vary according to the efficiency and reflective area of the retroreflector(s) used. (Retroreflective tape is not recommended for use with Clear Object Detection models.) See page 10 and the Banner catalog for more information.

Additional models on following page.







WARNING . . . Not To Be Used for Personnel Protection

Never use these products as sensing devices for personnel protection. Doing so could lead to serious injury or death.

These sensors do NOT include the self-checking redundant circuitry necessary to allow their use in personnel safety applications. A sensor failure or malfunction can cause either an energized or de-energized sensor output condition. Consult your current Banner Safety Products catalog for safety products which meet OSHA, ANSI and IEC standards for personnel protection.

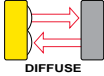
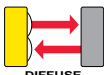
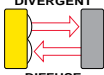
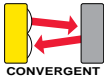
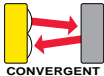
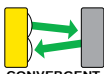
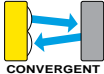
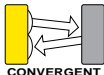
MINI-BEAM® Expert™ Series

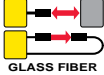
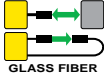
Models, continued

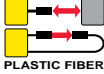
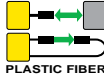
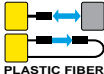
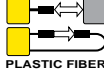
Sensing Mode		Model*	Range or Focus	Supply Voltage	Output Type	
Diffuse	880 nm Infrared 	SME312D	380 mm (15")	10 to 30V dc	Bipolar NPN/ PNP	
	650 nm Visible Red 	SME312DV	1100 mm (43")			
Divergent Diffuse	880 nm Infrared 	SME312W	130 mm (5")			
	650 nm Visible Red 	SME312CV	16 mm (0.65") Spot Size at Focus: 1.3 mm (0.05")			
Convergent	650 nm Visible Red 	SME312CV2	43 mm (1.7") Spot Size at Focus: 3.0 mm (0.12")			
	525 nm Visible Green 	SME312CVG	16 mm (0.65") Spot Size at Focus: 1.0 mm (0.04")			
	475 nm Visible Blue 	SME312CVB	16 mm (0.65") Spot Size at Focus: 1.8 mm (0.07")			
	450-650 nm Visible White 	SME312CVW	16 mm (0.65") Spot Size at Focus: 1.8 mm (0.07")			
	Glass Fiber Optic	880 nm Infrared 	SME312F			Range varies by sensing mode and fiber optics used
		650 nm Visible Red 	SME312FV			
Glass Fiber Optic	525 nm Visible Green 	SME312FVG				
	475 nm Visible Blue 	SME312FVB				
Glass Fiber Optic	450-650 nm Visible White 	SME312FVW				
	Plastic Fiber Optic	650 nm Visible Red 	SME312FP			
525 nm Visible Green 		SME312FPG				
475 nm Visible Blue 		SME312FPB				
450-650 nm Visible White 		SME312FPW				

* Only 2 m (6.5') cable models are listed. For 9 m (30') cable, add suffix "W/30" to the model number (e.g., SME312D W/30.) For 5-pin Euro-style QD, add suffix "QD" to the model number (e.g., SME312DQD). A model with a QD connector requires a mating cable; see page 11.

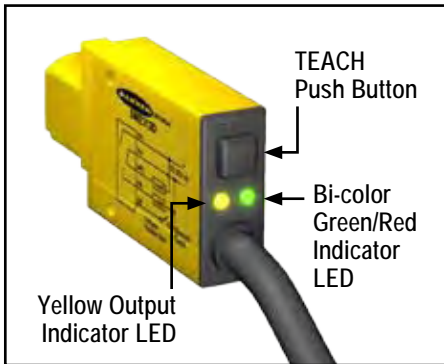

Figure 1. Features

Overview

MINI-BEAM® *Expert*™ is a complete family of sensors, all housed in the popular, robust and compact rectangular housing. Their large push button and easy-to-see indicators provide easy configuration, alignment, and monitoring during use (see Figure 1 and below).

Retroreflective and Polarized Retroreflective Mode models are excellent for sensing relatively small items where opposed-mode sensing is not possible. They are recommended for relatively clean environments where high excess gain is not required. Polarized models filter out unwanted reflections.

Polarized Retroreflective Mode – Clear Object Detection models reliably detect the presence of clear objects.

Diffuse Mode models are excellent for sensing objects of adequate size and reflectivity at short range. Divergent models are useful for sensing small items and translucent or transparent materials at close range. The SME312DV sensors effectively sense specular surfaces like semi-conductor wafers, disk drive media, glass and machined surfaces. The collimated optics of the SME312DV also permits the sensor to be mounted against clear container walls, view ports and other types of optical “feed-throughs.”

Convergent Mode models are a good choice for counting adjacent radiused objects and for accurate position sensing. Blue, green and white beam models are recommended for color mark sensing.

Glass Fiber Optic models are an excellent option for sensing in tight or otherwise inaccessible areas. Fibers withstand vibration and shock and are immune to electrical noise. Glass fibers withstand high temperatures, extreme moisture and corrosive materials. Glass fibers are not recommended for applications requiring bending or repeated flexing (see plastic fiber models). Visible beam models are recommended for color mark sensing.

Plastic Fiber Optic models are an excellent option for sensing in tight or otherwise inaccessible areas. Fibers withstand vibration and shock and are immune to electrical noise. Plastic fibers function well at temperatures from -30° to $+70^{\circ}$ C (-20° F to $+158^{\circ}$ F), and stand up to repeated flexing. Most are easy to shorten in the field, for custom installations. Plastic fibers are not recommended for severe environments (see glass fiber models). Plastic fiber optic sensors are recommended for color mark sensing.

MINI-BEAM® Expert™ Series

Status Indicators

Normal sensor operation is called RUN mode. Sensor configuration (setting the sensitivity threshold and selecting output ON and OFF conditions) is performed in TEACH mode. The two LED indicators (bi-color Green/Red and Yellow) have distinct roles in the two operation modes, as shown in Figure 2.

If contrast is marginal, the bi-color indicator will flash green to indicate instability. If this occurs, reconfigure or realign the sensor, or clean the sensor or fiber lenses.

The Signal Strength indicator is Banner's exclusive AID™ (Alignment Indicating Device). Its pulse rate increases as the received light signal strength increases (during programming). This feature simplifies accurate alignment during TEACH mode, and gives

	RUN Mode	TEACH Mode
Bi-Color Green/Red	ON Green: Power is ON Flashing Green: Sensed light level is approaching sensing threshold*	ON Red: Sensor "sees" its own modulated light source; pulse rate is proportional to the received light signal strength**
Yellow	ON: Outputs conducting OFF: Outputs not conducting	ON: Ready to TEACH output ON condition OFF: Ready to TEACH output OFF condition

* This is the Stability indicator, which signals when maintenance, realignment, or reconfiguration is needed during RUN mode.
** The faster the pulse rate, the stronger the light signal.

Figure 2. Status Indicator Conditions

a relative indication of sensing contrast between the light and dark conditions.

Remote Configuration

The remote function may be used to configure the sensor remotely or to disable the push button for security. Connect the gray wire of the sensor to ground (0V dc), with a remote programming switch connected between them. Pulse the remote line according to the diagrams in the configuration procedures. The length of the individual programming pulses is equal to the value T:

0.04 seconds "T" 0.8 seconds

Troubleshooting

The MINI-BEAM Expert's Power LED may begin to alternate flashing red/green; this indicates a microprocessor memory error. If it occurs, try reteaching the sensor, or try cycling power ON and OFF, then reteaching the sensor. If this does not solve the problem, or if it occurs frequently, replace the sensor.

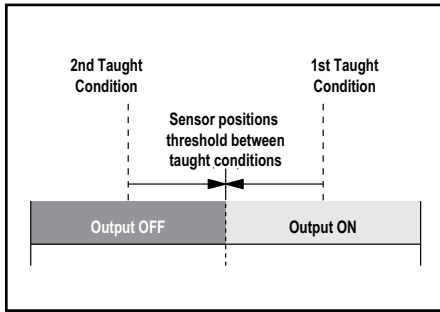

Figure 3. Static TEACH (Light Operate shown)

Static TEACH

The two sensing conditions may be presented in either order. The condition presented first is the condition for which the output will energize (the “Output ON” target).

Sensitivity is automatically set (and optimized) when teaching the sensor the ON and OFF conditions. When the push button is clicked, the sensor samples each sensing condition and registers it into memory. After the second sensing condition is registered, the MINI-BEAM Expert automatically sets the sensitivity to the optimum value for the application, and then returns to RUN mode.

	Push Button 0.04 seconds “Click” 0.8 seconds	Remote Line 0.04 seconds “T” 0.8 seconds	Result
Access TEACH Mode	<ul style="list-style-type: none"> Press and hold push button until the bi-color (green/red) indicator begins to flash red, or turns OFF. 	No action required; sensor is ready for 1st sensing condition.	<p>Push-Button Method Only</p> <p>Yellow: ON Red: Pulses to indicate relative received signal strength. Sensor is ready for output ON condition.</p>
Teach 1st Sensing Condition	<ul style="list-style-type: none"> Present 1st sensing condition. Click push button. 	<ul style="list-style-type: none"> Present 1st sensing condition. Single-pulse remote line. 	<p>Yellow: OFF Red: Pulses to indicate relative received signal strength. Sensor registers output ON condition, ready for output OFF condition.</p>
Teach 2nd Sensing Condition and Return to RUN Mode	<ul style="list-style-type: none"> Present 2nd sensing condition. Click push button. 	<ul style="list-style-type: none"> Present 2nd sensing condition. Single-pulse remote line. 	<p>Teach Accepted</p> <p>Green: ON (or flashes if signal is close to the switching threshold) Yellow: OFF, until the sensing condition changes Sensor registers output OFF condition, positions threshold, and returns to RUN mode.</p>
			<p>Teach Unacceptable</p> <p>Yellow: ON Red: Pulses to indicate relative received signal strength. Sensor returns to wait state, ready for 1st sensing condition.</p>

NOTE: The sensor will return to RUN mode if the first TEACH condition is not registered within 90 seconds. TEACH mode may be cancelled before either 1st or 2nd condition by holding the push button depressed for ≥ 2 seconds.

Push Button Enable/Disable

In addition to its programming function, the remote line may be used to disable the push buttons for security. Disabling the push buttons prevents undesired tampering with the sensor configuration settings. Connect the sensor’s gray wire as described on page 4, and four-pulse to either enable or disable the push buttons.

	Push Button	Remote Line 0.04 seconds “T” 0.8 seconds	Result
Push Button Enable/Disable	Not available	<ul style="list-style-type: none"> Four-pulse the remote line to enable or disable the push button. 	Sensor toggles between enable/disable settings and returns to RUN mode.

MINI-BEAM[®] Expert[™] Series

Specifications

Supply Voltage and Current	10 to 30V dc (10% maximum ripple) at less than 45 mA, exclusive of load
Supply Protection Circuitry	Protected against reverse polarity and transient voltages
Output Configuration	Bipolar: One current sourcing (PNP) and one current sinking (NPN) open-collector transistor
Output Rating	150 mA maximum each output at 25° C, derated to 100 mA at 70° C (derate ≈1 mA per °C) Off-state leakage current: less than 5µA @ 30V dc ON-state saturation current: less than 1V @ 10 mA; less than 1.5V @ 150 mA
Output Protection Circuitry	Protected against false pulse on power-up and continuous overload or short-circuit of outputs
Output Response Time	Sensors will respond to either a "light" or a "dark" signal of 500 microseconds or longer duration, 1 kHz max. NOTE: 1 second delay on power-up; outputs do not conduct during this time.
Repeatability	100 microseconds (all models)
Adjustments	Push-button TEACH mode sensitivity setting (see Static TEACH, page 5); remote TEACH mode input is provided (gray wire, see page 4)
Indicators	Two LEDs: Yellow and Bi-color Green/Red (see Figures 1 and 2)
Construction	Reinforced thermoplastic polyester housing, totally encapsulated, o-ring seal, acrylic lenses, and stainless steel screws.
Environmental Rating	Meets NEMA standards 1, 2, 3, 3S, 4, 4X, 6, 12, and 13; IEC IP67
Connections	PVC-jacketed 5-conductor 2 m (6.5') or 9 m (30') unterminated cable, or 5-pin Euro-style quick-disconnect (QD) fitting are available. QD cables are ordered separately; see page 11.
Operating Conditions	Temperature: -20° to +70° C (-4° to +158° F) Max. Relative Humidity: 90% at 50° C (non-condensing)
Application Notes	The first condition presented during TEACH mode becomes the output ON condition.
Certifications	

Performance Curves

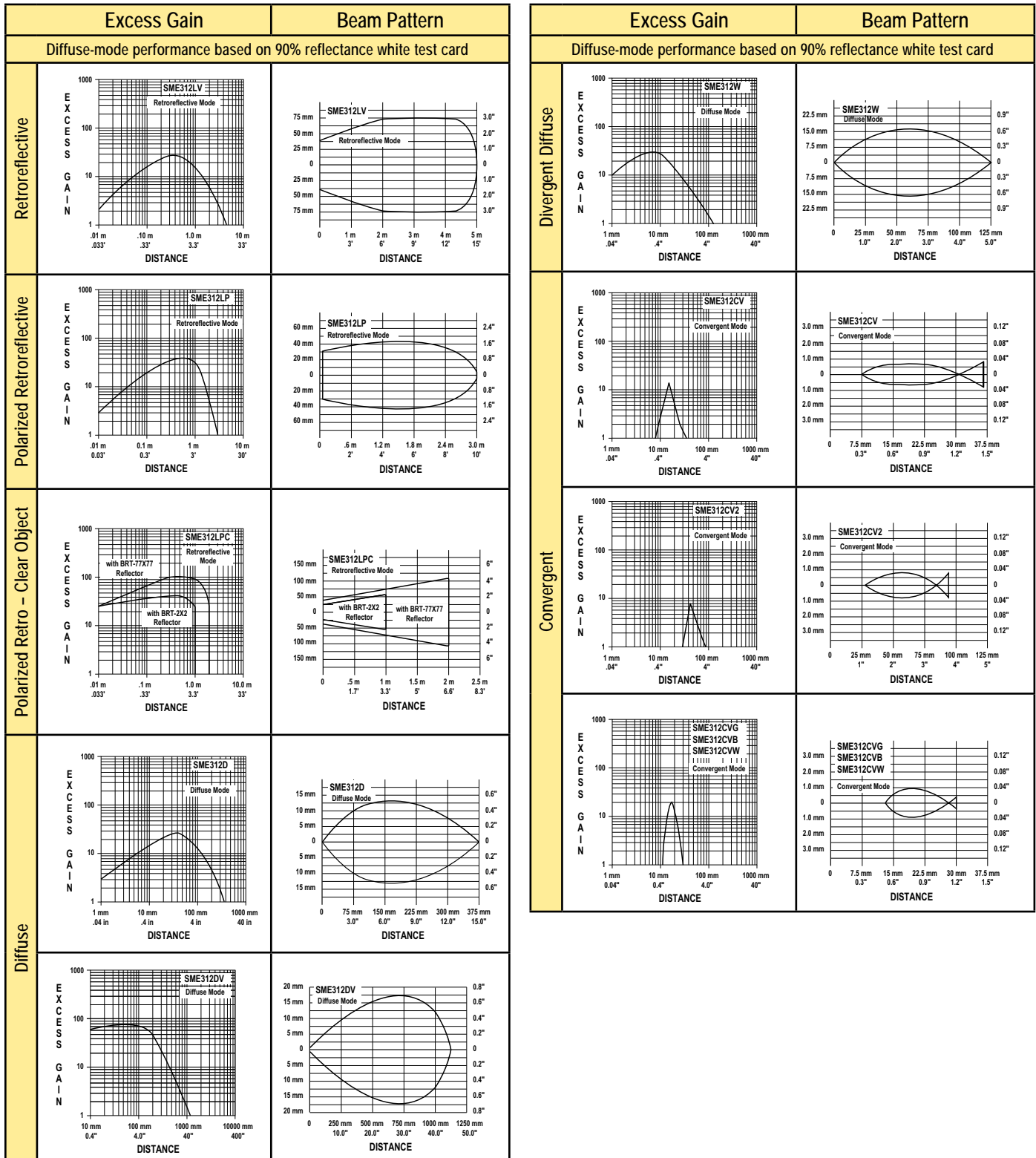

MINI-BEAM® Expert™ Series

Performance Curves, continued

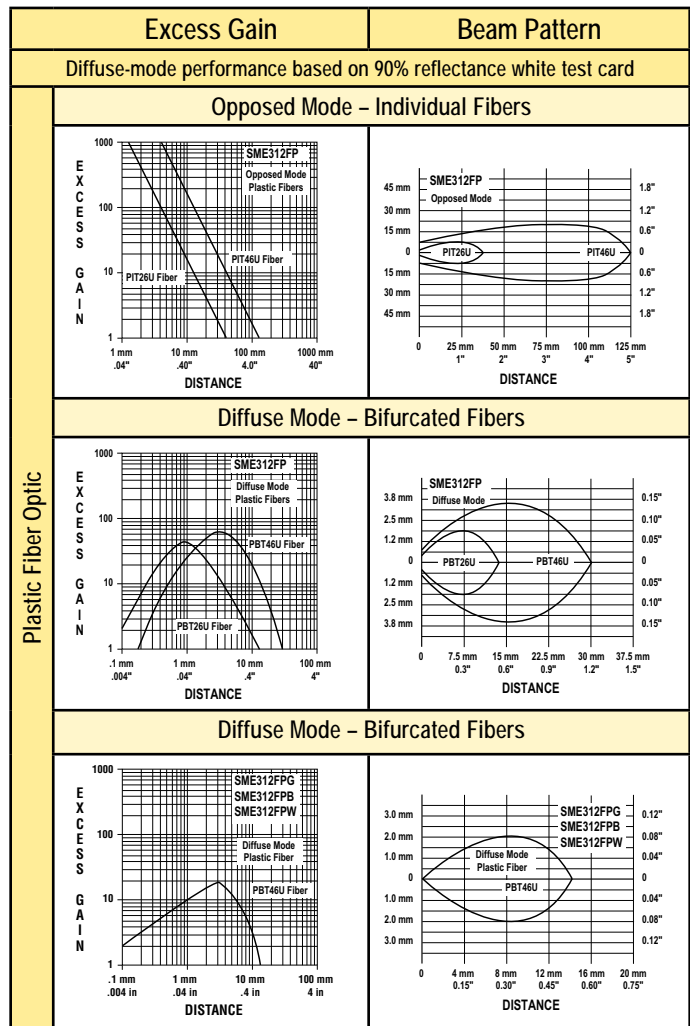
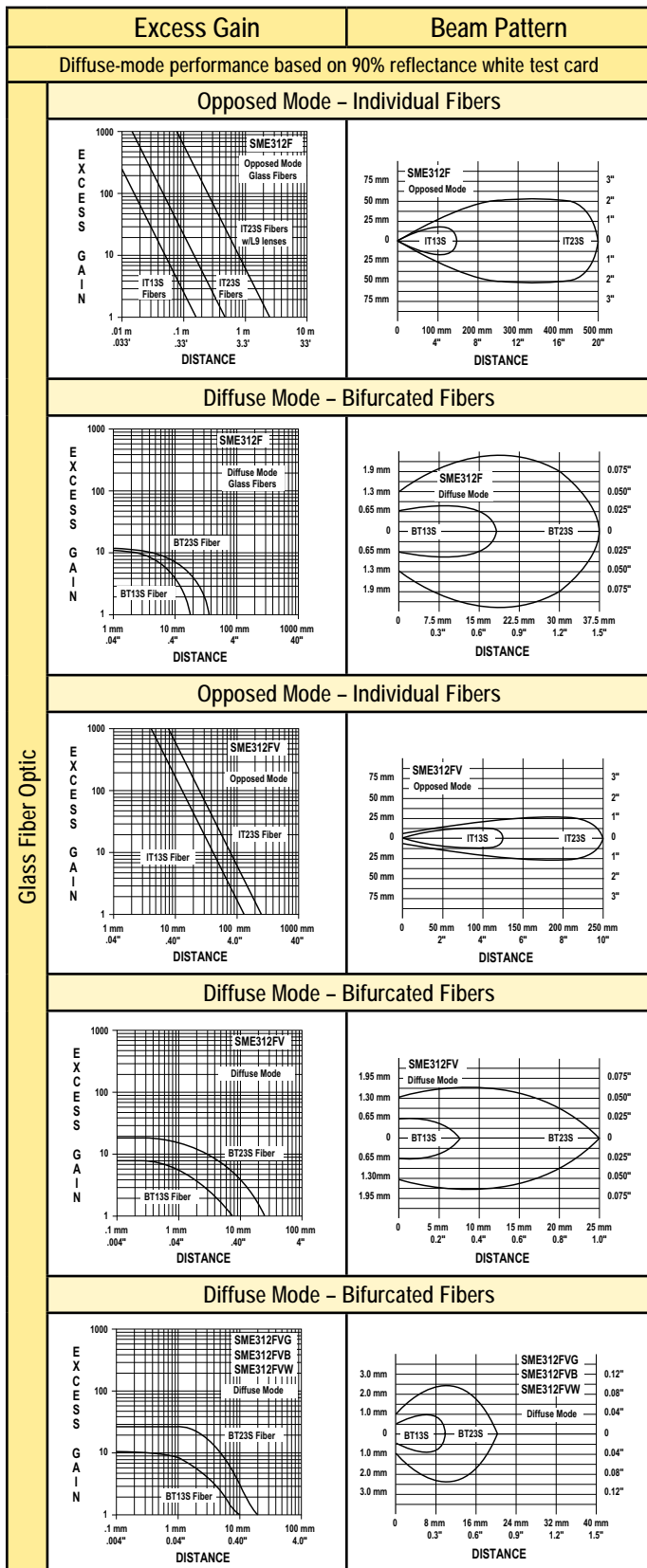

Glass Fiber Optic

Plastic Fiber Optic

Dimensions

Cabled Models (Suffix LV, LP, LPC, D, CV, CV2, CVG, CVB and CVW)

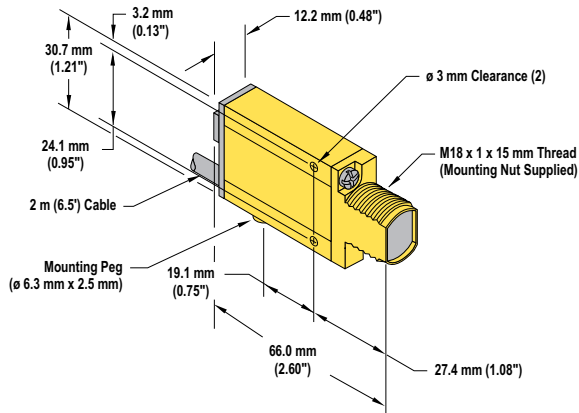

QD Models

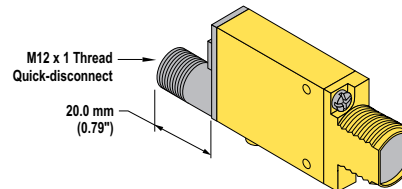

Divergent Diffuse Mode Models (Suffix W)

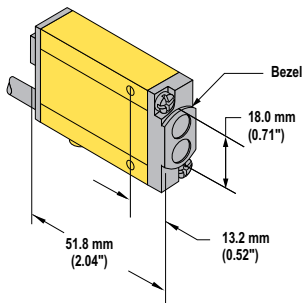

Glass Fiber Optic Models (Suffix F, FV, FVG, FVB and FWV)

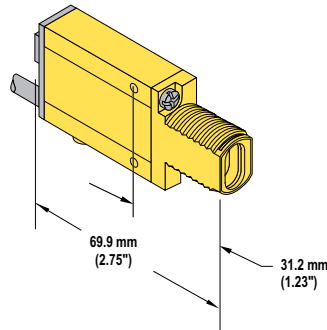

Plastic Fiber Optic Models (Suffix FP, FPG, FPB and FPW)

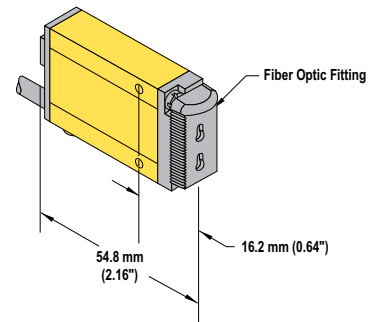

Hookups

Cabled Models

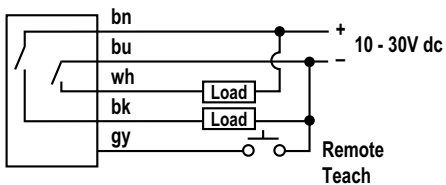

QD Models

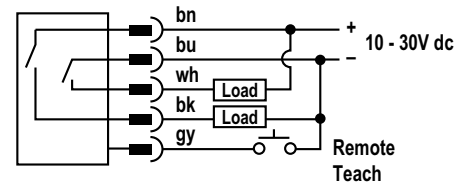

MINI-BEAM® Expert™ Series

Accessories

Retroreflective Targets

Banner offers a wide selection of high-quality retroreflective targets. See your current Banner Sensors catalog for complete information on available models.

Sensing range will vary, according to the retroreflector's efficiency and reflective area.

- For high-vibration applications: model BRT-36X40BM (micro-prism geometry) is recommended.
- For long-range applications: model BRT-77X77C reflector provides a range up to 2 m (6.5').
- For clear object detection (low-contrast applications): reflector model BRT-2X2 is recommended; one comes bundled with each SME312LPC(QD) sensor.
- Polarized sensors require corner-cube type retroreflective targets only; reflective tape is not recommended.

Before installing retroreflective tape, clean the mounting surface with an isopropyl alcohol wipe.

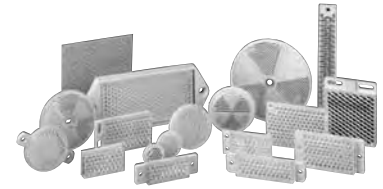

Optional brackets for mounting reflective targets are available. See the Accessories section of your current Banner catalog or our website.

<p>BRT-2X2</p>	<ul style="list-style-type: none"> • One supplied with each SME312LPC(QD) sensor • Reflectivity Factor: 1.0 • Maximum Temperature: +50° C (120° F) 	<p>BRT-36X40BM</p>	<ul style="list-style-type: none"> • Micro-prism geometry • Reflectivity Factor: 1.2 • Maximum Temperature: +50° C (120° F)
<p>BRT-77X77C</p>	<ul style="list-style-type: none"> • Reflectivity Factor: 2.0 • Maximum Temperature: +50° C (120° F) 	<p>BRT-TVHG</p>	<ul style="list-style-type: none"> • Reflectivity Factor: 0.8 • Maximum Temperature: +60° C (140° F)
		<p>Retroreflective tape is available in a variety of sizes and shapes; see your Banner Catalog for more information.</p> <p>Not recommended for use with clear object detection sensors.</p>	

MINI-BEAM® Expert™ Series

Quick-Disconnect (QD) Cables







Style	Model	Length	Dimensions	Pinout
5-pin Euro-style straight	MQDC1-506 MQDC1-515 MQDC1-530	2 m (6.5') 5 m (15') 9 m (30')		
5-pin Euro-style right-angle	MQDC1-506RA MQDC1-515RA MQDC1-530RA	2 m (6.5') 5 m (15') 9 m (30')		

Mounting Brackets

SMB312S	<ul style="list-style-type: none"> Stainless steel 2-axis, side-mount bracket 		SMB46U	<ul style="list-style-type: none"> "U" bracket 14 ga 316 stainless steel 	
SMB312B	<ul style="list-style-type: none"> Stainless steel 2-axis, bottom-mount bracket Includes mounting foot 		SMB18A	<ul style="list-style-type: none"> 12-ga. stainless steel right-angle mounting bracket with curved mounting slot for versatile orientation Clearance for M4 (#8) hardware 	
SMB312PD	<ul style="list-style-type: none"> Stainless steel 18 mm barrel-mount bracket 		SMB18FA	<ul style="list-style-type: none"> 14-ga. 304 stainless steel 18 mm swivel bracket with tilt and pan movement for precision adjusting 	
SMB46L	<ul style="list-style-type: none"> "L" bracket 14 ga 316 stainless steel 		SMB18Q	<ul style="list-style-type: none"> 12-ga. stainless steel 18 mm angled flanged bracket 	
SMB46S	<ul style="list-style-type: none"> "S" bracket 14 ga 316 stainless steel 		SMB18SF	<ul style="list-style-type: none"> 18 mm swivel, black reinforced thermoplastic polyester bracket Stainless steel mounting hardware included 	

MINI-BEAM® Expert™ Series

Mounting Brackets, continued

SMB3018SC	<ul style="list-style-type: none"> • 18 mm swivel; barrel- or side-mount • Black thermoplastic polyester 		SMB18UR	<ul style="list-style-type: none"> • 2-piece universal swivel bracket • 300 series stainless steel • Includes stainless steel swivel locking hardware 	
SMB3018SUS	<ul style="list-style-type: none"> • Side-mount swivel with extended range of motion • Black thermoplastic polyester • Includes stainless steel swivel locking hardware 		SMBAMS18P	<ul style="list-style-type: none"> • 12-ga. 300 series stainless steel • Flat SMBAMS series bracket with 18 mm hole for mounting sensors • Articulation slots for 90+° of rotation 	
SMB30SK	<ul style="list-style-type: none"> • Flat-mount swivel bracket with extended range of motion • Black thermoplastic polyester and 316 stainless steel 		SMBAMS18RA	<ul style="list-style-type: none"> • 12-ga. 300 series stainless steel • Right-angle SMBAMS series bracket with 18 mm hole for mounting sensors • Articulation slots for 90+° of rotation 	



more sensors, more solutions

WARRANTY: Banner Engineering Corp. warrants its products to be free from defects for one year. Banner Engineering Corp. will repair or replace, free of charge, any product of its manufacture found to be defective at the time it is returned to the factory during the warranty period. This warranty does not cover damage or liability for the improper application of Banner products. This warranty is in lieu of any other warranty either expressed or implied.