

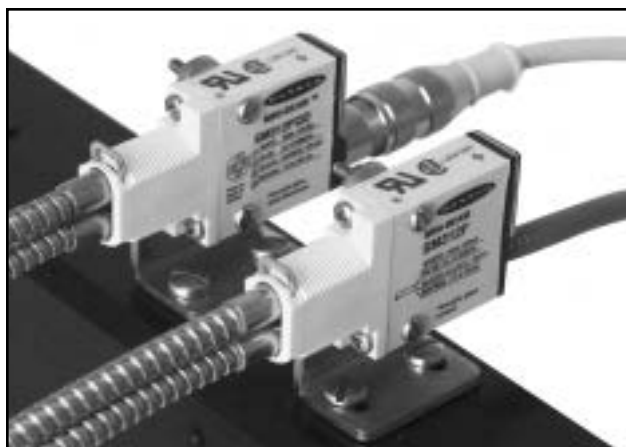

# MINI-BEAM<sup>®</sup> SM312F

Self-contained DC-operated Sensors for use with Banner Glass Fiber Optics



- Compact, modulated, self-contained infrared fiber optic sensors for 10-30V dc operation
- Useable in opposed, retroreflective, and diffuse fiberoptic modes with Banner glass fiber optic assemblies
- Switch-selectable for light operate or dark operate
- Includes Banner's *exclusive* AID™ alignment system; US patent number 4356393
- Highly-repeatable 1 millisecond response
- Both sourcing and sinking outputs (150 mA max. each); continuous overload and short-circuit protected



Infrared, 880 nm

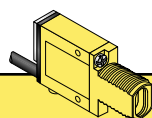

## MINI-BEAM Glass Fiber Optic

Models	Range	Cable*	Supply Voltage	Output Type	Excess Gain	Beam Pattern
					Diffuse mode performance based on 90% reflectance white test card	
SM312F SM312FQD	Range varies by sensing mode and fiber optics used	2 m (6.5 ft) 4-Pin Euro QD	10-30V dc	Bipolar NPN/PNP		

**NOTES:**

- 9 m (30') cables are available by adding suffix "W/30" to the model number of any cabled sensor (e.g., SM312F W/30).
- A 150 mm (6") long pigtail cable with attached QD connector is available by adding suffix "QDP" to the model number of any MINI-BEAM sensor (e.g., SM312FQDP). See page 5 for more information.
- A model with a QD connector requires an accessory mating cable. See page 5 for more information.
- May be ordered with 0.3 millisecond on/off response by adding suffix "MHS" to the model numbers (e.g., SM312FMHS). This modification reduces sensing range (and excess gain).

# MINI-BEAM<sup>®</sup> Sensors SM312F

## MINI-BEAM Features

**\* Note regarding Light/Dark operate switch:**

- Turn switch *fully* clockwise for light operate (sensor outputs conduct when sensing light is received)
- Turn switch *fully* counterclockwise for dark operate (sensor outputs conduct when sensing light is not received)

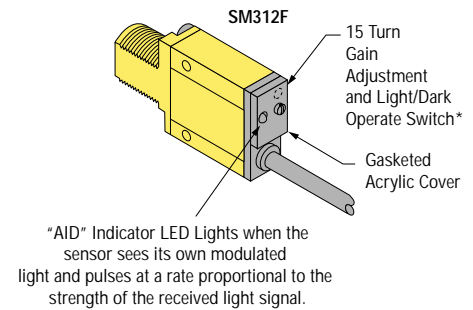

## MINI-BEAM Fiber Information

- 1) Install the O-ring (supplied with the fiber) on each fiber end, as shown in the drawing.
- 2) While pressing the fiber ends firmly into the ports on the front of the sensor, slide the U-shaped retaining clip (supplied with the sensor) into the slot in the sensor's barrel, until it snaps into place.

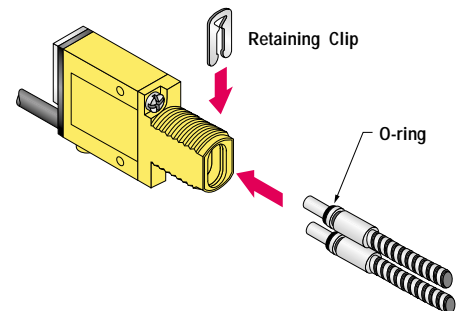

## Lens Attachment

Lenses are sometimes added to fiber optic assemblies for extending opposed mode sensing range. Banner offers the following lens assemblies for use with fiber optic assemblies which have 5/16" -24 threaded sensing tips (e.g. fiber model IT23S):

Model	Lens Size	Focal Length	Housing	Notes
L9	12.5 mm (0.5")	12.5 mm (0.5")	Aluminum	Suitable for all but highly corrosive environments
L16F	25 mm (1")	44 mm (1.7")	Delrin	Maximum operating temperature is 100° C (212° F)
L16FAL	25 mm (1")	44 mm (1.7")	Aluminum	Suitable for all but highly corrosive environments
L16FSS	25 mm (1")	44 mm (1.7")	Stainless Steel	Suitable for all environments

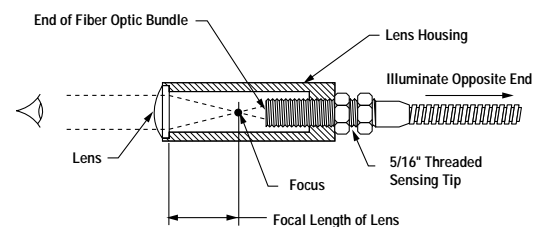

Lenses are most efficient when they are located slightly beyond their focal length distance from the sensing end of the fiber optic bundle. The easiest way to focus a lens is to treat it like a magnifying glass.

Illuminate the fiber optic bundle at the threaded end of the fiber optic assembly by directing the opposite end toward a visible light source (e.g. - an incandescent bulb, visible LED, sunlight, etc.). Thread the lens onto the fiber optic assembly until the end of the fiber optic bundle comes into sharp focus under the lens. Then, back off (unthread) the lens assembly from the point of sharpest focus by one to three full turns. The illuminated bundle should now appear slightly blurred. This is the optimum setting, and the lens may be secured in position using one of the jam nuts provided. Refer to the drawing above.

MINI-BEAM DC Product Specifications	
Supply Voltage and Current	10 to 30V dc (10% maximum ripple) at less than 25 mA (exclusive of load)
Supply Protection Circuitry	Protected against reverse polarity and transient voltages
Output Configuration	Bipolar: One current sourcing (PNP) and one current sinking (NPN) open-collector transistor
Output Rating	150mA maximum each output at 25°C, derated to 100 mA at 70°C (derate ≈1 mA per °C) <b>Off-state leakage current</b> less than 1 microamp <b>Output saturation voltage</b> (PNP output) less than 1 volt at 10 mA and less than 2 volts at 150 mA <b>Output saturation voltage</b> (NPN output) less than 200 millivolts at 10 mA and less than 1 volt at 150 mA
Output Protection Circuitry	Protected against false pulse on power-up and continuous overload or short-circuit of outputs
Output Response Time	Sensors will respond to either a "light" or a "dark" signal of 1 millisecond or longer duration, 500 Hz max. 0.3 millisecond response modification is available. See note below. 100 millisecond delay on power-up: outputs do not conduct during this time.  NOTE: DC MINI-BEAMS may be ordered with 0.3 millisecond on/off response by adding suffix "MHS" to the model numbers (e.g., <b>SM312FMHS</b> ). This modification reduces sensing range (and excess gain).
Repeatability	0.3 milliseconds. Response time and repeatability specifications are independent of signal strength.
Adjustments	LIGHT/DARK OPERATE select switch, and 15-turn slotted brass screw GAIN (sensitivity) adjustment potentiometer (clutched at both ends of travel). Both controls are located on rear panel of sensor and protected by a gasketed, clear acrylic cover.
Indicators	Exclusive, patented Alignment Indicating Device system (AID™, US patent #4356393) lights a rear-panel mounted red LED indicator whenever the sensor sees a "light" condition, with a superimposed pulse rate proportional to the light signal strength (the stronger the signal, the faster the pulse rate).
Construction	Reinforced PBT thermoplastic polyester housing, totally encapsulated, o-ring sealing, acrylic lenses, and stainless steel screws.
Environmental Rating	Meets NEMA standards 1, 2, 3, 3S, 4, 4X, 6, 12, and 13; IEC IP67
Connections	PVC-jacketed 4-conductor 2 m (6.5 ft) or 9 m (30 ft) cables, or 4-pin euro-style quick disconnect (QD) fitting are available. QD cables are ordered separately. See page 5.
Operating Temperature	<b>Temperature:</b> -20° to +70°C (-4° to +158°F) <b>Maximum relative humidity:</b> 90% at 50°C (non-condensing)
Application Notes	The NPN (current sinking) output of dc MINI-BEAM sensors is directly compatible as an input to Banner logic modules, including all non-amplified MAXI-AMP and MICRO-AMP modules. MINI-BEAMS are TTL compatible.
Certifications	

## MINI-BEAM DC Hookup Diagrams

### DC Sensors with Attached Cable

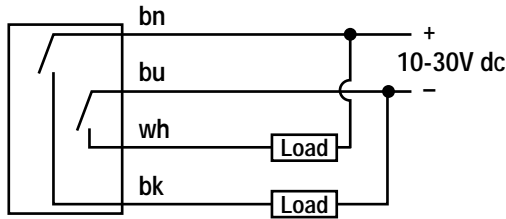

### DC Sensors with Quick Disconnect (4-Pin Euro-Style)

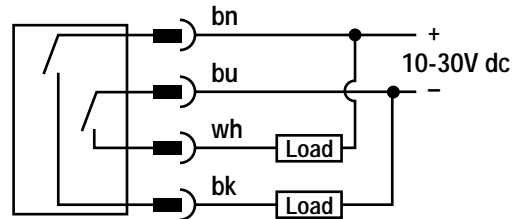

### 4-Pin Euro-Style Pin-out (Cable Connector Shown)

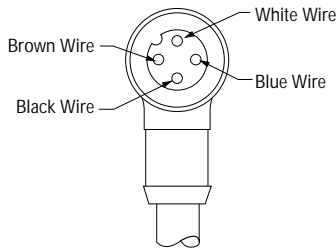

### Quick Disconnect (QD) Option

DC MINI-BEAM sensors are sold with either a 2 m (6.5') or a 9 m (30') attached PVC-covered cable, or with a 4-pin Euro-style QD cable fitting.

DC QD sensors are identified by the letters "QD" in their model number suffix. For more information on mating QD cables, see page 5.

## MINI-BEAM Dimensions

### MINI-BEAM DC Sensor with Integral Cable

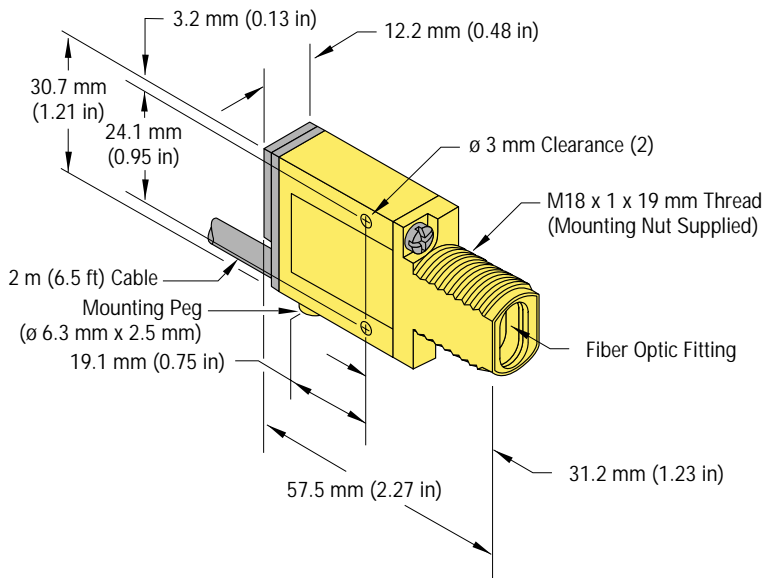

### MINI-BEAM DC Sensor with Quick-Disconnect

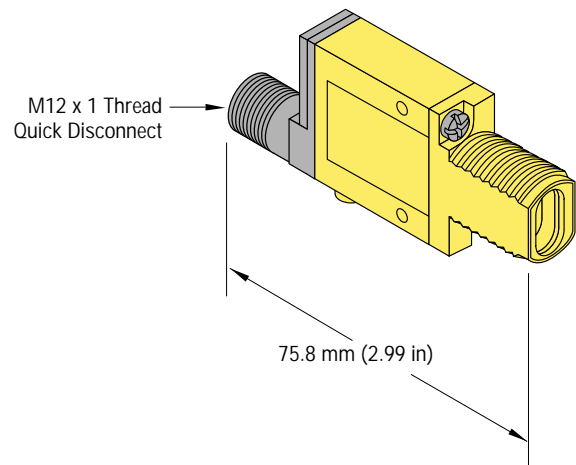





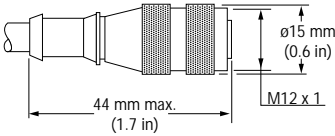
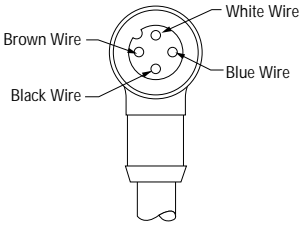
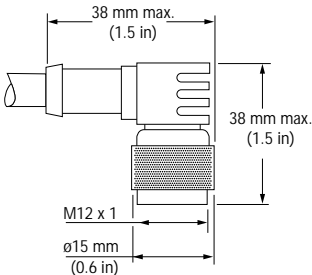

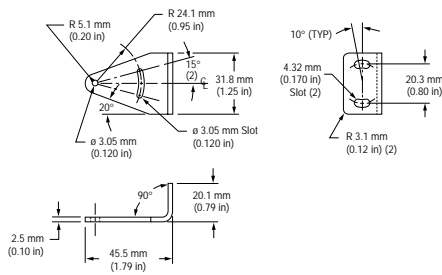

MINI-BEAM Modifications			
Model Suffix	Modification	Description	Example of Model Number
W/30	9 meter (30') cable	All MINI-BEAM sensors may be ordered with an integral 9 m (30') cable in place of the standard 2 m (6.5') cable	SM312F W/30
MHS	Modified for High Speed	Standard dc MINI-BEAM sensors with 1 millisecond output response may be modified for 0.3 millisecond (300 μs) response. NOTE: Faster response comes at the expense of lower excess gain. Also, operating temperature range becomes -20° to +50°C (-4° to +122°F)	SM312FMHS
QDP	Pigtail Quick Disconnect	All MINI-BEAMS may be built with a 150 mm (6") long integral cable which is terminated with the appropriate QD connector. 	SM312FQDP

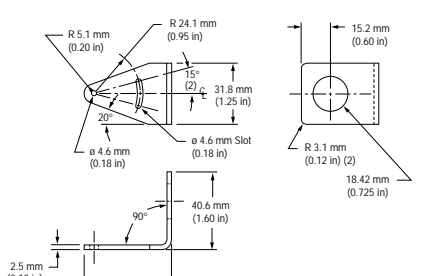
Extension Cables (without connectors)		
The following cables are available for extending the length of existing sensor cable. These are 30 m (100') lengths of MINI-BEAM cable. This cable may be spliced to existing cable. Connectors, if used, must be customer-supplied.		
Model	Type	Used with:
EC312-100	4-conductor	All MINI-BEAM SM312 dc models

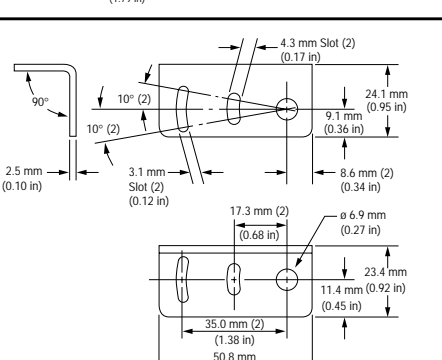
Euro-Style Quick-Disconnect Cables				
<b>Cable:</b> PVC jacket, polyurethane connector body, nickel-plated brass coupling nut <b>Conductors:</b> 22 or 20 AWG high-flex stranded, PVC insulation, gold-plated contacts <b>Temperature:</b> -40 to +90°C (-40 to +194°F) <b>Voltage Rating:</b> 250V ac/300V dc				
Style	Model	Length	Dimensions:	Pin-out
4-Pin Straight	MQDC-406 MQDC-415 MQDC-430	2 m (6.5') 5 m (15') 9 m (30')		
4-Pin Right-angle	MQDC-406RA MQDC-415RA MQDC-430RA	2 m (6.5') 5 m (15') 9 m (30')		

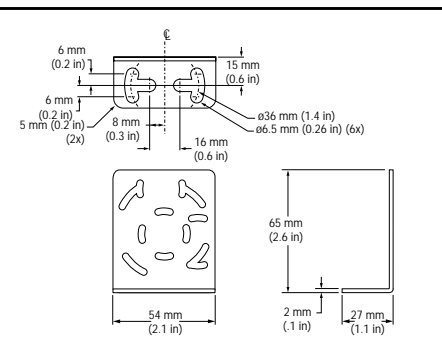
# MINI-BEAM® Sensors SM312F

Mounting Brackets			
Model	Description		
SMB312S	Stainless steel 2-axis, side mounting bracket		
SMB312PD	Stainless steel 18 mm barrel-mounting bracket		
SMB312B	Stainless steel 2-axis, bottom mounting bracket		
SMB46L	<ul style="list-style-type: none"> <li>• "L" bracket</li> <li>• 14 ga 316 stainless steel</li> </ul>		

Mounting Brackets			
Model	Description	Dimensions	
SMB46S	<ul style="list-style-type: none"> <li>• "S" bracket</li> <li>• 14 ga 316 stainless steel</li> </ul>	<p>Technical drawing of the SMB46S "S" bracket. Dimensions include: 10 mm (0.4 in), 6 mm (0.2 in), 6 mm (0.2 in), 5 mm (0.2 in), 8 mm (0.3 in), 16 mm (0.6 in), 34 mm (1.3 in), 17 mm (0.7 in), 3.5 mm (0.14 in), 15 mm (0.6 in), 54 mm (2.1 in), 65 mm (2.6 in), 2 mm (0.1 in), 27 mm (1.1 in), 16 mm (0.6 in). Hole diameters: <math>\phi 36</math> mm (1.4 in), <math>\phi 6.5</math> mm (0.26 in) (6x).</p>	
SMB46U	<ul style="list-style-type: none"> <li>• "U" bracket</li> <li>• 14 ga 316 stainless steel</li> </ul>	<p>Technical drawing of the SMB46U "U" bracket. Dimensions include: 17 mm (0.7 in), 13 mm (0.5 in), 6 mm (0.2 in), 6 mm (0.2 in), 5 mm (0.2 in), 8 mm (0.3 in), 16 mm (0.6 in), 34 mm (1.3 in), 17 mm (0.7 in), 3.5 mm (0.14 in), 15 mm (0.6 in), 54 mm (2.1 in), 65 mm (2.6 in), 2 mm (0.1 in), 27 mm (1.1 in), 70 mm (2.8 in), 16 mm (0.6 in). Hole diameters: <math>\phi 36</math> mm (1.4 in), <math>\phi 6.5</math> mm (0.26 in) (6x).</p>	
SMB18C	<ul style="list-style-type: none"> <li>• 18 mm split clamp black thermoplastic polyester bracket</li> <li>• Stainless steel mounting hardware included</li> </ul>	<p>Technical drawing of the SMB18C split clamp bracket. Dimensions include: 40.0 mm (1.60 in), 42.4 mm (1.67 in), 14.0 mm (0.55 in), 30.0 mm (1.18 in), 21.1 mm (0.83 in), 2.5 mm (0.10 in), 13 mm (0.5 in). Hardware: Nut Plate, M5 x 0.8 x 60 mm Screw (2).</p>	
SMB18SF	<ul style="list-style-type: none"> <li>• 18 mm swivel bracket</li> <li>• Black thermoplastic polyester</li> <li>• Includes stainless steel swivel locking hardware</li> </ul>	<p>Technical drawing of the SMB18SF swivel bracket. Dimensions include: 36.0 mm (1.42"), 42.0 mm (1.65"), 50.8 mm (2.00"), 10.6 mm (0.42"), 22.9 mm (0.9"), 25.4 mm (1.00"). Hardware: M18 x 1 internal thread.</p>	