



Q45BB6LL Series – Laser Diode Retroreflective Sensors†

Very-Long-Range Retroreflective Sensors for 10 to 30V dc

Features



- High power and small effective beam for retroreflective sensing applications
- Class II laser diode light source; operates from 10 to 30V dc
- 40 m (130') range for polarized models and 70 m (225') range for non-polarized models, using supplied BRT-2x2 target
- Bipolar NPN (sinking) and PNP (sourcing) solid-state outputs, switchable light and dark operate; 250 mA maximum load
- Top mounted Power, Signal (AID™ System), and Output indicator LEDs
- Optional plug-in Pulse or Delay timing logic and display modules
- Designed to withstand 1200 psi washdown; exceeds its NEMA 6P and IEC IP67 rating

† U.S. Patent(s) issued or pending

Models

		Model	Cable*	Range	Supply Voltage	Output Type	Excess Gain
Non-Polarized	Visible red, 655 nm	Q45BB6LL Q45BB6LLQ Q45BB6LLQ6	5-wire 2 m (6.5') 5-Pin Mini-style QD 5-Pin Euro-style QD	0.3–70 m (1'–225') w/BRT-2x2 (included)	10 to 30V dc	Bipolar NPN/ PNP	
Polarized	Visible red, 655 nm	Q45BB6LLP Q45BB6LLPQ Q45BB6LLPQ6	5-wire 2 m (6.5') 5-Pin Mini-style QD 5-Pin Euro-style QD	0.6–40 m (2'–130') w/BRT-2x2 (included)	10 to 30V dc	Bipolar NPN/ PNP	

* 9 m cables are available by adding suffix "W/30" to the model number of any cabled sensor (e.g., Q45BB6LL W/30). A model with a QD connector requires a mating cable; see page 6.



WARNING . . . Not To Be Used for Personnel Protection

Never use these products as sensing devices for personnel protection. Doing so could lead to serious injury or death.

These sensors do NOT include the self-checking redundant circuitry necessary to allow their use in personnel safety applications. A sensor failure or malfunction can cause either an energized or de-energized sensor output condition. Consult your current Banner Safety Products catalog for safety products which meet OSHA, ANSI and IEC standards for personnel protection.

Q45BB6LL Series – Laser Retroreflective Sensors

Overview

Status indicator LEDs for Power, Signal and Output are clearly visible beneath a raised dome in the sensor's transparent o-ring-sealed polycarbonate cover. The Power indicator lights whenever power is applied to the sensor. The Signal LED lights whenever the sensor sees its modulated light source, and pulses at a rate proportional to the strength of the received light signal; this is the AID™ Alignment Indicating Device. The Output indicator lights whenever the sensor's output is conducting. This indicator is especially useful when a timing logic module is used and Signal and Output conditions are not concurrent.

Also located beneath the sensor's o-ring-sealed cover are controls for light/dark operate selection and Sensitivity (gain) adjustment.

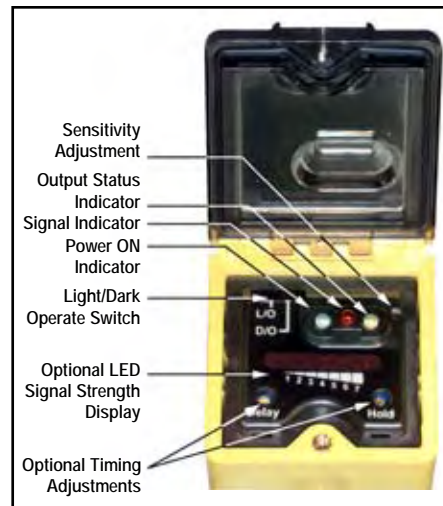

Figure 1. Sensor indicators and controls

Alignment

Conventional retroreflective photoelectric sensors are extremely easy to align. Beam angles are wide, and retro targets are forgiving to angle of incidence of the light beam. The beam of the Q45 laser sensor is very narrow, compared with the beam of most retro sensors. As Figure 2 indicates, the effect of angular misalignment can be dramatic. Alignment is critical because the beam may miss the retroreflective target unless the retro target is large.

For example, with one BRT-2x2 mounted at a distance of 6 m (20') from the sensor, one degree of angular misalignment will cause the center of the laser beam to miss the center of the target by 4 inches (i.e., the beam will miss the edge of the reflector by almost 3 inches).

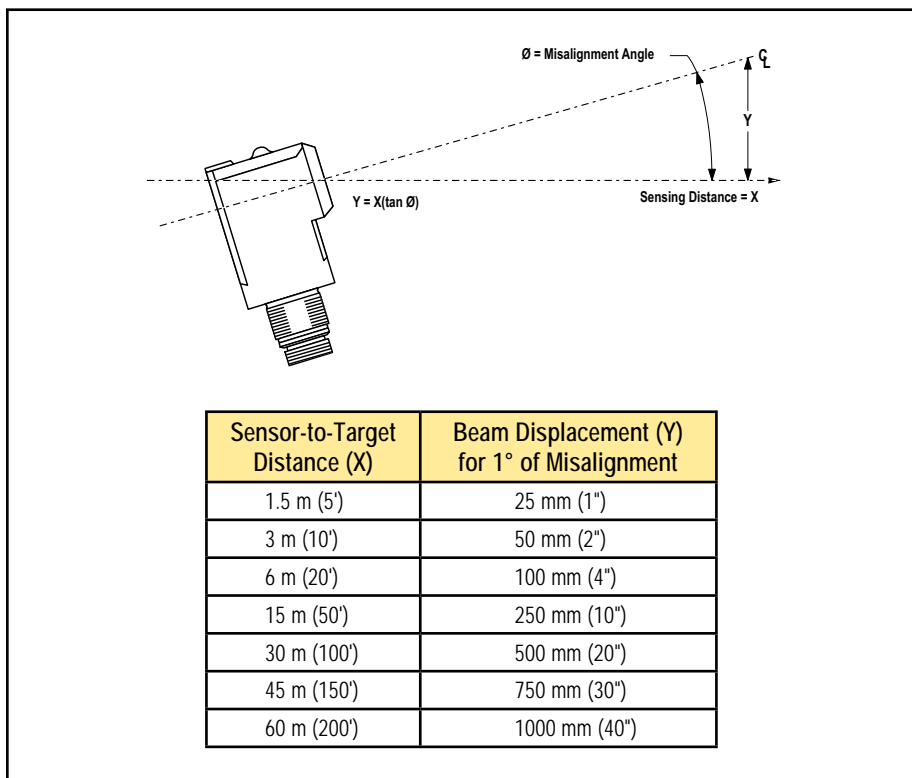

Figure 2. Beam displacement per degree of misalignment

Q45BB6LL Series – Laser Retroreflective Sensors



CAUTION . . .

Never stare directly into the sensor lens. Laser light can damage your eyes. Avoid placing any mirror-like object in the beam. Never use a mirror as a retroreflective target.



CAUTION . . .

This sensor contains no user-servicable components. Do not attempt to repair. Incorrect component values may produce hazardous laser radiation levels.

Alignment Tip

When using a small retroreflective target at medium or long range, temporarily attach (or suspend) a strip of retroreflective tape (e.g., BRT-THG-2) along a line which intersects the actual target. The visible red laser beam is easily seen in normal room lighting. Sight along the beam toward the target (from behind the sensor). Move the sensor to scan the laser beam back and forth across the retro tape strip. Use the tape strip to guide the beam onto the target.

Consider the use of Banner sensor mounting bracket SMB30SC (see page 7). This swivel bracket can simplify multiple-axis alignment. Alignment is complete when the visible image is centered on the retro target. The perpendicularity of the laser beam to the face of the retro target is forgiving, just as it is with a conventional retroreflective sensor.

Effective Beam Size

Unlike conventional retroreflective sensors, the retroreflective laser has the ability to sense relatively small profiles. Figure 3 indicates the diameter of the smallest opaque rod which will reliably break the laser beam at several sensor-to-object distances. These figures assume an excess gain of about 10X. Flooding effects are possible when the gain is much higher. This means that sensor gain may have to be reduced in some situations in order to reliably detect these minimum object sizes.

Note that the shape of the beam is elliptical. The minimum object sizes listed assume passage of the rod across the major diameter of the ellipse (worst case). It may be possible to detect objects smaller than the sizes listed if the direction in which the objects pass through the beam can be controlled.

Distance from Sensor to Object	Minimum Object Detection Size
0.3 m (1')	2.5 mm (0.10")
1.5 m (5')	3.0 mm (0.12")
3 m (10')	4.5 mm (0.18")
15 m (50')	19 mm (0.75")
30 m (100')	25 mm (1.0")

Figure 3. Minimum object detection size vs. distance from sensor

Q45BB6LL Series – Laser Retroreflective Sensors

Specifications

Supply Voltage and Current	10 to 30V dc (10% maximum ripple), at less than 50 mA (exclusive of load)
Supply Protection Circuitry	Protected against reverse polarity and transient voltages
Output Configuration	Bipolar: one current sourcing (PNP) and one current sinking (NPN) open-collector transistor
Output Rating	250 mA maximum each output up to 50° C, derated to 150 mA at 70° C (derate 5 mA/°C) Off-state leakage current: less than 1 microamp Output saturation voltage (both outputs): less than 1 volt at 10 mA and less than 2 volts at 250 mA
Output Protection Circuitry	Protected against false pulse on power-up and continuous overload or short circuit of outputs
Output Response Time	Less than 2 milliseconds NOTE: 1 second delay on power-up; outputs do not conduct during this time.
Repeatability	0.5 milliseconds; response time and repeatability specifications are independent of signal strength
Adjustments	Beneath sensor's transparent cover: Light/Dark Operate select switch and multi-turn Sensitivity control on top of sensor allow precise sensitivity setting (turn clockwise to increase gain). Optional logic and logic/display modules have adjustable timing functions (see page 6).
Indicators	Indicator LEDs are visible beneath a raised transparent polycarbonate dome on top of the sensor. Power (green) LED: lights whenever 10 to 30V dc power is applied, and flashes to indicate output overload or output short circuit. A steady green LED also indicates that laser light is being emitted. Signal (red) AID™ system LED: lights whenever the sensor sees its modulated light source, and pulses at a rate proportional to the strength of the received light signal Load (yellow) LED: lights whenever an output is conducting Optional 7-element LED: signal strength display module (see page 7)
Construction	Molded thermoplastic polyester housing, o-ring sealed transparent polycarbonate top cover, molded acrylic lenses, and stainless steel hardware. Q45 sensors are designed to withstand 1200 psi washdown. The base of cabled models has a 1/2" NPS integral internal conduit thread.
Environmental Rating	NEMA 6P, IEC IP67
Laser Classification	Class II laser product. US Safety Standards 21 CFR 1040.10 and 1040.11; European Standards EN 60825 and IEC 60825
Connections	PVC-jacketed 2 m (6.5') or 9 m (30') cables, or 5-pin Mini-style ("Q" suffix models) or 5-pin Euro-style ("Q6" suffix models) quick disconnect (QD) fitting are available. QD cables are ordered separately; see page 6.
Operating Conditions	Temperature: -10° to +40° C (+14° to 104° F) Maximum relative humidity: 90% at 50° C (non-condensing)
Application Notes	Optional logic timing modules are available. See page 7 for more information.
Certifications	

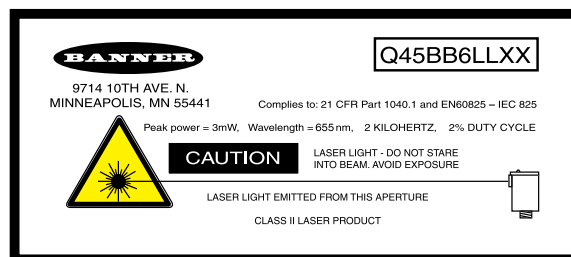

Q45BB6LL Series – Laser Retroreflective Sensors

Dimensions

Cabled Models

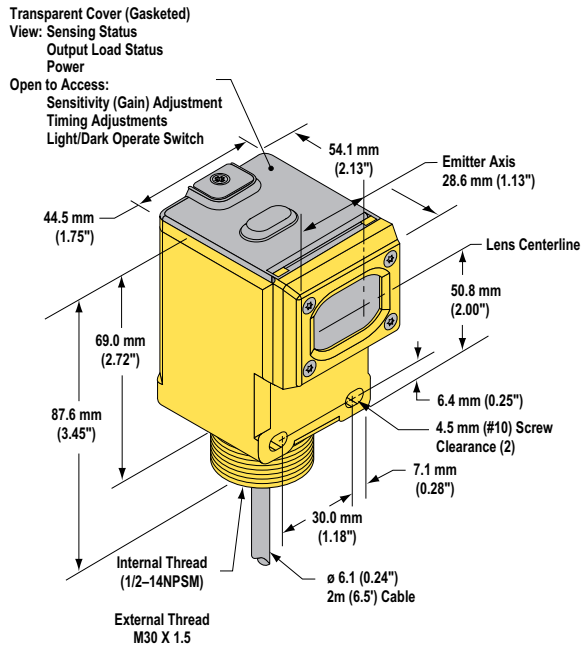

5-Pin Mini-Style Quick-Disconnect Models

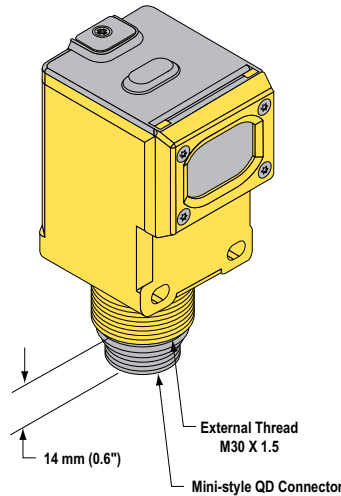

5-Pin Euro-Style Quick-Disconnect Models

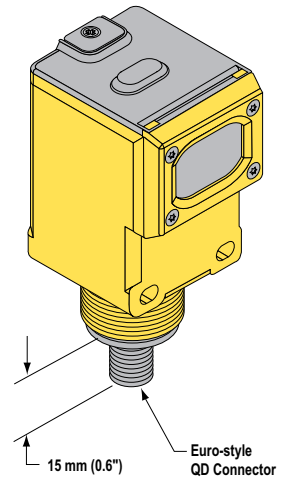

Hookups

Cabled Models

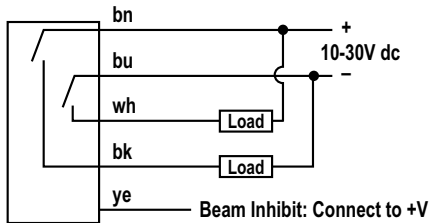

Mini- or Euro-Style Quick-Disconnect Models

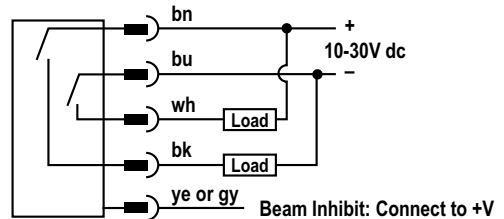

Q45BB6LL Series – Laser Retroreflective Sensors

Accessories

Quick-Disconnect (QD) Cables

Cable: PVC jacket; polyurethane connector body; nylon coupling nut (Mini), chrome-plated brass coupling nut (Euro)
Conductors: 18 AWG (Mini), 22 or 20 AWG (Euro) high-flex stranded, PVC insulation, gold plated contacts
Temperature: -40° to +80° C (-40° to +176° F) (Mini); -40° to +90° (-40° to +194° F) (Euro)
Voltage Rating: 250V ac/300V dc

Style	Model	Length	Dimensions	Pinout
5-Pin Euro-Style Straight	MQDC1-506 MQDC1-515 MQDC1-530	2 m (6.5') 5 m (15') 9 m (30')		
5-Pin Mini-Style Straight	MBCC-506 MBCC-512 MBCC-530	2 m (6.5') 4 m (12') 9 m (30')		

Contact factory for right-angle connectors.

Retroreflective Targets

Banner offers a wide selection of high-quality retroreflective targets. See the Accessories section of your current Banner Photoelectric Sensors catalog for complete information.

NOTE: Polarized sensors require corner cube type retroreflective targets only. Non-polarized sensors may use any retroreflective target.

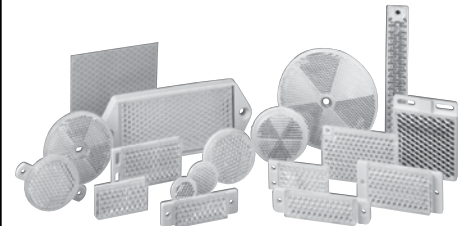

Q45BB6LL Series – Laser Retroreflective Sensors







Accessories, continued

Output Timing Logic and Signal Strength Display Modules

Q45 sensors easily accept the addition of output timing logic and signal strength display functions. Display modules have a seven-element display which gives a more precise indication of excess gain than does the AID™ system LED that is standard on Q45 sensors. The modules listed below may be used with all Q45BB6 Series sensors. See the data sheet packed with the module for more information.

Model	Logic and/or Display Function	
45LM58	Programmable output timing logic	
45LM58D	Programmable output timing logic plus signal strength display	
45LMD	Signal strength display only (no timing function)	

Mounting Brackets

SMB30A <ul style="list-style-type: none"> • Right-angle mounting bracket with curved slot for versatile orientation • 12-ga. stainless steel • Clearance for M6 (1/4") hardware 		SMB30UR <ul style="list-style-type: none"> • 2-piece universal swivel bracket for limit-switch style sensors • 300 series stainless steel • Includes stainless steel swivel locking hardware 	
SMB30MM <ul style="list-style-type: none"> • 30 mm bracket with curved mounting slots for versatile orientation • 12-ga. stainless steel • Clearance for M6 (1/4") hardware 		SMBAMS30P <ul style="list-style-type: none"> • Flat SMBAMS series bracket with 30 mm hole for mounting sensors • 12-ga. 300 series stainless steel • Articulation slots for 90+° of rotation 	
SMB30Q <ul style="list-style-type: none"> • 30 mm right-angle flanged mounting bracket • Stainless steel 		SMBAMS30RA <ul style="list-style-type: none"> • Right-angle SMBAMS series bracket with 30 mm hole for mounting sensors • 12-ga. 300 series stainless steel • Articulation slots for 90+° of rotation 	
SMB30SC <ul style="list-style-type: none"> • 30 mm swivel bracket • Black reinforced thermoplastic polyester • Includes stainless steel mounting and swivel locking hardware 	