



QC50 Series True Color Sensor

Compact, self-contained, three-output color-differentiating sensor

Features



- Two versions for application flexibility: QC50 models for most applications, and QCX50 models for more challenging applications
- Compact, self-contained design
- Analyzes and compares color to color, or varying intensities of one color
- QCX50 models excel in challenging applications, such as differentiating dark blue from black
- Fast sensing response time –
 - QC50 models:** 335 microseconds
 - QCX50 models:** 5 ms (reduced resolution setting – 1 ms)
- Easy-to-set programming options for 1, 2, or 3 colors
- Three programming parameters: channel, sensing mode, and tolerance level
- 10 tolerance levels to allow for product variation
- Output OFF-delay (6 options); selection applies to all three color channels
- Gate mode option (also called inhibiting, synchronization or windowing)

Models

Models	Sensing Range	Cable/Connector*	Sensing Response Time	Supply Voltage	Output Type
QC50A3P6XDWQ	20 mm (0.8") typical; varies according to sensor configuration	8-pin Euro-style (M12) swivel QD connector	335 μ s	10 to 30V dc	PNP, 3 channels
QC50A3N6XDWQ					NPN, 3 channels
QCX50A3P6XDWQ			Selectable 5 ms or 1 ms		PNP, 3 channels
QCX50A3N6XDWQ					NPN, 3 channels

* Mating cable required; see page 7 for cable options



WARNING . . . Not To Be Used for Personnel Protection

Never use these products as sensing devices for personnel protection. Doing so could lead to serious injury or death.

These sensors do NOT include the self-checking redundant circuitry necessary to allow their use in personnel safety applications. A sensor failure or malfunction can cause either an energized or de-energized sensor output condition. Consult your current Banner Safety Products catalog for safety products which meet OSHA, ANSI and IEC standards for personnel protection.

QC50 Series True Color Sensor

Overview

The easy-to-use QC50 series true color sensor uses modulated white light with red, green, and blue (R, G, B) electronic filters to scan for the presence of one, two or three colors. Its compact size allows it to be mounted almost anywhere. Configuration options include Programming mode for color detection parameters and Setup mode for selecting an adjustable output OFF-delay or selecting between two response speeds (some models). Three solid-state outputs may be set individually for color differentiation or for color-plus-intensity differentiation (see Sensing Modes below).

The sensor has two push buttons, Set and Select, plus a 4-digit LED display, an Output LED, and three Output Status LEDs (one for each sensing output), for easy programming and status monitoring during operation. Push buttons can be locked out for security (see page 5).

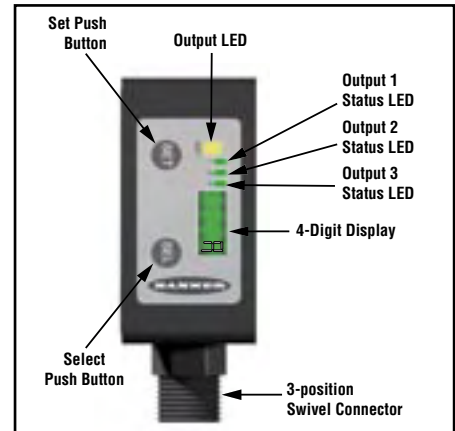

Figure 1. Sensor features

Sensor Configuration

Outputs

The QC50 can be programmed to sense one, two, or three colors. Three outputs are available for this purpose. When a programmed color is sensed, the yellow Output (“OUT”) indicator LED and the associated green Output Status LED turn ON, and the respective output conducts.

Sensing Modes

The Sensor functions in one of two sensing modes: Color only (expressed “C” on the 4-digit display) or Color-Plus-Intensity (expressed “C_I”). In Color sensing mode, only colors are sensed. This is most useful for sorting obvious color differences (for example, red or black or green).

The Color-Plus-Intensity option refines the sensor’s capabilities to include grayscale as well, broadening the spectrum of colors and shades which the sensor can be programmed to detect. This feature allows “batch” sorting or identifying within a color family (for example, light blue or medium blue or dark blue).

Tolerance Levels

The Sensor can be configured for one of 10 levels of tolerance (0 to 9). A higher number (for example 9, expressed “toL9” on the 4-digit display) permits the sensor to accept a wider range of target conditions, compared with lower tolerance levels. A tolerance level of 0 (expressed “toL0”) causes much more precise discrimination and a narrower range of target conditions.

OFF-Delay

An output OFF-delay value up to 40 milliseconds may be set (see page 5). This value represents the time interval, following termination of sensing, during which the outputs remain active (see Figure 3). NOTE: The selected delay will apply to all three outputs.

Sensing Response Speed

The QCX50 models feature two selectable sensing response speeds: Normal and Fast. At either speed, sensing resolution is improved over that of the QC50 models. The faster the speed, the lower the resolution. Normal speed is the recommended mode for most applications and provides the best resolution. Normal speed enables such high-resolution sensing as differentiating between similar shades of beige.

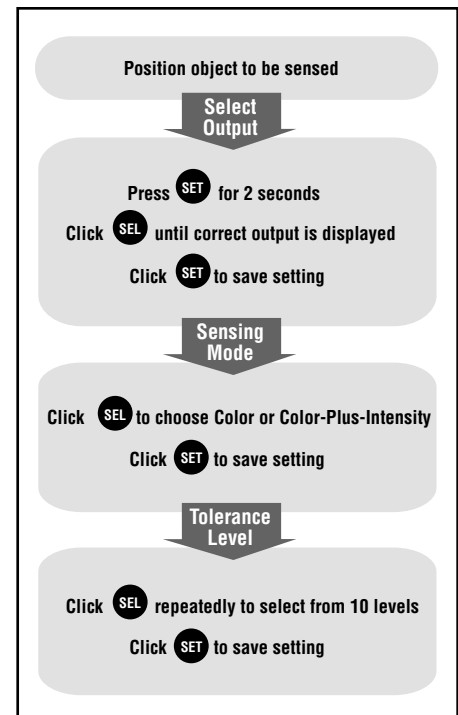

Figure 2. A quick sensor programming guide

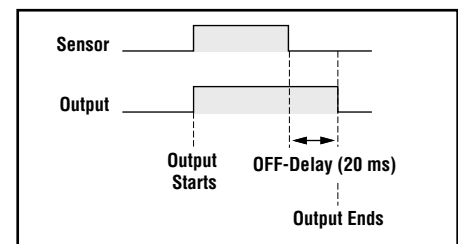



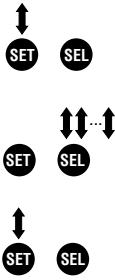

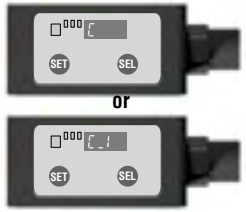

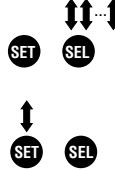

Figure 3. 20 ms OFF-delay (d_20): output continues for an interval after sensing stops (applies to all outputs)

QC50 Series True Color Sensor

Sensor Programming

Programming mode determines the colors the sensor will detect for each of the three outputs. Repeat the following steps for each output. Refer to Figure 2 for a quick overview of this process. The procedure is identical for all models.

NOTE: The sensor has a 12-second time-out. If a period longer than 12 seconds elapses between steps, sensor will return to Run mode without saving settings.

	Procedure	LED Display
Sample Color	<p>Position new color to be sensed within scanning distance, typically 20 mm (0.8"); sensor will sample the color to be sensed*</p>	<p>Output LED: OFF Output Status LEDs: All OFF Display: run (no OFF-delay) or rund (OFF-delay selected)</p> 
Select Channel	<ul style="list-style-type: none"> Press and hold Set ≥ 2 seconds Channel 1 ("SET1") is selected by default Click Select repeatedly until desired channel is displayed Click Set to save selection 	<p>Output LED: OFF Output Status LEDs: All OFF Display: SET1 (channel 1) or SET2 (channel 2) or SET3 (channel 3)</p> 
Sensing Mode	<ul style="list-style-type: none"> Click Select to choose: <i>Color</i> or <i>Color + Intensity</i> (Color is the default mode) Click Set to save selection 	<p>Output LED: OFF Output Status LEDs: All OFF Display: C (Color) or C_I (Color + Intensity)</p> 
	<ul style="list-style-type: none"> Sensor saves color settings** 	<p>Output LED: ON (if saved) Output Status LEDs: Selected channel ON Display: uPdt (flashing 2 seconds)</p> 
Tolerance Level	<ul style="list-style-type: none"> Click Select repeatedly until desired tolerance level is displayed; 10 levels available Click Set to save tolerance setting** 	<p>Output LED: ON Output Status LEDs: Selected channel ON Display: toL0 (most selective) toL1 (tolerance level 1) ↓ toL9 (least selective)</p> 

*If the color being taught is out of the sensor's range, a "FAIL" message will appear in the 4-digit display, followed by a "Hi" or "Lo" message (indicating too much or too little light, respectively).

****Remembering Settings:** Save selected sensor settings by clicking the Set push button at the end of Programming mode. The settings are saved in the sensor's "EEPROM" memory and the sensor remembers the current settings, even after being powered off.

QC50 Series True Color Sensor

Indicator Displays

To review the sensor's settings, press Select for 2 seconds or more. The output channel, sensing mode, and tolerance level will then be displayed sequentially (see Figure 4), followed by the delay interval (applicable to all channels) and normal or fast mode (for QCX50 models). At the end of the sequence, the display will indicate "run" or "rund" (depending on the delay setting).

Non-Initialization Display Messages

When using a sensor for the first time, the message "E2Pr" may be displayed (see Figure 5). This indicates the memory has yet to be used. To correct this situation, set up a channel according to the procedure described earlier in "Programming Mode." When any channel is set up successfully, a "run" or "rund" message is displayed.

Run Mode

Normal sensor operation is called Run mode. The LED indicators and the 4-digit display indicate current operating status. For example, if the color sensor is detecting the color for which output 1 is programmed and no delay is selected, the indicators will appear:

Output ("Out") LED: ON Yellow
Output 1 Status LED: ON Green
4-digit display: run

Fast Mode

When a QCX50 model sensor is operating in Fast mode, the display will flash "FAST" for approximately 5 seconds of every 40 seconds.

Application Notes

Using the Gating Function

The output function of the sensor's color detection can be gated using the sensor's red wire (see hookups, page 7). Using this function controls the sensor's output and permits output to occur only when "signaled" by the use of the red wire. This output control feature is most useful when multiple repeats of a color could occur, such as with registration marks in a margin, yet only one point on the work is needed for an accurate determination. Gating is also known as triggering, windowing, inhibiting, or synchronization.

In the sensor's normal operating state (output enabled, red wire open or low), the sensor responds to all taught colors (the Output LED, Channel Status LEDs, and all outputs respond to target conditions). When the red wire is held high (output disabled, red wire at high supply potential), the sensor does not respond to the taught colors (LEDs do not light and outputs do not conduct; i.e., inhibit).

Push Button Disable

It is possible to lock out the push buttons to prevent accidental or unauthorized adjustments on the production floor. See page 5 for the procedure.

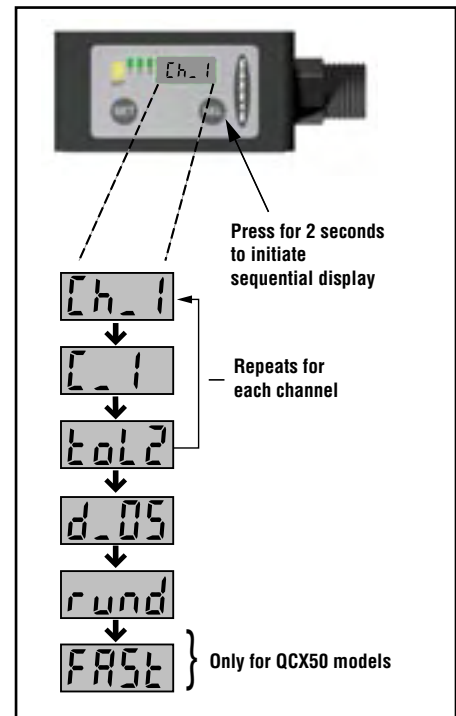



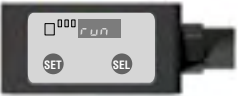





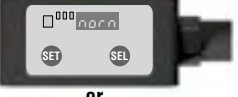



Figure 4. Sequential display of setting

QC50 Series True Color Sensor

Sensor Setup		
OFF-Delay: Used only for applications that require an OFF-delay (see page 2). Choose from 5 delay options, or no delay.		
Set Output OFF-Delay	Procedure <ul style="list-style-type: none"> Press Set ≥ 6 seconds Click Select repeatedly until desired delay setting is displayed (d_00 to d_40)  	Result Output LED: OFF (no target) Channel Status LEDs: All OFF Display: d_00 (no delay) d_05 (5 ms delay) d_10 (10 ms delay) d_20 (20 ms delay) d_30 (30 ms delay) d_40 (40 ms delay) 
	<ul style="list-style-type: none"> Click Set to store settings 	Result Output LED: OFF (no target) Channel Status LEDs: All OFF Display: run (no delay selected) or rund (delay selected)  <p style="text-align: center;">or</p> 
Sensing Response Speed: Selectable only for QCX50 models.		
Access Selection Mode	<ul style="list-style-type: none"> Press and hold Set and Select together ≥ 2 seconds 	<ul style="list-style-type: none"> Current selection is displayed Display: norm (normal) or FAST  <p style="text-align: center;">or</p> 
	<ul style="list-style-type: none"> Click Select to toggle between fast or normal speeds Press Set > 2 seconds or wait 20 seconds for sensor to time out and return to Run mode with new settings  	<ul style="list-style-type: none"> New selection is displayed Display: norm (normal) or FAST  <p style="text-align: center;">or</p> 
Push Button Lockout: For security, the push buttons may be disabled.		
Connect Gate Switch	<ul style="list-style-type: none"> Connect a switch between Gate input and +10-30V dc 	Sensor is ready for keypad to be enabled or disabled.
	<ul style="list-style-type: none"> Close Gate switch and power up sensor 	Sensor push buttons are disabled.
	<ul style="list-style-type: none"> Open Gate switch and power up sensor 	Sensor push buttons are enabled.

QC50 Series True Color Sensor

Installing the Color Sensor

NOTE: When sensing glossy surfaces, install the sensor at approximately a 15° angle with respect to the target. See Figure 5.

1. Determine the best position for the swivel connector (back, side, or bottom of the sensor).
2. Measure the appropriate operating distance from the front surface of the sensor optics to the point where the sensor is to be fastened. Typically, the ideal distance is 20 mm (0.8").
3. Fasten the sensor to its intended location using two screws (M4x35 or longer). Any two of three holes in the housing may be used for this purpose.
4. Attach the power cable to the sensor's connector; see hookups on page 7.

NOTE: When the sensor is ON, the white emitter beam is ON and a message ("run" or "rund") appears on the 4-digit status display.

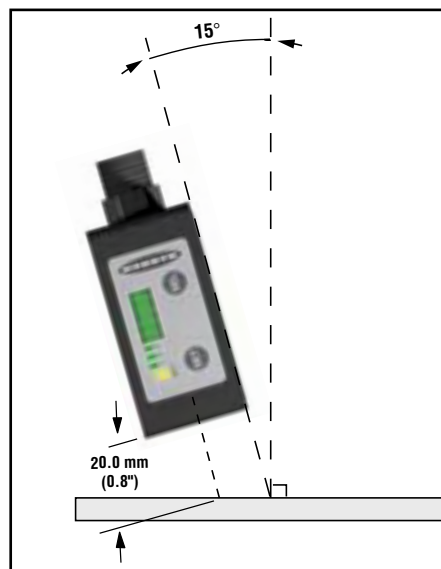



Figure 5. Mount sensor 15° from perpendicular when sensing a glossy surface

Specifications

Sensing Beam	Pulsed white LED (400 to 700 nm)
Sensing Receiver	Solid-state photodiode device with R, G, B filters
Sensing Range	20 mm (0.8") typical; varies depending on sensor configuration
Supply Voltage	10 to 30V dc, 2 V pp max ripple 40 mA max @ 24V dc (excluding output current)
Supply Protection Circuitry	Protected against reverse polarity, over-voltage, and transient voltage
Output Configuration	3 PNP or 3 NPN outputs, depending on model 30V dc max Saturation Voltage: < 2V
Output Rating	100 mA maximum load per output channel
Output Protection	Protected against output short-circuit, continuous overload, transient over-voltages, and false pulse on power up
Output Response Time	QC50 models: 335 microseconds QCX50 models: Selectable 5 ms (normal) or 1 ms NOTE: 500 ms delay at power-up; outputs do not conduct during this time. QC50 models Gate ON-time: 335 microseconds Gate OFF-time: 170 microseconds QCX50 models Gate ON-time: 700 microseconds Gate OFF-time: 400 microseconds
Adjustments	2 push buttons (Set and Select) • Color scanning, color mode, delay and tolerance • Manual adjustment of color channels, sensing mode and tolerance level
Indicators	4-Digit LCD Display: indicates sensing mode, display information, tolerance level, channel status Yellow Output LED: ON when any output is conducting 3 Green Channel Output Status LEDs: ON when its corresponding channel output is conducting
Construction	ABS shock-resistant housing; glass window and lens
Environmental Rating	IEC IP62

QC50 Series True Color Sensor

Specifications, continued

Connections	8-pin Euro-style (M12) swivel quick-disconnect fitting; 2 m (6.5'), 5 m (15') or 9 m (30') cable available separately. See page 7.
Operating Conditions	Temperature: -10° to +55°C (+14° to 131°F) Max. Relative Humidity: 90% at 50°C (non-condensing)
Data Retention	EEPROM nonvolatile memory
Minimum Spot Diameter	4 mm (0.2")
Ambient Light Rejection	According to EN 609475-2
Shock Resistance	Approx. 30 G; 3 shocks per axis; 11 ms duration
Vibration	0.5 mm (0.02") amplitude; 10 to 60 Hz frequency; 30 minutes for each X, Y, Z axis
Certifications	

Dimensions

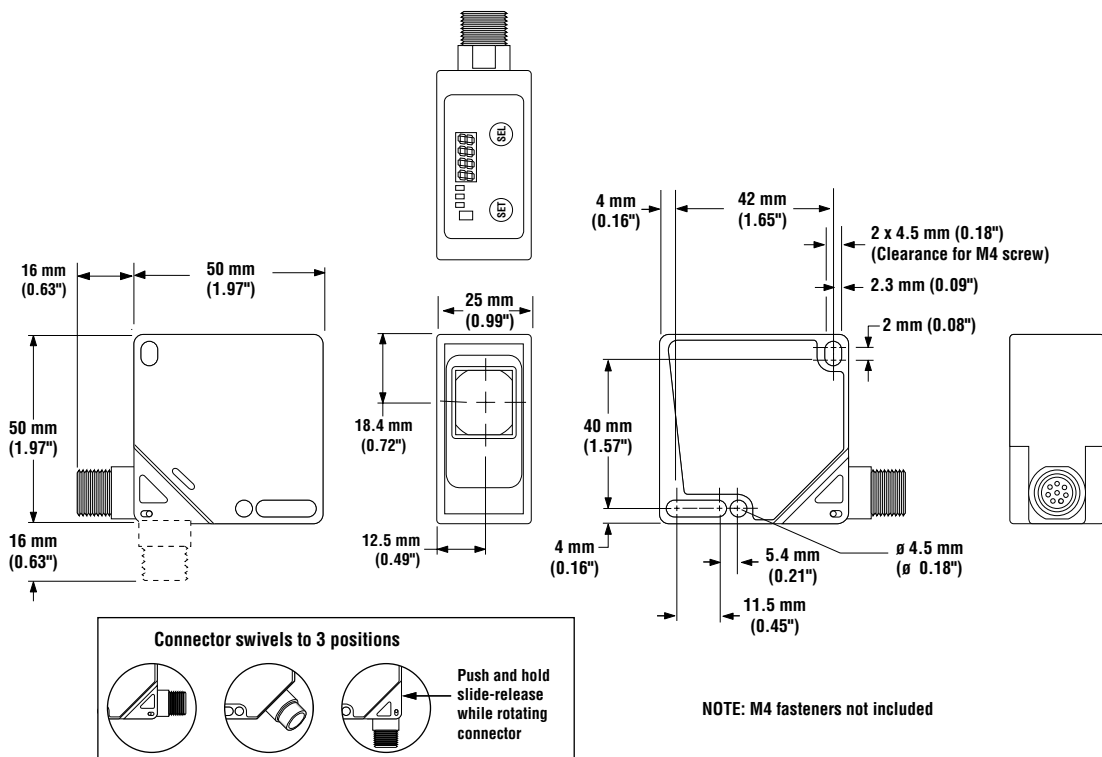

QC50 Series True Color Sensor

Hookups

PNP Hookup

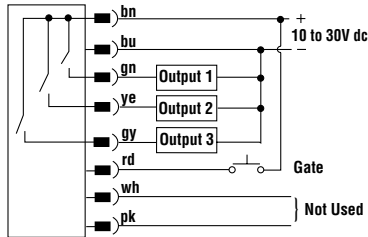

NPN Hookup

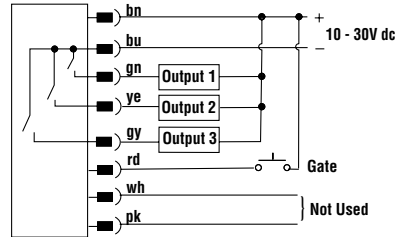

Quick-Disconnect Cables

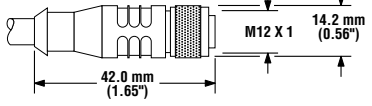
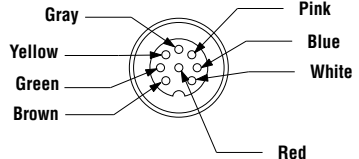
Style	Model	Length	Dimensions	Pin-Out
8-pin Euro-style (M12), straight connector with open shield	MQDC2S-806 MQDC2S-815 MQDC2S-830	2 m (6.5') 5 m (15') 9 m (30')		

Mounting Bracket

SMBQC50

- Multi-directional stainless steel L-bracket
- Provides a variety of mounting options

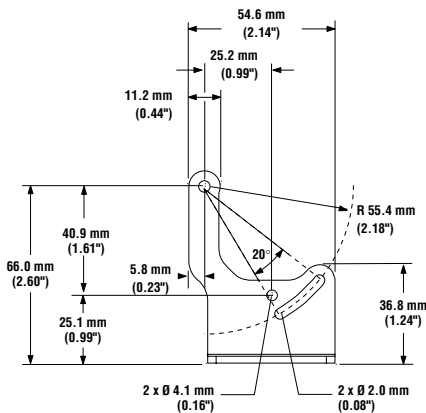

M4 SS Hardware included:
2 Screws
2 Flat Washers
2 Lock Washers
2 Nuts

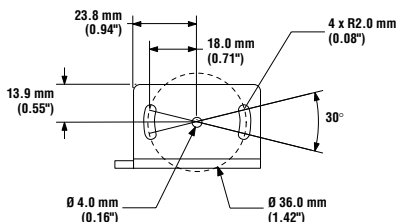
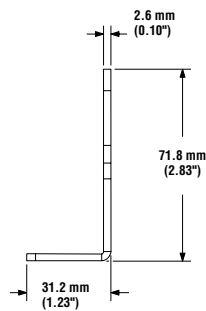

BANNER[®]
more sensors, more solutions

WARRANTY: Banner Engineering Corp. warrants its products to be free from defects for one year. Banner Engineering Corp. will repair or replace, free of charge, any product of its manufacture found to be defective at the time it is returned to the factory during the warranty period. This warranty does not cover damage or liability for the improper application of Banner products. This warranty is in lieu of any other warranty either expressed or implied.