



## QL50 Luminescence Sensor

*Compact, self-contained luminescence sensor*

### Features



- Compact, self-contained design
- Senses luminescent marks, even on luminescent backgrounds and on reflective surfaces, such as ceramic, metal, or mirrored glass
- Easy-to-set programming options for sensing precision and fine detection
- Low cost
- 2 indicator LEDs show operating and output status
- Fast 250 microsecond sensing response time
- NPN or PNP discrete output, depending on model
- Output OFF-delay option for longer ON condition
- 3-position swivel QD connector

### Models

Model	Cable/Connector*	Supply Voltage	Output type	Sensing Range
QL50AP6XD20BQ	4-pin Euro-style (M12) QD connector with 3-position swivel	10 to 30V dc	PNP	0 to 40 mm (0 to 1.57")
QL50AN6XD20BQ			NPN	

\* Mating cable required; see page 8 for cable options.



#### **WARNING . . . Not To Be Used for Personnel Protection**

**Never use these products as sensing devices for personnel protection. Doing so could lead to serious injury or death.**

These sensors do NOT include the self-checking redundant circuitry necessary to allow their use in personnel safety applications. A sensor failure or malfunction can cause either an energized or de-energized sensor output condition. Consult your current Banner Safety Products catalog for safety products which meet OSHA, ANSI and IEC standards for personnel protection.

# QL50 Luminescence Sensor

## Overview

The QL50 Series Sensor is an easy-to-use, compact luminescence sensor that emits ultraviolet light from an LED and scans for luminescence in materials. The QL50 senses luminescence that is inherent in a material, or it can sense luminophores that have been added to a material in process to make it luminescent.

The sensor's compact size allows it to be mounted almost anywhere. Configuration options include teachable sensing precision and fine-detection programming for accurate sensing of a wide range of luminescence intensities and background conditions.

The QL50 is available with either NPN or PNP output. The sensor has one push button for easy programming. Two LEDs provide power, error, and output information for easy monitoring during operation. See Figure 1.

### Luminescence Sensing

Luminescence sensing detects a form of electromagnetic radiation, caused by the shining of UV light ("black" light, invisible to the human eye) on a luminescent substrate material, such as an adhesive. When the UV light shines on the adhesive, the light "excites" electrons in the material (effecting a change of state), causing it to reflect visible light. Thus an invisible light source can produce a visible reflection. Because it emits UV light but detects visible waves, the sensor can distinguish between the fluorescent material and other highly reflective materials.

### Cost Factors

When comparing luminescence sensors to make a selection, it is important to consider whether luminophores must be added to the product sensed, in order for the sensor to detect luminescence. Generally speaking, the more sensitive the sensor, the lower the level of luminescence required for detection. Less sensitive (and usually less expensive) sensors may require an additional step in the production process, and a substantial cost over time, to add luminophores. For information on additional, more sensitive luminescence sensor models, refer to data sheet p/n 112153, Model QL55 Luminescence Sensor, or contact a Banner applications engineer for more information.

## Sensor Programming

The QL50 Sensor is pre-set to power up in RUN mode and sense a luminescent target. Applications with varying degrees of luminescence or with background luminescence may require additional programming:

- The Quick-Set procedure programs the sensor to detect a luminescence intensity brighter than the background (see page 3).
- The Fine-Detect procedure increases sensing precision and programs the sensor to detect a luminescence intensity that is either more or less luminescent than the background (see page 4).

### Programming Errors

If a programming error occurs, the bicolor Power LED flashes red and green. To correct a programming error, reset the sensor to the factory settings as follows:

1. Remove all luminescent objects from the sensing range.
2. Press and hold the push button (approx. 2 sec.) until the green Power LED turns OFF.

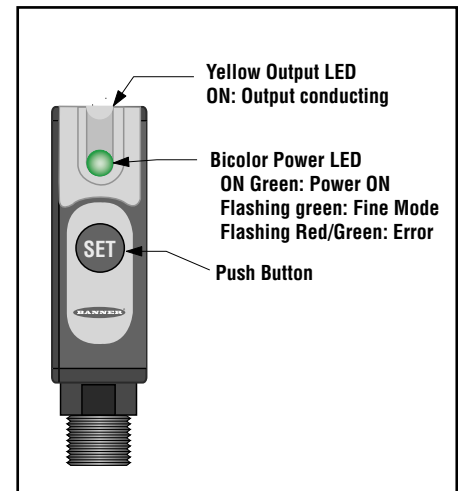

Figure 1. QL50 Luminescence Sensor features

## Remote Programming and Push-Button Lockout

The remote line allows programming with a remote switch. It can also be used to lock out the push button, preventing unwanted tampering with the push button. Connect the white remote wire to 0V if not used.

- To disable the push button and the remote program wire, connect the white remote wire to high supply potential (+V dc), then power the sensor ON.
- To program the sensor using the remote line, connect a normally open (N.O.) switch between the white remote wire and high supply potential (+V dc), then power the sensor ON. This enables remote programming.
- To enable the push button, turn the sensor power OFF, remove the white wire from high supply, and then turn sensor power ON.

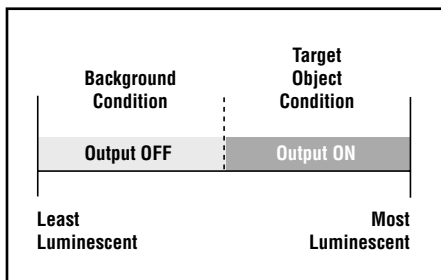







Figure 2. Quick-Set programming

## Quick-Set Programming

Quick-Set programming teaches the QL50 Sensor to respond to a specific luminescence intensity and ignore less-intense luminescence conditions. The programmed setting will be light operate; the sensor will respond to an equivalent or more luminescent condition.

Sensing the luminescent target will close the normally-open output, turn the yellow Output LED ON, and cause the output to conduct current (see Figure 2).

	Procedure		Result
	Push Button	Remote Line	
<b>Position Target</b>	<ul style="list-style-type: none"> <li>• Position luminescent target for sensing.</li> </ul>	<ul style="list-style-type: none"> <li>• Position luminescent target for sensing.</li> </ul>	<b>Yellow Output LED: ON (or OFF*)</b> <b>Green Power LED: ON (or OFF**)</b> 
<b>Program Sensor</b>	<ul style="list-style-type: none"> <li>• Press and hold push button (approx. 2 sec.) until green Power LED turns OFF, then release.</li> </ul> 	<ul style="list-style-type: none"> <li>• Hold remote line (white wire) high (approx. 2 sec.) until green Power LED turns OFF, then release.</li> </ul> 	<b>Yellow Output LED: OFF, then ON</b> <b>Green Power LED: OFF, then ON</b> Sensor returns to RUN mode  

\*The Yellow LED may be ON or OFF, depending on target and range.

\*\*The Green LED may go OFF if a target is presented at the sensor threshold.

# QL50 Luminescence Sensor

## Fine-Detection Programming

Fine-Detection programming teaches the QL50 Sensor to respond to a more precise specific luminescence intensity and ignore surfaces with either less intense or more intense luminescence. Fine-Detection programming compares target luminescence to background luminescence and automatically selects light operate or dark operate.

**Light Operate:** detects a target that is more luminescent than the background. Sensing the more luminescent target will close the normally-open output, turn on the yellow LED, and cause the output to conduct current (see Figure 3).

**Dark Operate:** detects a target that is less luminescent than the background. Sensing the less luminescent target will close the normally-open output, turn on the yellow LED, and cause the output to conduct current (see Figure 3).

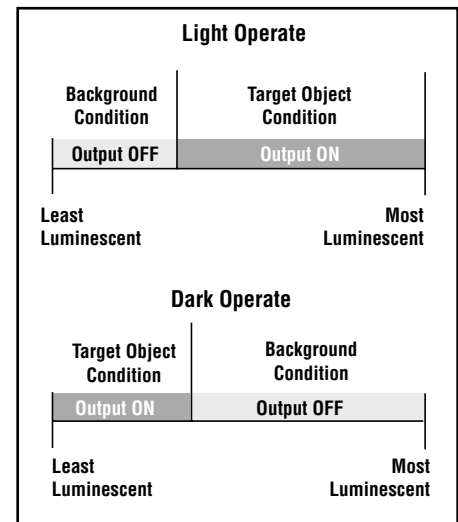











Figure 3. Fine-Detection Programming

	Procedure		Result**
	Push Button	Remote Line	
<b>Position Target</b>	<ul style="list-style-type: none"> <li>Position luminescent target for sensing.</li> </ul>	<ul style="list-style-type: none"> <li>Position luminescent target for sensing.</li> </ul>	<p><b>Yellow Output LED:</b> ON (Light Operate), or OFF (Dark Operate)  <b>Green Power LED:</b> ON</p>  
<b>Program Target-Present Condition</b>	<ul style="list-style-type: none"> <li>Press and hold push button (approx. 4 sec.) until Power LED turns OFF and begins to flash green.</li> <li>Perform next two steps within 35 seconds.*</li> </ul> 	<ul style="list-style-type: none"> <li>Hold remote line (white wire) high (approx. 4 sec.) until Power LED turns OFF and then begins to flash green.</li> <li>Perform next two steps within 35 seconds.*</li> </ul> 	<p><b>Yellow Output LED:</b> OFF  <b>Green Power LED:</b> OFF, then Flashing</p>  
<b>Remove Target</b>	<ul style="list-style-type: none"> <li>Remove luminescent target.</li> </ul>	<ul style="list-style-type: none"> <li>Remove luminescent target.</li> </ul>	<p><b>Yellow Output LED:</b> OFF  <b>Green Power LED:</b> Flashing</p> 
<b>Program Target-Absent Condition</b>	<ul style="list-style-type: none"> <li>Press and hold push button (approx. 4 sec.) until Power LED turns ON.</li> </ul> 	<ul style="list-style-type: none"> <li>Hold remote line high (approx. 4 sec.) until Power LED turns ON green.</li> </ul> 	<p><b>Yellow Output LED:</b> OFF (no target)  <b>Green Power LED:</b> ON</p> <p>Sensor returns to RUN mode.</p> 

\*Sensor has a 35-second time-out. If a 35-second interval elapses between steps, the sensor returns to RUN mode without saving new values.

\*\*Green LED brightness may diminish during poor signal conditions (near transition areas).

# QL50 Luminescence Sensor

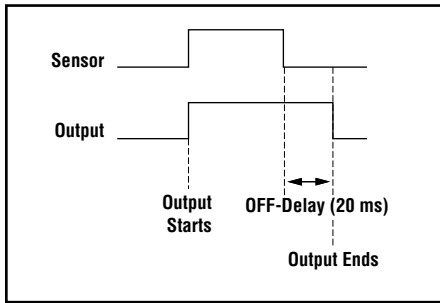

Figure 4. OFF-delay: output continues for 20 ms after sensing stops

## Sensor Setup









### Output OFF-Delay Option

This setup procedure toggles the delay status between active and inactive status.

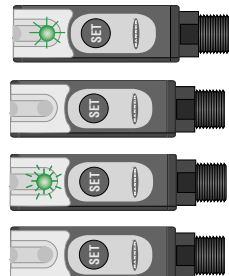
Setting an output OFF-delay extends the duration of the sensor's ON output by 20 ms. See Figure 4.

The sensor will retain the most recent delay setting if a loss of power occurs.

NOTE: The QL50 Sensor is factory-set to power up without an output OFF-delay.

	Procedure		Result
	Push Button	Remote Line	
<b>Access SETUP Mode</b>	<ul style="list-style-type: none"> <li>Press and hold push button (approx. 10 sec.) until Power LED turns OFF, then flashes green, then stays OFF.*</li> </ul> 	<ul style="list-style-type: none"> <li>Hold remote line (white wire) high (approx. 10 sec.) until Power LED turns OFF, then flashes green, then stays OFF. Open remote line.*</li> </ul> 	<p><b>Yellow Output LED:</b> OFF (no target)  <b>Green Power LED:</b> ON 1 second, then OFF 1 second, then Flashing 8 seconds, then OFF</p> 
<b>Delay Status</b>	<ul style="list-style-type: none"> <li>Watch for Power LED to flash green to indicate Delay status.</li> </ul>	<ul style="list-style-type: none"> <li>Watch for Power LED to flash green to indicate Delay status.</li> </ul>	<p><b>Yellow Output LED:</b> OFF  <b>Green Power LED:</b> Flashes 2x - no delay          Flashes 4x - delay active (20 ms)</p> 
<b>Change Delay Setting</b>	<ul style="list-style-type: none"> <li>To change delay, quickly press ("click") push button and watch for Power LED to flash green.</li> <li>Repeat step to activate or deactivate delay, as desired.</li> </ul> 	<ul style="list-style-type: none"> <li>To change delay, pulse remote line again, and watch for Power LED to flash green.</li> <li>Repeat step to activate or deactivate delay, as desired.</li> </ul> 	<p><b>Yellow Output LED:</b> OFF  <b>Green Power LED:</b> Flashes 2x - no delay          Flashes 4x - delay active (20 ms)</p> 
<b>Exit SETUP Mode</b>	<ul style="list-style-type: none"> <li>Wait 10 seconds.*</li> </ul>	<ul style="list-style-type: none"> <li>Wait 10 seconds.*</li> </ul>	<p><b>Yellow Output LED:</b> OFF  <b>Green Power LED:</b> ON</p> <p>Sensor returns to RUN mode with new setting.</p> 

\*Sensor has a 10-second time-out. If a 10-second interval elapses without the button being pushed (or the remote line being pulsed), the sensor returns to RUN mode with the current delay setting stored.

# QL50 Luminescence Sensor

---

## Installing the Luminescence Sensor

1. Position the swivel M12 connector as needed. Push and hold slide-release while rotating connector.
2. Measure the appropriate operating distance from the front surface of the sensor optics to the surface or object to be sensed. Do not exceed 40 mm (1.57").
3. Fasten the sensor to its intended location using two screws and washers. Any two of three holes in the housing may be used for this purpose.
4. Attach the power cable to the sensor's connector; see hookups on back cover.

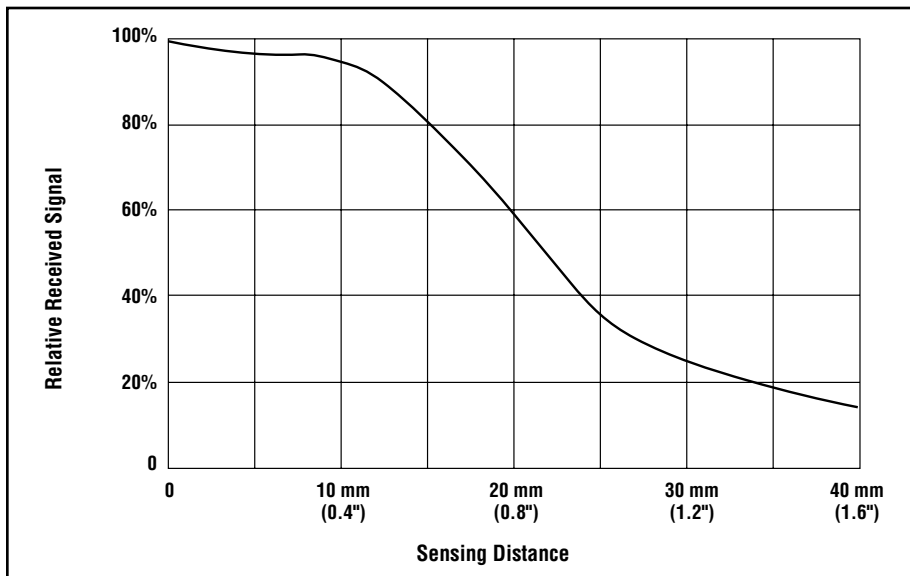



Figure 5. Relative received signal vs. distance

# QL50 Luminescence Sensor

## Specifications

<b>Sensing Beam</b>	Ultraviolet LED (370 nm)
<b>Supply Voltage</b>	10 to 30V dc, 2Vpp max ripple 30 mA max exclusive of load
<b>Supply Protection Circuitry</b>	Protected against reverse polarity and transient voltages
<b>Output Configuration</b>	PNP or NPN discrete output, depending on model 30V dc max <b>Leakage Current:</b> <1 µA
<b>Output Rating</b>	100 mA maximum load
<b>Output Protection</b>	Protected against output overload and short circuit
<b>Output Response Time</b>	250 microseconds
<b>Adjustments</b>	1 push button (set), and remote program wire: <ul style="list-style-type: none"> <li>• Fine-detect autoselect for Light Operate or Dark Operate</li> <li>• 20 ms output OFF-delay</li> <li>• Remote wire to +V dc for remote programming and/or push-button lockout</li> </ul>
<b>Indicators</b>	<b>Yellow Output LED:</b> ON when output is conducting <b>Bicolor Ready/Error LED:</b> Green ON = Default and Quick-Set programming RUN mode Green OFF = Threshold Green Flashing = Fine-Detection Program mode/Delay status Green/Red bicolor flashing = programming error
<b>Construction</b>	ABS shock-resistant housing; glass lens and window (tilted, antireflective)
<b>Environmental Rating</b>	IEC IP62
<b>Connections</b>	4-pin Euro-style (M12) swivel QD connector. Cable required; see page 8 for available cable options.
<b>Operating Conditions</b>	<b>Temperature:</b> -25° to +55°C (-13° to +131°F) <b>Max. Relative Humidity:</b> 90% at 50°C non-condensing
<b>Data Retention</b>	EEPROM nonvolatile memory
<b>Sensing Range</b>	0 to 40 mm (0 to 1.57") Maximum signal at 10 mm (0.39")
<b>Spot Diameter</b>	1.5 mm @ 10 mm (0.059" @ 0.39")
<b>Ambient Light Rejection</b>	According to EN 60947-5-2
<b>Shock Resistance</b>	30 G; 3 shocks per axis; 11 ms duration
<b>Vibration</b>	0.5 mm (0.02") amplitude; 10 to 60 Hz frequency; 30 minutes for each X, Y, Z axis
<b>Certifications</b>	 

# QL50 Luminescence Sensor

## Dimensions

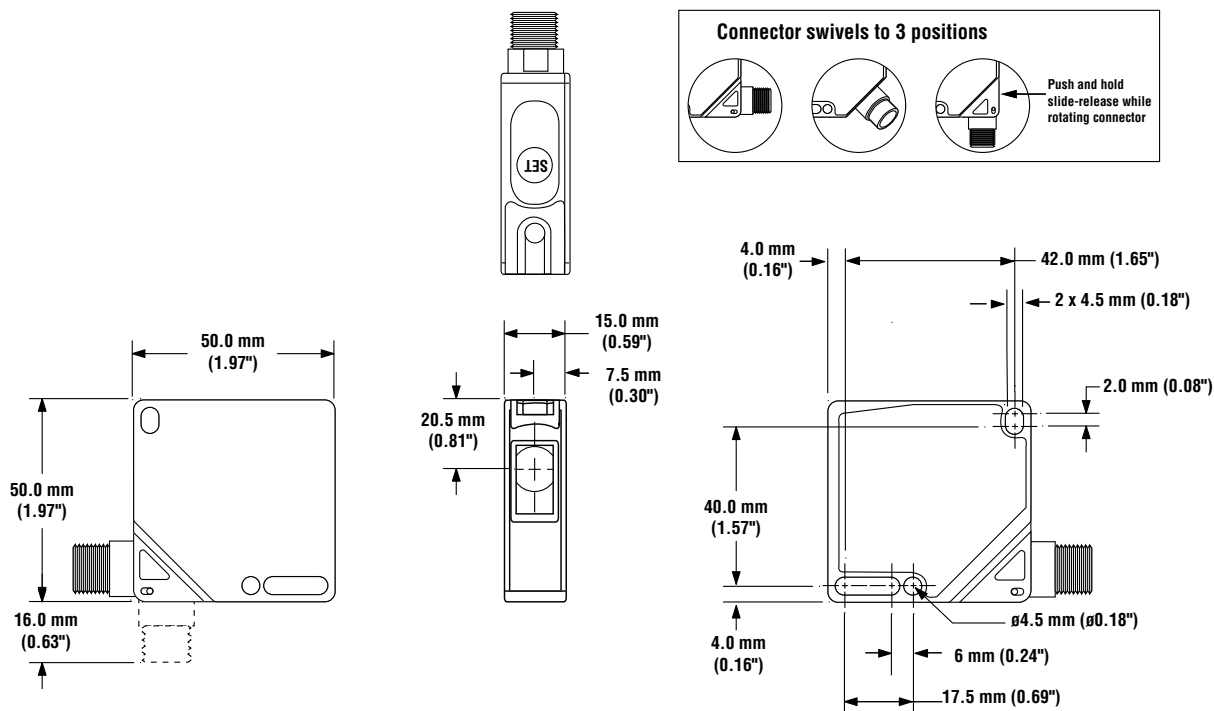

## Hookups

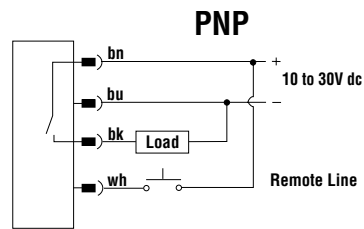
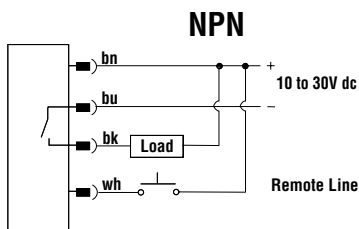

## QD Cables

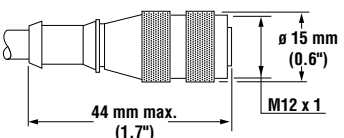
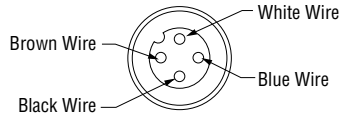
Style	Model	Length	Dimensions	Pinout
4-Pin Straight Euro-style (M12)	<b>MQDC-406</b> <b>MQDC-415</b> <b>MQDC-430</b>	2 m (6.5') 5 m (15') 9 m (30')		



**WARRANTY:** Banner Engineering Corp. warrants its products to be free from defects for one year. Banner Engineering Corp. will repair or replace, free of charge, any product of its manufacture found to be defective at the time it is returned to the factory during the warranty period. This warranty does not cover damage or liability for the improper application of Banner products. This warranty is in lieu of any other warranty either expressed or implied.