



# TM18 Series Sensors



Self-contained dc-operated photoelectric sensors in a robust metal housing



## Features

- Robust die-cast nickel-plated housing with sealed membrane switch is designed to meet IEC IP67 requirements
- Excellent immunity to noise, including high-speed-switching fluorescent lamps and EMI (electromagnetic interference)
- Simple single-button setup procedure
- Selectable light operate/dark operate (push-button toggle)
- Models with selectable NPN or PNP operation (see hookups) or dedicated single NPN or PNP output; 300mA current rating
- Enhanced optical crosstalk avoidance

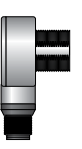
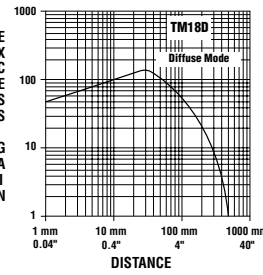
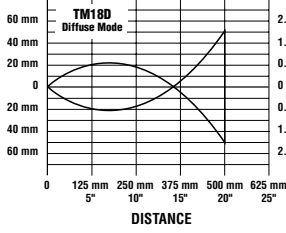
## Models

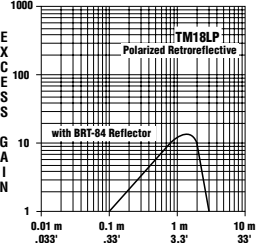
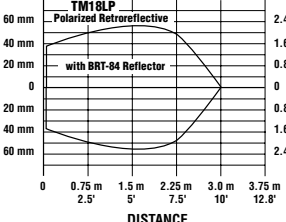
Sensing Range	Model	Range	Cable*	Output	Excess Gain	Beam Pattern		
					Data taken at 25° C			
Diffuse 	880 nm Infrared	500 mm (19")	2 m (6.5') 4-wire PVC cable	Selectable NPN or PNP				
	TM18BM6D						4-pin Euro-style 150 mm (6") polyurethane (PUR) pigtail QD	NPN
	TM18N6DQP							PNP
Polarized Retroreflective 	660 nm Visible Red	3 m (10') See Note (1)	2 m (6.5') 4-wire PVC cable	Selectable NPN or PNP				
	TM18BM6LP						4-pin Euro-style 150 mm (6") polyurethane (PUR) pigtail QD	NPN
	TM18N6LPQP							PNP
TM18P6LPQP								

\*For selectable NPN/PNP models, other cable/connector options are available:

- **9 m cable:** add suffix "W/30" to the model number (e.g., **TM18BM6D W/30**)
- **4-pin Euro-style integral QD:** add suffix "Q" to the model number (e.g., **TM18BM6DQ**)

(1) Retroreflective range is specified using one model BRT-84 reflector. Actual sensing range may be more or less than specified, depending upon efficiency and reflective area of the reflector(s) in use. For example, using a BRT-92x92C reflector will increase range to 5 m.



### WARNING . . . Not To Be Used for Personnel Protection

Never use these products as sensing devices for personnel protection. Doing so could lead to serious injury or death.

These sensors do NOT include the self-checking redundant circuitry necessary to allow their use in personnel safety applications. A sensor failure or malfunction can cause either an energized or de-energized sensor output condition. Consult your current Banner Safety Products catalog for safety products which meet OSHA, ANSI and IEC standards for personnel protection.

# TM18 Series Sensors – Self-Contained Photoelectric Sensors in a Metal Housing

## Sensor Configuration

Configuring the TM18 sensor is easy, using one push-button switch on the sensor housing. Set the sensor for application sensing conditions using Dark SET, or toggle between Light Operate or Dark Operate sensing with the same button.

Dark SET allows the sensor to maximize the signal-to-noise ratio without setting multiple targets. With Dark SET, the sensor learns the darkest condition. For diffuse models, this is typically the area behind the object to be sensed. For LP models, this is typically the object to be sensed.

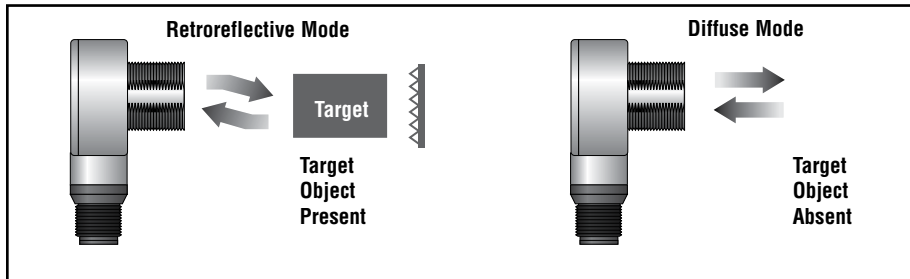

Figure 1. Dark sensing condition

### Dark SET Procedure

- **Diffusemode:** Remove object to be sensed from sensor's field of view.
- **Retroreflective mode:** Place object to be sensed between the retroreflector and the sensor.
- Press push button approximately 2 seconds; Signal LED flashes yellow/green.
- Release button; LED stops flashing when programming is complete.

### Light Operate/Dark Operate Select

Select Light Operate (output conducts when object is present) or Dark Operate (output conducts when object is absent) using the push button to toggle between the selections. Toggling the sensing mode does not affect the sensor's gain.

- Press push button approximately 10 seconds; release push button.
- Signal LED flashes yellow/green, followed by 5 flashes of 1 color to designate current selection:  
5 green flashes = Light Operate  
5 yellow flashes = Dark Operate

Sensor Condition	Power LED	Signal LED
<b>RUN Mode</b>		
Signal Absent	ON	OFF
Signal Present	ON	Yellow
<b>SET Mode</b>	ON	Flashes yellow/green during configuration
Toggled to Light Operate	ON	Final 5 flashes – green
Toggled to Dark Operate	ON	Final 5 flashes – yellow

Figure 2. Indicator status during RUN and TEACH modes

# TM18 Series Sensors – Self-Contained Photoelectric Sensors in a Metal Housing

## Specifications

<b>Supply Voltage</b>	10 to 30V dc (10% maximum ripple) at less than 40 mA, exclusive of load Protected against reverse polarity and transient voltages
<b>Output Configuration</b>	<b>Solid-state selectable models:</b> NPN or PNP (current sinking or sourcing); depending on hookup <b>Dedicated single-output models:</b> NPN or PNP (current sinking or sourcing); depending on model <b>Rating:</b> 300 mA maximum output at 25°C <b>Off-state leakage current:</b> NPN less than 100 µA @ 30V dc PNP less than 300 µA @ 30V dc <b>ON-state saturation voltage:</b> less than 1V @ 10 mA; less than 1.5V @ 300 mA Protected against false pulse on power-up and continuous overload or short circuit of outputs
<b>Output Response</b>	3 milliseconds ON/OFF NOTE: 300 millisecond delay on power-up; outputs do not conduct during this time
<b>Repeatability</b>	300 microseconds maximum
<b>Adjustments</b>	Push-button dark SET, light/dark operate toggle NPN/PNP selected via hookup
<b>Indicators</b>	2 LED indicators: Power ON/OFF (green) Signal (bi-color yellow/green)
<b>Construction</b>	Copper/nickel-plated zinc alloy housing; rated IEC IP67; NEMA 6
<b>Connections</b>	2 m (6.5') 4-wire PVC cable, 9 m (30') PVC cable, 4-pin Euro-style integral QD, or 4-pin Euro-style 150 mm (6") polyurethane pigtail QD, depending on model (see model listing on page 1)
<b>Operating Conditions</b>	<b>Temperature:</b> -20° to +55° C (-4° to +132° F) <b>Relative Humidity:</b> 90% @ 50° C (non-condensing)
<b>Certifications</b>	

## Dimensions and Features

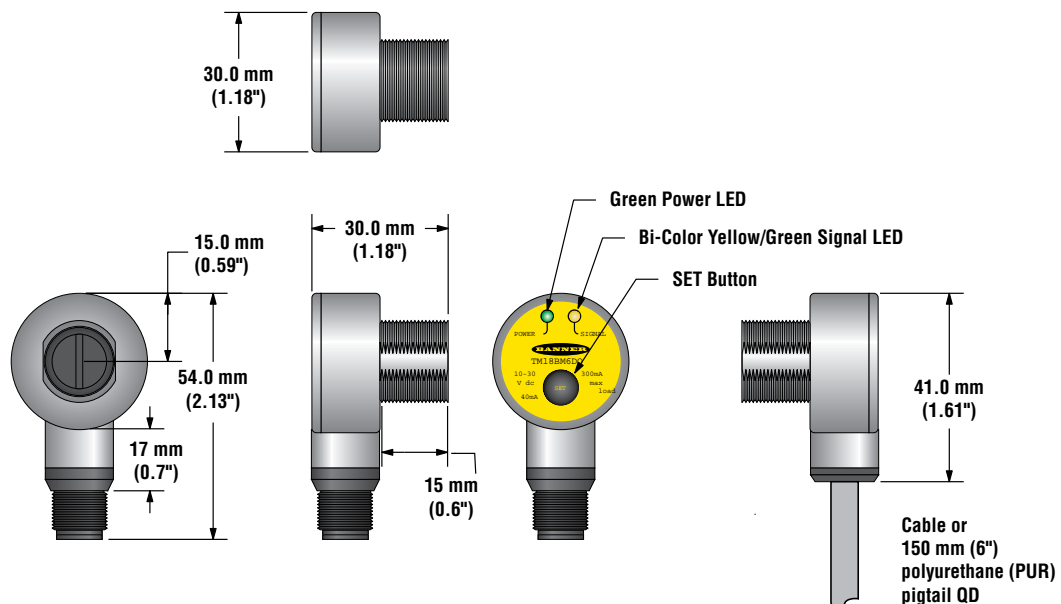

# TM18 Series Sensors – Self-Contained Photoelectric Sensors in a Metal Housing

## Hookups

### Selectable-Output Models

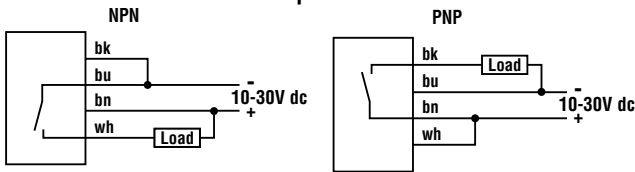

### Dedicated-Output Models

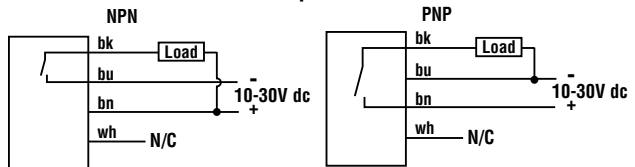

NOTE: QD model hookups are functionally identical.

## Accessories

### Quick-Disconnect Cables

Style	Model	Length	Dimensions
4-pin straight	<b>MQDC-406</b>	2 m (6.5')	
	<b>MQDC-415</b>	5 m (15')	
	<b>MQDC-430</b>	9 m (30')	
4-pin right-angle	<b>MQDC-406RA</b>	2 m (6.5')	
	<b>MQDC-415RA</b>	5 m (15')	
	<b>MQDC-430RA</b>	9 m (30')	

### SMBT18Y

- Die-cast bracket
- Accommodates Euro-style QD connectors and cabled sensor models

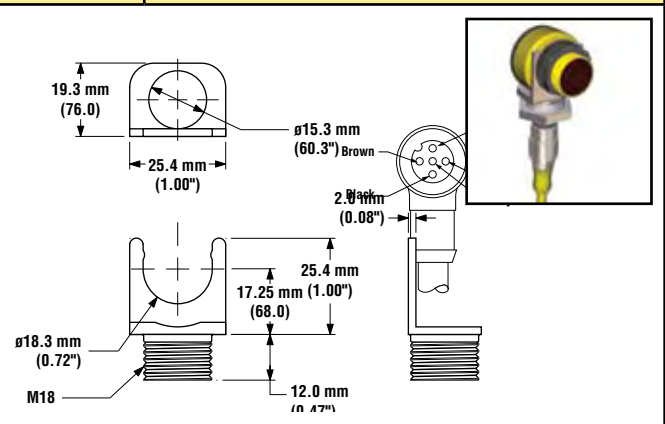

more sensors, more solutions

**WARRANTY:** Banner Engineering Corp. warrants its products to be free from defects for one year. Banner Engineering Corp. will repair or replace, free of charge, any product of its manufacture found to be defective at the time it is returned to the factory during the warranty period. This warranty does not cover damage or liability for the improper application of Banner products. This warranty is in lieu of any other warranty either expressed or implied.