

ULTRA-BEAM™ 923 Series

Ultrasonic Proximity Sensors with Analog Outputs



- **Reliable proximity and distance sensing of materials regardless of transparency or color**
- **Senses objects as close as 20 inches or as far as 20 feet from sensor face; adjustable sensing window**
- **Sourcing and sinking analog outputs, positive or negative slope; easily interfaced to variable speed DC motor drives, microprocessors, and programmable controllers**
- **Ideal for fill level sensing, position sensing (guidance), web tensioning, size sorting, and centering control applications**
- **Models available for 18-30V dc, 105-130V ac, or 210-260V ac power source**



Banner "923" series ULTRA-BEAMs are rugged, reliable *ultrasonic* proximity sensors with analog outputs. They are ideal for applications that require proximity mode distance sensing and a continuous linear analog output (voltage sourcing or current sinking) throughout an adjustable sensing range. Typical applications are fill level sensing, position sensing and guidance, web tensioning and positioning, size sorting of objects on production lines, and centering control. Banner ULTRA-BEAM analog outputs interface directly to ordinary voltmeters and milliammeters, LED bargraphs, variable speed DC motor drives, microprocessors, and programmable controllers.

Use of ultrasonics (*sound* waves, not light) enables Banner ULTRA-BEAMs to detect objects that are totally undetectable or only marginally detectable by photoelectric (light dependent) methods. ULTRA-BEAM ultrasonic sensors can reliably detect objects *regardless of their color or transparency to light*. Banner analog ULTRA-BEAMs can sense the presence of clear glass or film just as reliably as they can detect the presence of a solid metal object of the same profile. When one of ULTRA-BEAM's analog outputs is connected to an appropriate instrument (even an accurately calibrated DC voltmeter or milliammeter will suffice) the distance from the sensor face to a surface perpendicular to the sensing axis can be read with accuracy.

"923" series analog ULTRA-BEAMs have a sensing range of 20" to 20', with the response pattern shown in figure A. Easily-accessible 15-turn clutched potentiometers (NULL and SPAN adjustments, located on top of the unit) allow the limits to be shifted to create a "sensing window" of adjustable "depth" anywhere within the 20" to 20' range (see figure B). The limits of the sensing window can easily be reset when sensing requirements change.

The maximum depth of the adjustable sensing window is 18'4"; the minimum depth is 12". Objects beyond the far end of the window are ignored. Objects within the beam pattern and between the sensor and the near end of the window, however, will block the ultrasonic beam and prevent operation. For proper operation, an average target object should present to the sensor a minimum of 1 square foot of reflective surface area for every 10 feet of sensing distance.

ULTRA-BEAM's analog outputs may be set to either increase or decrease with increasing distance to objects that are sensed within the sensing window. Output that increases with distance from the sensor is described as having *positive* slope. Output that decreases with distance has *negative* slope (figures E and F, page 4).

"923" series ULTRA-BEAMs have a special relative distance indicating system, which pulses a top-mounted red LED when an object is

SPECIFICATIONS

SENSING MODE: ultrasonic proximity

SENSING RANGE: 20 inches to 20 feet at 20°C.

Minimum required target area is 1 square foot (0,1 square meter) for each 10 feet (3 meters) of sensing range.

SENSING WINDOW ADJUSTMENTS: sensing window depth is adjustable from 12" to 18'4" via two top-mounted 15-turn clutched potentiometers with slotted brass elements (NULL and SPAN adjustments). This adjustable window may be placed anywhere within the 20" to 20' sensing range.

OUTPUTS:

Two analog solid-state outputs:

0 to +10V dc (sourcing); minimum 500Ω load

0 to 20mA dc (sinking); 4.0V dc maximum voltage drop

Both outputs may be set for either "positive slope" or "negative slope"

RESPONSE TIME: 100 milliseconds

INDICATOR LED: top-mounted red LED indicator lights whenever power is applied to the sensor, and pulses at a 0 to 10Hz rate which is proportional to analog output voltage (sourcing output) and current (sinking output)

OPERATING TEMPERATURE RANGE: 0 to 50°C (+32 to 122°F). Maximum humidity 90% (non-condensing conditions).

SUPPLY VOLTAGE:

Model **SU923QD:** 18 to 30V dc, 5VA

Model **SUA923QD:** 105 to 130V ac (50/60Hz), 5VA

Model **SUB923QD:** 210 to 260V ac (50/60Hz), 5VA

CIRCUIT PROTECTION: inputs are protected against polarity reversal (DC models); both analog outputs are protected against short circuit of outputs (AC and DC models).

CABLE: 4-pin (for SU923QD) or 5-pin (for SUA923QD and SUB923QD) Quick Disconnect ("QD") type connectors are standard. NOTE: use 4-conductor (model MBCC-412) or 5-conductor (model MBCC-512) SO-type cable, 12 feet long (order separately, see page 6).

CONSTRUCTION: overall dimensions 4.7"H x 2.0"W x 1.9"D; rugged molded Valox™ housing; epoxy-encapsulated circuitry. NEMA 1, 3, and 12. Mounting nut and lockwasher supplied. sensed. The 0 to 10Hz pulse rate is proportional to the sensor's analog output and to the object's position within the sensing window.



WARNING These ultrasonic sensing devices do NOT include the self-checking redundant circuitry necessary to allow their use in personnel safety applications. A sensor failure or malfunction can result in *either* an energized or a de-energized sensor output condition.

Never use these products as sensing devices for personnel protection. Their use as safety devices may create an unsafe condition which could lead to serious injury or death.

Only MACHINE-GUARD and PERIMETER-GUARD Systems, and other systems so designated, are designed to meet OSHA and ANSI machine safety standards for point-of-operation guarding devices. No other Banner sensors or controls are designed to meet these standards, and they must NOT be used as sensing devices for personnel protection.

(continued next page)

FIGURE A: Response Pattern, "923" Series Sensors

- 1) The "sensing axis" is an imaginary line originating at and perpendicular to the center of the transducer.
- 2) Response pattern is drawn for a 2 square foot smooth, solid surface.
- 3) Symmetry of the pattern may be assumed in all sensing planes.
- 4) The rounded portion of the curve past the 20' point indicates an area where sensing is unreliable. Effective range is from 20' to 20' (0.5 to 6m).

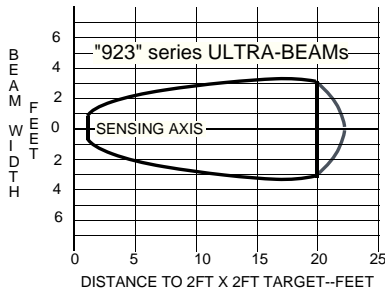

DIMENSIONS

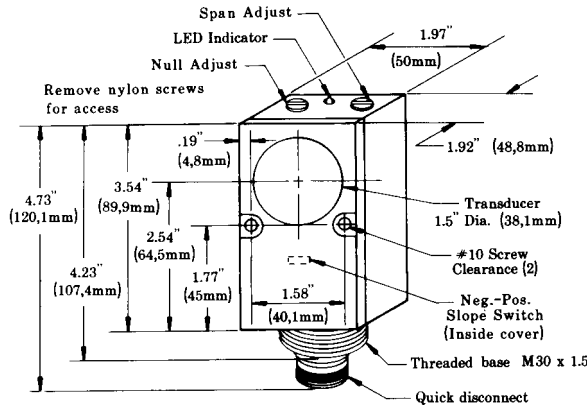
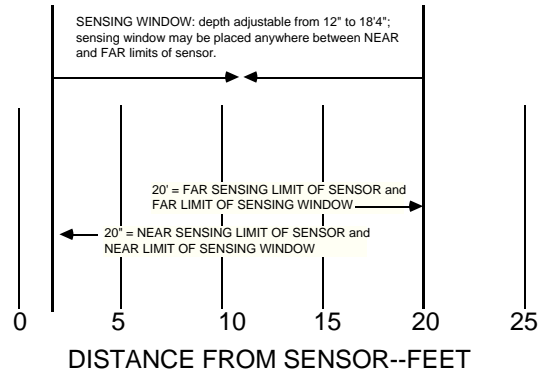

FIGURE B: "Sensing Window" Concept



"QD" (Quick Disconnect) connectors are standard on ULTRA-BEAM sensors. DC models use a 4-pin connector; AC models use a 5-pin connector. Mating 12-foot SO-type cables must be ordered separately.

Three sensor models are available, based on operating (power supply) voltage: model SU923QD for 18-30V dc, model SUA923QD for 105-130V ac, and model SUB923QD for 210-260V ac (see specifications).

ULTRA-BEAM "923" series sensor housings are constructed of tough, corrosion-proof molded Valox™. Electronic circuitry is epoxy encapsulated for shock and vibration resistance. The ultrasonic transducer (protected by a stamped metal screen) will not be damaged by temporary contact with moisture, but should be kept free of condensation and contamination for optimum operation.

The Banner model SMB900 two-axis mounting bracket is ideal for use with "923" series sensors.

BASIC THEORY OF ULTRASOUND

How Ultrasonics are Generated

Ultrasonics are sound waves of frequencies above the range of human hearing. Like all sound waves, ultrasonic waves (or "ultrasound") are produced by a vibrating object. In ULTRA-BEAM sensors, the vibrating object is called a *transducer*. It is constructed of thin, highly flexible gold-plated plastic foil stretched over an aluminum backplate which is held in place by a leaf spring. The transducer is part of an electrical circuit, and vibrates when an AC voltage (of the desired operating frequency of the transducer) is applied to it. This vibration causes an audible "ticking" sound from the transducer. The sound is normal: each "tick" is a string of 16 ultrasonic sensing pulses.

The AC voltage, which can be visualized as a sine wave, alternately compresses and expands the transducer. This action compresses and expands the air molecules in front of the sensor, sending "waves" of ultrasonic sound outward from the transducer's face. In ULTRA-BEAM sensors, the transducer is not *constantly* transmitting ultrasonic sound, but instead is switched "on" and "off" at a regular rate. During the "off" times (in between "ticks"), the transducer acts as a receiver and *listens* for ultrasonic waves reflected from objects in its path.

Behavior of Ultrasonic Waves

A basic knowledge of how ultrasonic waves behave in air can be of help in using ultrasonic sensors successfully:

(1) The intensity of ultrasonic sound decreases with the square of the distance from the sound source. For example, if the intensity of ultrasonic sound at a distance of 1' in front of the sensor is designated as "1", then the intensity at 3 times that distance is $(1/3)^2$, or $1/9$ th.

If the radiated sound hits an object and is reflected back to the transducer, the object becomes the "source" for the waves on the return trip, and the intensity of the waves is reduced *again* by the square of the distance. *The stronger the generated ultrasonic waves, the stronger will be the returned waves. And, the more efficient the object is as a reflector of ultrasonic waves, the stronger will be the returned waves.*

FUNCTIONAL SCHEMATIC

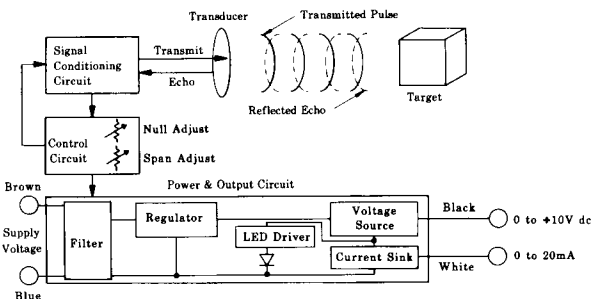

(2) Ultrasonic waves are affected by the size, density, orientation, shape, surface, and location of the object being sensed.

a) Size of the object: at a given distance in front of the sensor, a large object reflects more ultrasonic energy than does a smaller, otherwise identical object at the same position, and so is more easily sensed. The recommended object size for "923" series sensors is 1 square foot of reflective surface area *presented to the sensor* for each 10' of sensing distance. This is an "average figure", and is influenced by other characteristics of the object being sensed.

b) Density of the object: *density is the mass of an object per unit of volume. The more dense the object being sensed, the stronger is the sound reflection, and the more reliably the object can be sensed.* This fact calls to mind experiences with audible sound in everyday life. For example, a wall covered with hardboard paneling reflects sound more efficiently than does a wall covered only by foam insulation panels. The hardboard paneling is denser than the foam. Ultrasonics are affected similarly. Note that water and other liquids (although they are certainly not solid) are nonetheless denser than materials like foam. This makes them better reflectors than foam. The table on the next page lists some materials and their relative effectiveness as ultrasonic reflectors.

TABLE: Relative Effectiveness of Various Materials as Reflectors of Ultrasound (rough order, best to worst)

Smooth, flat steel plate (best)	Foam insulation panel
Smooth, flat plywood sheet	Fine particulates (flour, grain, etc)
Undisturbed liquid surface	Liquid with heavy surface foam
Aggregate (coal, ore, etc.)	Wool, cotton, felt
Smooth, flat corrugated cardboard	Fiberglass insulation (worst)

General rules:

- 1) The higher the density of the object, the stronger the reflection.
- 2) The smoother the surface of the object, the stronger the reflection.

c) Object orientation, shape, and surface characteristics: Ultrasonic waves follow the same laws of reflection as do light waves. *The angle of incidence equals the angle of reflection.* This means that ultrasonic waves are reflected from a smooth, flat surface at the same angle (to the surface) as the angle at which they arrive. A perfectly flat object that is exactly perpendicular to the direction of travel (the "axis") of the ultrasonic waves will reflect the waves back along the same path (figure C). Objects thus oriented produce strong reflections when sensed.

FIGURE C. THE ANGLE OF INCIDENCE EQUALS THE ANGLE OF REFLECTION

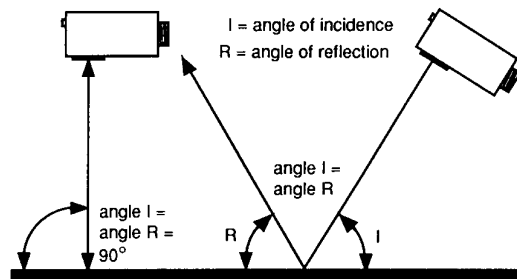

As the object's reflecting surface is tilted away from the axis of the waves, however, less and less of the ultrasonic signal is reflected back to the sensor. Eventually the point is reached beyond which the object can no longer be sensed. *When attempting to sense an object with a flat, smooth, highly reflective surface, the angle of the reflecting surface to the sensing axis should never be more than 3° off of perpendicular.*

Irregularly shaped objects and aggregate matter (coal, ore, sand, flour, etc.) have many reflecting faces of many different angles. Although this scatters much of the ultrasonic energy away from the sensor, enough sound energy may be reflected back to the sensor for reliable sensing. In fact, due to the large number of reflecting surfaces, the "perpendicularity requirement" for smooth objects is not nearly as critical for these materials. Sensor angles of up to several degrees away from perpendicular often produce adequate reflections (figure D). Some materials may actually produce just as good reflections when sensed "at an angle" as when sensed "straight on". This allows a degree of freedom in choosing a sensor mounting location for some applications. Some trial-and-error experimentation may be required.

FIGURE D. REFLECTIONS FROM IRREGULAR SURFACES

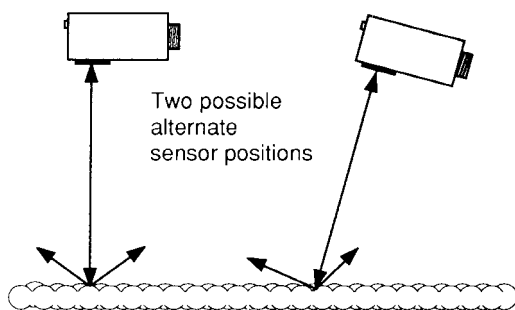

d) Location of the object within the sensor's response pattern: the ultrasonic signal radiated from the ULTRA-BEAM is strongest along the axis of the response pattern (the "sensing axis"), and drops off with increasing angle away from the axis. *Objects can be most reliably sensed when they are as close as possible to the sensing axis.*

e) Location of sidewalls with respect to the beam pattern. *Sidewalls* located close to the sensing axis may sometimes cause unwanted signals to be reflected back to the sensor. Unwanted reflections may also occur from deposits of material adhering to the sidewalls of silos, tanks, etc. If possible, align the sensor so that its beam pattern will not encounter sidewalls, and try to keep sidewalls free of buildup.

3) Extreme environmental conditions may affect ultrasonic sensing. Factors which may need to be considered include: temperature, high winds, high levels of sounds of certain types, humidity, atmospheric pressure, and dirt or moisture on the transducer.

a) The speed of sound increases and decreases slightly with increases and decreases in ambient temperature. A large temperature increase will move the window slightly *towards* the sensor. A large temperature decrease will move the window slightly *away* from the sensor.

The amount of shift is 3.5% for every 20°C of temperature change. **For this reason, it is a good idea to set the sensing window limits when the ambient temperature is midway in the expected environmental operating temperature range of the sensor. Also, whenever it is consistent with the application, adjust the sensing window so that the object(s) to be sensed will pass as much as possible through the midpoint of the window.**

Fluctuations in the speed of sound can result when hot objects are sensed. A small fan directed *along the sensing axis* can help to thermally stabilize the sensing path and make accurate readings possible.

b) In outdoor applications, crosswinds can blow an ultrasonic beam off target. The effect becomes more noticeable as the wind velocity and the distance to the object being sensed increase. Try to avoid sensing in areas of high crosswinds. When it is necessary to use ultrasonics in windy areas, keep the sensing range as short as possible, and shield the area from the wind as effectively as possible. Winds blowing *steadily along the sensing axis*, toward or away from the sensor, have less effect. *Gusty winds* along the sensing axis may affect output stability.

c) Care should be taken to shield ultrasonic sensors from sustained, loud sounds such as factory whistles and similar sources. Sound sources produce *harmonics* (sounds at frequencies above the fundamental frequency of the source). Harmonics may fall in the ultrasonic range and "confuse" ultrasonic sensors. **High pressure air blasts** are especially good producers of harmonics in the ultrasonic range. Since sound waves travel in a straight line from the harmonic source to the sensor, **the solution is simple:** a wall or baffle placed between the sensor and the harmonic source is nearly always all that is required. This tactic can also help prevent interference between adjacent ultrasonic sensors.

d) Humidity influences ultrasonic sensing by a maximum of 2% with *extreme* changes of humidity. The *speed* of sound increases with increasing humidity. Heavy atmospheric fog can increase sound absorption and reduce sensing *range*.

e) Atmospheric pressure: a 5% increase in atmospheric pressure increases the speed of sound by 0.6%. A 5% decrease in pressure slows the speed of sound by 0.6%.

f) Condensation or other contamination on the transducer face can seriously impede sensor performance, and should be avoided. In order to function, the transducer must be able to vibrate freely and at a high rate. Condensation or particulates on the transducer dampens its movement. While the transducer is not *harmed* by mists or non-condensing humidity, it should be *clean and dry* to operate most effectively.

Most contamination can be prevented by mounting the sensor in the driest, cleanest location possible that still allows reliable sensing performance in a given application. **Never mount the sensor "face up" in areas where contamination might be a problem.**

ULTRASONIC SENSING WITH BANNER "923" SERIES ULTRA-BEAMS

In simplest terms, ULTRA-BEAM ultrasonic sensors operate by transmitting ultrasonic sound pulses of a specific frequency (inaudible to the ear) and, in between the transmitted pulses, listening for reflected pulses ("echoes") of the same frequency from an object in the path of the ultrasonic beam. The sensor "knows" the speed of ultrasound and measures the time lapse between the transmitted ultrasonic pulses and the reflected echoes. The result is an analog output which represents the distance from the sensor to the reflecting object. If the distance between the sensor and the object changes, the ULTRA-BEAM sees a change in the time lapse and, within 100 milliseconds, updates and puts out new analog values. "923" series analog ultrasonic sensors can not only detect the presence of an object, but also give a *continuous* indication of the object's position along the sensing axis. (Note: the receiver *must* receive an "echo" in order to update its output. This echo usually is produced by the objects being sensed. If the object is removed from the sensing window, the next "update" echo may come from any object within the sensor's beam pattern, either inside or outside the sensing window.)

By means of the internal SLOPE SELECT jumper switch, ULTRA-BEAM's analog outputs may be set to produce either a *positive* or *negative slope*. When adjusted for *positive* slope, the ULTRA-BEAM's analog outputs (both voltage sourcing and current sinking) *increase* as the object being sensed moves away from the sensor along the sensing axis (figure E).

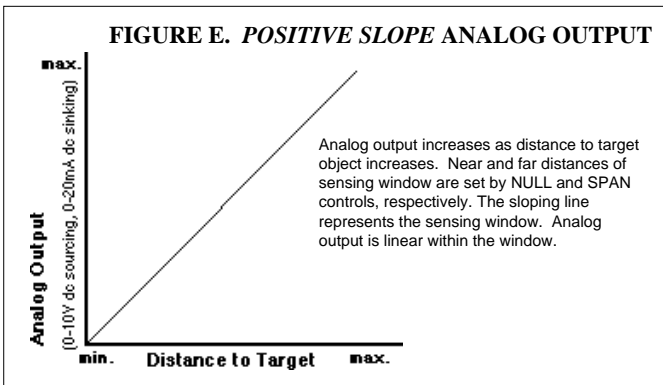

When adjusted for negative slope, both analog outputs *decrease* as the object moves away from the sensor along the sensing axis (figure F).

Figures E and F are typical responses for applications like fill level sensing, position sensing, and web tensioning, where movement along the sensing axis toward and away from the sensor must be monitored and/or controlled.

Reliable distance sensing is possible for objects crossing the beam pattern at right angles to the sensing axis. In both the positive and the negative slope modes, an object moving along a path *perpendicular* to the sensing axis will begin to produce an analog output as it enters the sensor's pattern. Output will continue until the object moves out of the ULTRA-BEAM's sensing pattern.

ULTRA-BEAM sensors may also be used to detect size differences in objects that are moving past the sensor at right angles to the sensing axis, as on a conveyor. It is best to think of the objects as being differentiated by their *distance* from the sensor rather than by their actual *size*. The surfaces of the objects being sensed must be presented to the sensor in such a way that size differences in the objects are seen as dimensional differences along the sensing axis. These distances can be detected by the sensor as changing sensor-to-object distances from one object to another, and can be differentiated by changes in the analog output.

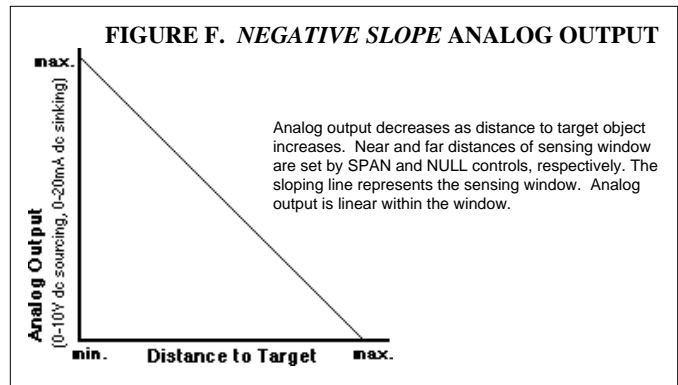

ADJUSTMENT OF "923" SERIES SENSORS

Installation and adjustment of "923" series ULTRA-BEAMs is performed as described below. Some means of monitoring the ULTRA-BEAM's analog output(s) is necessary. This can be done either by the "final device" in the application or by a voltmeter or milliammeter connected as shown in figures J, K, L, & M.

1) Choose either voltage sourcing or current sinking output, and either positive slope or negative slope. The choice of sourcing or sinking output will depend upon the input requirements of the instrument that the ULTRA-BEAM will be connected to.

The choice of positive or negative slope will depend upon the requirements of the "final device" used and the "direction" of the "action" that the analog output is to control or monitor. Positive slope analog output (figure E) *increases* with increasing distance to the target object; negative slope analog output (figure F) *decreases* with increasing distance to the target object. The maximum and minimum output levels, when set, will define the sensing window: the sourcing output range is 0 to +10V dc; the sinking output range is 0 to 20mA dc. The sensor's analog output is linear within these ranges.

Refer to the Dimension Drawing (p. 2) and figure G. Disconnect power from the sensor. Remove the front panel of the sensor by removing the four mounting screws at the four corners of the rear panel. Set the sensor for POSITIVE or NEGATIVE slope by positioning the jumper clip on the POS/NEG SLOPE SWITCH behind the front panel in the appropriate position. Replace the panel.

2) Determine where the ULTRA-BEAM will be mounted and the proper position and "depth" of the sensing window. Best results will be obtained when the ULTRA-BEAM is adjusted

Figure G: ULTRA-BEAM Slope Select Jumper Setting

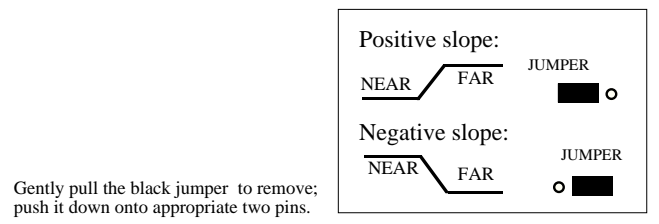

when mounted in the actual sensing position, and when "looking" at the actual material to be sensed. Mount the ULTRA-BEAM firmly and securely in a location as free as possible from spray, dust, and dirt, but which still allows reliable sensing. (Consider use of the Banner model SMB900 mounting bracket.)

Note: if adjusting the ULTRA-BEAM in the actual "sensing position" is not possible, "window" adjustments may be performed elsewhere. For best results, use a sample of the actual material to be sensed as the target (observe minimum target size requirement), and then move the sensor to its final position. More than one adjustment attempt may be necessary using this method. As a third alternative, use a smooth, flat target.

The window must include within its boundaries the closest and farthest positions (or levels) of the object(s) to be sensed. Allow for environmental effects, if anticipated. Whenever possible, set up the sensing window so that the object(s) will pass as nearly as possible through its center. Also, make sure that the window is adjusted to ignore objects beyond the target object(s).

3) Based on your choice in step 1, follow the appropriate adjustment procedure below:

a) Adjustment procedure for *positive slope* analog output

1) Make sure that the *slope select jumper clip* behind the front panel of the sensor is set for *positive slope* (see figure G). Remove the nylon screws covering the NULL and SPAN controls.

2) Connect the 0 to 20mA dc sinking output of the ULTRA-BEAM to a milliammeter (or the 0 to +10V dc sourcing output to a voltmeter) or to another instrument to be used for readout, as shown in Figures J, K, L, and M. Connect the sensor's power supply wires to an appropriate power supply. Double-check the connections and switch on the power. If the sensor is receiving power, a ticking noise will be heard from the sensor.

3) *Positive slope* means that the analog value of the sinking or sourcing output increases as sensor-to-object distance increases, and decreases as that distance decreases. The minimum and maximum current or voltage limits can be placed to define a sensing window 12" to 18'4" deep anywhere within the 20" to 20' overall sensor range. In the example at the right, a 5' deep window has been placed with its near edge at 10' and its far edge at 15'. **The NULL control sets the position of the near (minimum current or voltage) end of the slope; the SPAN control sets the position of the far (maximum current or voltage) end of the slope.**

4) Set your own sensing window as follows:

a) With a target object at the near end of the window, adjust the NULL control to just obtain a reading of 0.0mA (or your instrument's minimum current requirement) or 0.0V dc (or your instrument's minimum voltage requirement) on the readout instrument. The red LED on top of the sensor should pulse in proportion to the analog output. (If the NULL control is set for 0.0mA or 0.0V dc, there will be no pulsing.) Remove the target.

b) Place the target at the far end of the window. Adjust the SPAN control for a reading of 20mA (or your instrument's maximum current requirement) or +10V dc (or your instrument's maximum voltage requirement) on the readout instru-

FIGURE H: Example; 5' deep window, positive slope

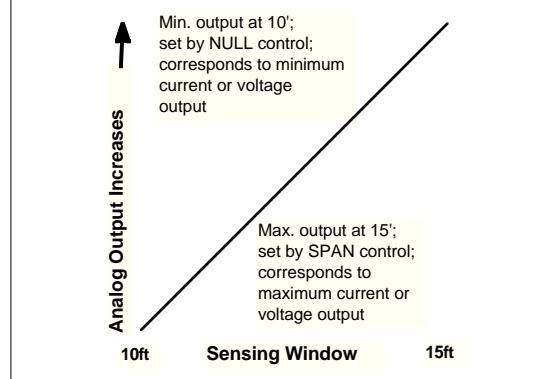

ment. The LED indicator should pulse at a rate proportional to the analog output. Remove the target.

c) Confirm your settings by reintroducing the target at the near edge of the sensing window. Move the target outward in steps along the sensing axis. The analog output should increase proportionately beginning with its set minimum, and reach its set maximum at the far edge of the sensing window, at which point the LED indicator should again pulse at its highest rate.

APPLICATION NOTE: with the sensor set for positive slope, the sensing window may be easily shifted along the sensing axis by moving the NULL setting. The depth of the window will remain constant.

b) Adjustment procedure for *negative slope* analog output

1) Make sure that the *slope select jumper clip* behind the front panel of the sensor is set for *negative slope* (see figure G). Remove the nylon screws covering the NULL and SPAN controls.

2) Connect the 0 to 20mA dc sinking output of the ULTRA-BEAM to a milliammeter (or the 0 to +10V dc sourcing output to a voltmeter) or to another instrument to be used for readout, as shown in Figures J, K, L, and M. Connect the sensor's power supply wires to an appropriate power supply. Double-check the connections and switch on the power. If the sensor is receiving power, a ticking noise will be heard from the sensor.

3) *Negative slope* means that the analog value of the sinking or sourcing output decreases as sensor-to-object distance increases, and increases as that distance decreases. The minimum and maximum current or voltage limits can be placed to define a sensing window 12" to 18'4" deep anywhere within the overall 20" to 20' sensor range. In the example at the right, a 5' deep window has been placed with its near edge at 10' and its far edge at 15'. **The NULL control sets the position of the near (maximum current or voltage) end of the slope; the SPAN control sets the position of the far (minimum current or voltage) end of the slope.**

4) Set your own sensing window as follows:

a) With a target object at the near end of the window, adjust the NULL control to just obtain a reading of 20mA (or your instrument's maximum current requirement) or +10V dc (or your instrument's maximum voltage requirement) on the readout instrument. The red LED on top of the sensor should pulse in proportion to the analog output. Remove the target.

b) Place the target at the far end of the window. Adjust the SPAN control for a reading of 0.0mA (or your instrument's minimum current requirement) or 0.0V dc (or your instrument's minimum voltage requirement) on the readout instrument.

FIGURE I: Example; 5' deep window, negative slope

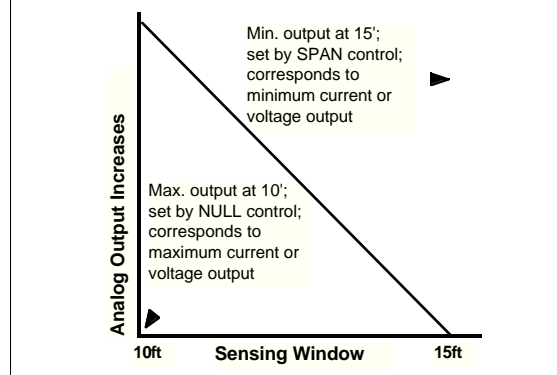

The LED indicator should pulse at a rate proportional to the analog output. (If the SPAN control is set for 0.0mA or 0.0V dc, there will be no pulsing.) Return the target to the near end of the window (same position as in step "a") and "fine-tune" the NULL setting by repeating step "a".

d) Confirm your settings by reintroducing the target at the far edge of the sensing window. Move the target inward in steps along the sensing axis. The analog output should increase proportionately beginning with its set minimum, and reach its set maximum at the near edge of the sensing window, at which point the LED indicator should again pulse at its highest rate.

WARRANTY: Banner Engineering Corporation warrants its products to be free from defects for a period of one year. Banner Engineering Corporation will repair or replace, free of charge, any product of its manufacture found to be defective at the time it is returned to the factory during the warranty period. This warranty does not cover damage or liability for the improper application of Banner products. This warranty is in lieu of any other warranty either expressed or implied.

Generalized Hookup Diagrams, sinking and sourcing output, AC and DC sensors

Banner "923" series analog ULTRA-BEAM sensors connect directly to voltmeters and milliammeters, LED bargraphs, variable speed DC motor drives, microprocessors, and programmable controllers. For specific hookup information, refer to the literature supplied with the instrument in use. If you have questions, contact Banner's Applications Engineering department during normal working hours.

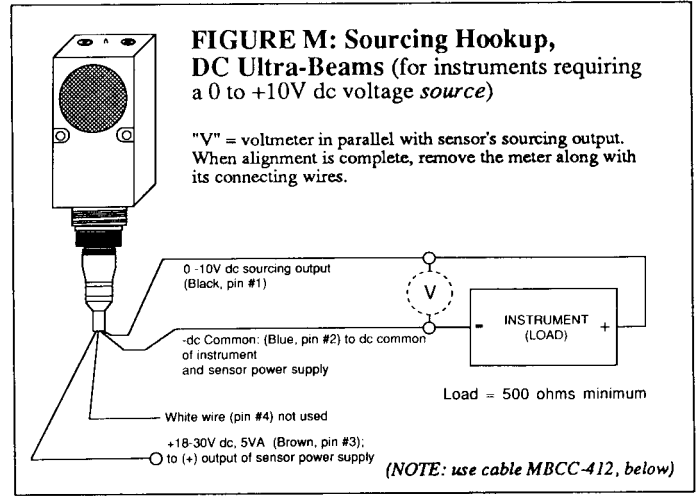
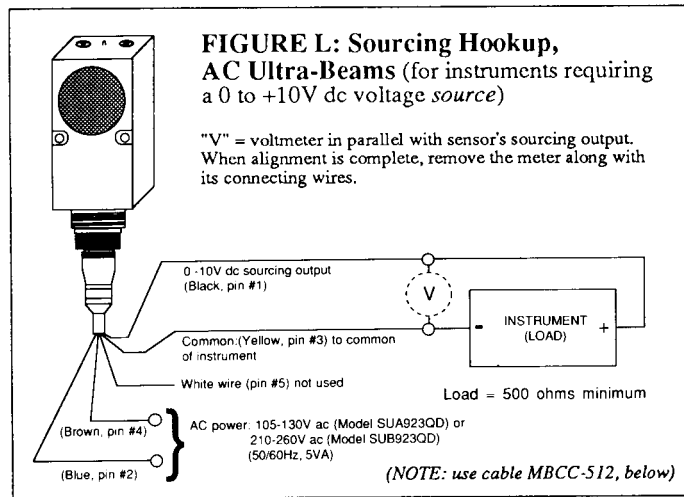
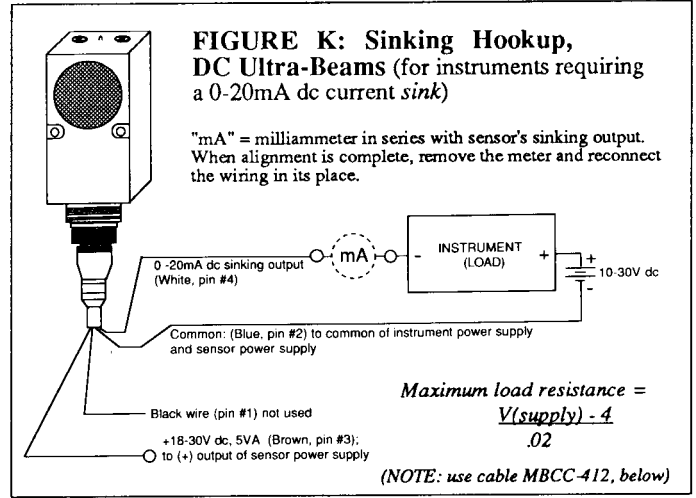
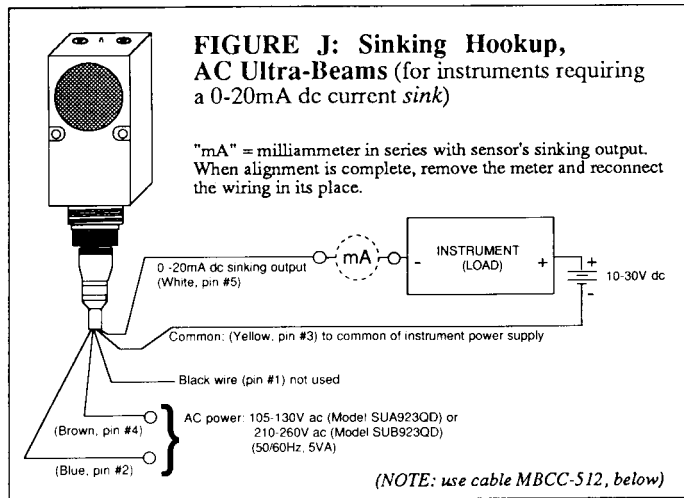

QUICK DISCONNECT ("QD") CABLE: 4- and 5-conductor SO-type cable in 12 foot lengths

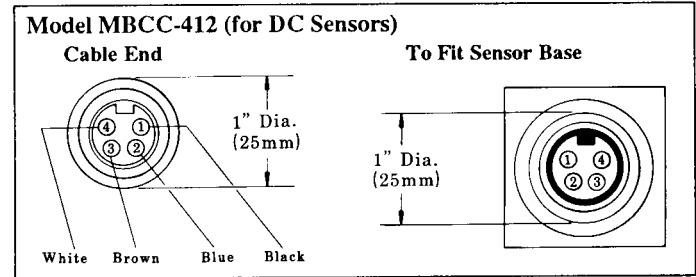
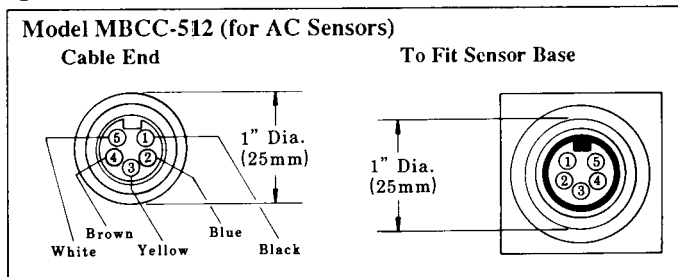

SMB900 MOUNTING BRACKET

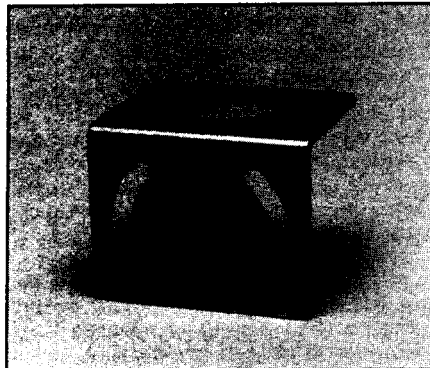

Accessory mounting bracket model SMB900 has curved mounting slots for versatility in mounting and orientation. The sensor mounts to the bracket by its threaded base, using a jam nut and lockwasher (both included). The bracket material is 11-gauge zinc-plated steel. The curved mounting slots have clearance for 1/4" screws.

The internal tooth lockwasher and the hex mounting nut shown in the drawings are supplied with the sensor.

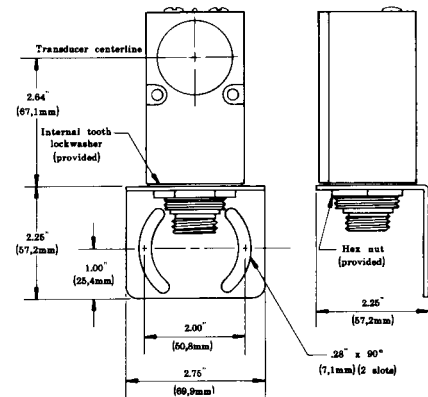

ULTRA-BEAM Ultrasonic Proximity Sensors

925 Series with switched (electromechanical relay) output



Models: **SUA925QD** 105 to 130V ac, 50/60Hz **SUB925QD** 210 to 260V ac, 50/60Hz

Response Pattern

NOTES:

- 1) Response pattern is drawn for the maximum range setting of the ULTRA-BEAM.
- 2) Response pattern is drawn for a 2 square foot solid surface.
- 3) Symmetry of the pattern may be assumed in all sensing planes.
- 4) The rounded portion of the curve past the 20 foot point indicates an area where sensing is unreliable. Effective range is from 20 inches to 20 feet (0,5 to 6 meters).

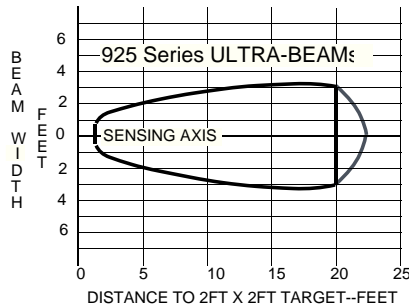

The Banner 925 Series ULTRA-BEAM is an economical ultrasonic sensor with relay output and a sensing range of 20 inches to 20 feet (0,5 to 6 meters). ULTRA-BEAM 925 Series sensors are ideal for long-range proximity requirements which fall beyond the limits of photoelectric response, and are the solution for many applications which require reflective sensing of non-reflective materials. Popular applications include bin-level sensing/control and presence sensing of transparent materials.

Sensing range is easily adjusted using the top-mounted 15-turn clutched range control. When the range is set, objects passing through the sensor's area of response will be reliably sensed from the set range down to 16 inches from the face of the ULTRA-BEAM. The minimum range setting is 20 inches (0,5m). Objects which pass beyond the set range will be ignored. The ULTRA-BEAM has an easily-visible top mounted red LED indicator which lights whenever an object is detected.

For reliable detection, objects to be sensed must present at least one square foot (0,1 square meter) of surface area for each 10 feet of sensor-to-object distance. The response curve (above) illustrates the sensing pattern which results for a 2 square foot target approaching from either side. The pattern is drawn for the maximum range setting of the ULTRA-BEAM. Symmetry of this pattern may be assumed in all sensing planes.

The ULTRA-BEAM is ruggedly constructed with epoxy-encapsulated circuitry and housed in a tough, corrosion-proof VALOX® enclosure. The ultrasonic transducer is protected by a stamped metal screen. The transducer will not be damaged by temporary contact with moisture, but must be kept free of heavy contamination for efficient operation. The output is an SPDT form "C" relay for easy interfacing to most loads (see specifications). An integral 5-pin connector is standard. A mating industrial duty 12 foot cable, model MBCC-512, is sold separately.

Specifications, 925 Series Ultrasonic Sensors with Electromechanical Relay Output

SUPPLY VOLTAGE: model SUA925QD 105 to 130V ac, 50/60Hz; model SUB925QD 210 to 260V ac, 50/60Hz. 6VA.

SENSING RANGE: 20 inches to 20 feet (0,5 to 6 meters). Minimum required target area is 1 square foot (0,1 square meter) for each 10 feet (3 meters) of sensing range.

SENSING HYSTERESIS: 5% of range setting.

RANGE ADJUSTMENT: 15-turn clutched potentiometer with slotted brass element, located under o-ring gasketed access screw on top of sensor. Use small, flat-blade screwdriver to adjust.

INDICATOR LED: red LED indicator on top of sensor lights when object is sensed (when output relay is energized).

RESPONSE TIME: 100 milliseconds ON and OFF.

OUTPUT: one form "C" SPDT relay, silver-nickel alloy contacts.

Capacity: 150 watts or 600VA maximum power (resistive load).

Maximum voltage: 250V ac or 30V dc (resistive load).

Maximum current: 5 amps (resistive load).

Minimum load: 5V dc @ 100 milliamps.

Mechanical life: 10,000,000 operations.

NOTE: install suitable value metal oxide varistor (MOV) across contact(s) used to switch an inductive load.

OUTPUT CONNECTOR: integral threaded 5-pin quick-disconnect. 12-foot mating cable, model MBCC-512, is sold separately (see page 2).

CONSTRUCTION: Epoxy-encapsulated circuitry. Rugged, glass-filled VALOX® housing. NEMA 1, 3, and 12.

OPERATING TEMPERATURE: 0 to 50°C (32 to 122°F).



WARNING These ultrasonic presence sensors do NOT include the self-checking redundant circuitry necessary to allow their use in personnel safety applications. A sensor failure or malfunction can result in *either* an energized or a de-energized sensor output condition.

Never use these products as sensing devices for personnel protection. Their use as safety devices may create an unsafe condition which could lead to serious injury or death.

Only MACHINE-GUARD and PERIMETER-GUARD Systems, and other systems so designated, are designed to meet OSHA and ANSI machine safety standards for point-of-operation guarding devices. No other Banner sensors or controls are designed to meet these standards, and they must NOT be used as sensing devices for personnel protection.

ULTRA-BEAM 925 Series Sensors

Functional Schematic and Hookup Information, 925 Series

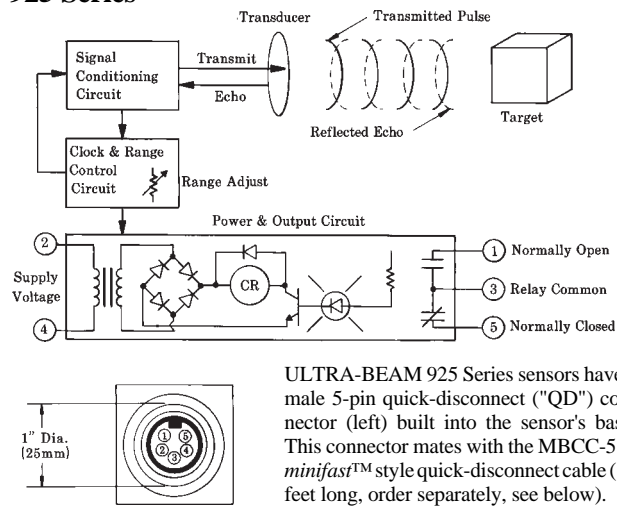

Dimensions, 925 Series Sensors

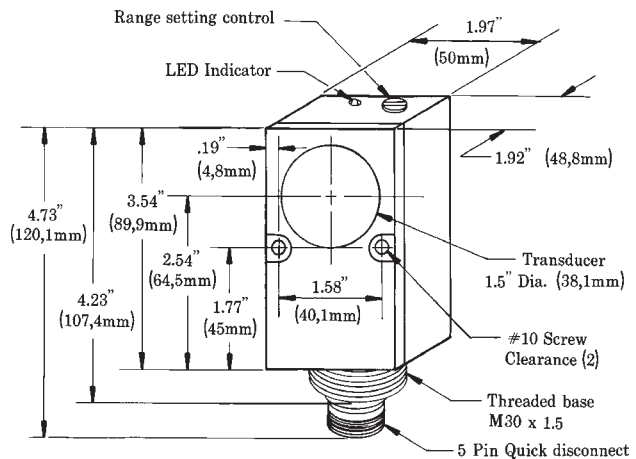

Setup Procedure , 925 Series ULTRA-BEAM Sensors

Proper operation of an ULTRA-BEAM 925 Series sensor requires that it be mounted securely, on a firm surface, at least 24 inches away from side walls. At least 48 inches is required between adjacent ULTRA-BEAMs with parallel sensing beams. Greater separation is required if the sensing beams cross. Less than 48 inches of separation is allowable if the adjacent sensing beams point away from each other.

With the ULTRA-BEAM mounted in place, set the object to be detected at the desired distance, with the surface to be detected directly in front of the sensor and perpendicular to the beam.

Turn the RANGE potentiometer to the fully counterclockwise position, then turn the control clockwise until the sensor's red LED indicator comes on. Verify this range setting by moving the object away from the sensor (LED should go out), then back towards the sensor (LED should come on again at about the same distance as before). It is best to set the range with the object at the maximum distance at which you expect to detect that object.

Minimum target size required for proper operation of the ULTRA-BEAM 925 Series sensor is about 1 square foot for each 10 feet of sensor-to-object distance.

Accessories for 925 Series ULTRA-BEAM Sensors

MBCC-512 *minifast*[™] "QD" Cable (12 feet long)

Connector Side View

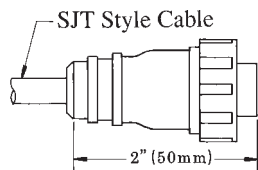

Cable End View (female pins)

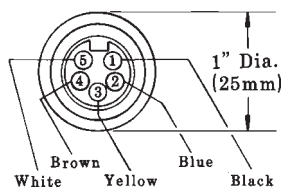

SMB900 Mounting Bracket



SMB900 Mounting Bracket

Accessory mounting bracket model **SMB900** (photo at left and drawing, above right) has curved mounting slots for versatility in mounting and orientation. The sensor mounts to the bracket by its threaded base, using a jam nut and lockwasher (both included). The bracket material is 11-gauge zinc-plated steel. The curved mounting slots have clearance for 1/4" screws.

An internal tooth lockwasher and hex mounting nut are supplied with the sensor.

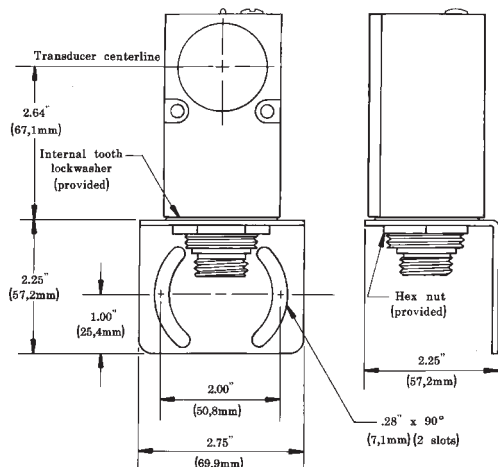

ULTRA-BEAM™ model SU925QD-24

Ultrasonic Proximity Sensor with Switched (Relay) Output



The Banner 925 Series ULTRA-BEAM is an economical ultrasonic sensor with relay output and a sensing range of 20 inches to 20 feet (0,5 to 6 meters). ULTRA-BEAM "925" sensors are ideal for long-range proximity requirements which fall beyond the limits of photoelectric response, and are the solution for many applications which require reflective sensing of non-reflective materials. Popular applications include bin-level sensing/control and presence sensing of transparent materials.

Sensing range is easily adjusted using the top-mounted 15-turn clutched range control. When the range is set, objects passing through the sensor's area of response will be reliably sensed from the set range down to 16 inches from the face of the ULTRA-BEAM. The minimum range setting is 20 inches (0,5m). Objects which pass beyond the set range will be ignored. The ULTRA-BEAM has an easily-visible top mounted red LED indicator which lights whenever an object is detected.



For reliable detection, objects to be sensed must present at least one square foot (0,1 square meter) of surface area for each 10 feet of sensor-to-object distance.

The response curve (above) illustrates the sensing pattern which results for a 2 square foot target approaching from either side. The pattern is drawn for the maximum range setting of the ULTRA-BEAM. Symmetry of this pattern may be assumed in all sensing planes.

The ULTRA-BEAM is ruggedly constructed with epoxy-encapsulated circuitry and housed in a tough, corrosion-proof VALOX® enclosure. The ultrasonic transducer is protected by a stamped metal screen. The transducer will not be damaged by temporary contact with moisture, but must be kept free of heavy contamination for efficient operation. The output is an SPDT form "C" relay for easy interfacing to most loads (see specifications). An integral 5-pin minifast™ connector is standard. A mating industrial duty 12 foot cable, model MBCC-512, is sold separately.

The ULTRA-BEAM is ruggedly constructed with epoxy-encapsulated circuitry and housed in a tough, corrosion-proof VALOX® enclosure. The ultrasonic transducer is protected by a stamped metal screen. The transducer will not be damaged by temporary contact with moisture, but must be kept free of heavy contamination for efficient operation. The output is an SPDT form "C" relay for easy interfacing to most loads (see specifications). An integral 5-pin minifast™ connector is standard. A mating industrial duty 12 foot cable, model MBCC-512, is sold separately.

SU925QD-24 (18 to 30V dc) with electromechanical relay output

Response Pattern

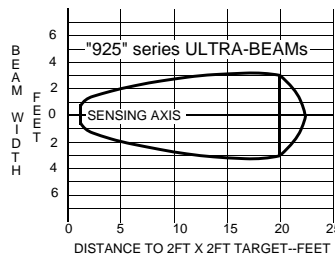

NOTES:

- 1) Response pattern is drawn for the maximum range setting of the ULTRA-BEAM.
- 2) Response pattern is drawn for a 2 square foot solid surface.
- 3) Symmetry of the pattern may be assumed in all sensing planes.
- 4) Rounded portion of curve past the 20 foot point indicates area where sensing is unreliable. Effective range is from 20 inches to 20 feet (0,5 to 6 meters).

Specifications

SUPPLY VOLTAGE: model SU925QD-24, 18 to 30V dc, 4VA

SENSING RANGE: 20 inches to 20 feet (0,5 to 6 meters). Minimum required target area is 1 square foot (0.1 square meter) for each 10 feet (3 meters) of sensing range.

SENSING HYSTERESIS: 5% of range setting.

RANGE ADJUSTMENT: 15-turn clutched potentiometer with slotted brass element, located under o-ring gasketed access screw on top of sensor. Use small, flat-blade screwdriver to adjust.

INDICATOR LED: red LED indicator on top of sensor lights when object is sensed (when output relay is energized).

RESPONSE TIME: 100 milliseconds ON and OFF.

OUTPUT: one form "C" SPDT relay, silver-nickel alloy contacts.

Capacity: 150 watts or 600VA maximum power (resistive load).

Maximum voltage: 250V ac or 30V dc (resistive load).

Maximum current: 5 amps (resistive load).

Minimum load: 5V dc @ 100 milliamps.

Mechanical life: 10,000,000 operations.

NOTE: install suitable value metal oxide varistor (MOV) across contact(s) used to switch an inductive load.

OUTPUT CONNECTOR: integral 5-pin minifast™ threaded quick-disconnect. 12-foot mating cable, model MBCC-512, is sold separately (see information on following page).

CONSTRUCTION: Epoxy-encapsulated circuitry. Rugged, glass-filled VALOX® housing. NEMA 1, 3, and 12.

OPERATING TEMPERATURE: 0 to 50°C (32 to 122°F).



WARNING This ultrasonic sensing device does NOT include the self-checking redundant circuitry necessary to allow its use in personnel safety applications. A sensor failure or malfunction can result in either an energized or a de-energized sensor output condition.

Never use this product as a sensing device for personnel protection. Its use as a safety device may create an unsafe condition which could lead to serious injury or death.

Only MACHINE-GUARD and PERIMETER-GUARD Systems, and other systems so designated, are designed to meet OSHA and ANSI machine safety standards for point-of-operation guarding devices. No other Banner sensors or controls are designed to meet these standards, and they must NOT be used as sensing devices for personnel protection.

ULTRA-BEAM SU925QD-24 Sensor

Functional Schematic and Hookup Information

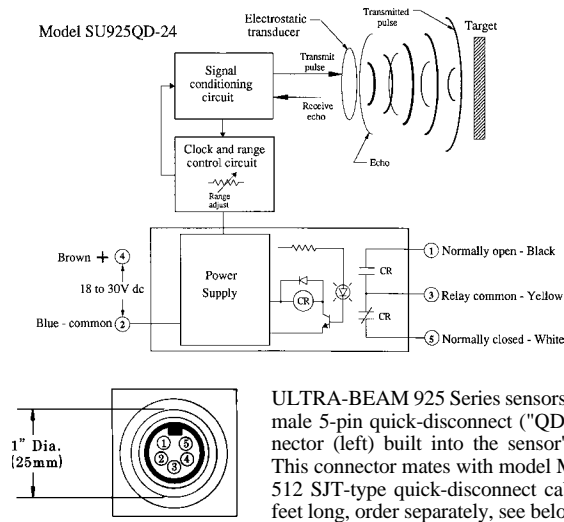

Dimensions, SU925QD-24 Sensors

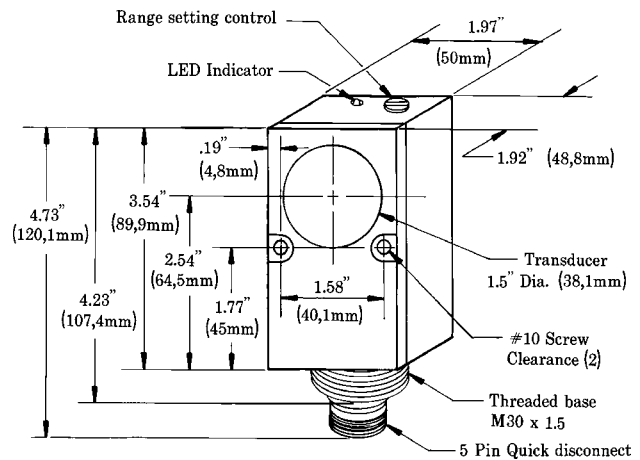

Setup Procedure, SU925QD-24 ULTRA-BEAM Sensors

Proper operation of an ULTRA-BEAM 925 Series sensor requires that it be mounted securely, on a firm surface, at least 24 inches away from side walls. At least 48 inches is required between adjacent ULTRA-BEAMs with parallel sensing beams. Greater separation is required if the sensing beams cross. Less than 48 inches of separation is allowable if the adjacent sensing beams point away from each other.

With the ULTRA-BEAM mounted in place, set the object to be detected at the desired distance, with the surface to be detected directly in front of the sensor and perpendicular to the beam.

Turn the RANGE potentiometer to the fully counterclockwise position, then turn the control clockwise until the sensor's red LED indicator comes on. Verify this range setting by moving the object away from the sensor (LED should go out), then back towards the sensor (LED should come on again at about the same distance as before). It is best to set the range with the object at the maximum distance at which you expect to detect that object.

Minimum target size required for proper operation of the ULTRA-BEAM 925 Series sensor is about 1 square foot for each 10 feet of sensor-to-object distance.

Accessories for 925 Series ULTRA-BEAM Sensors

minifast™ model MBCC-512 Quick Disconnect ("QD") CABLE: 5-conductor SJT-type cable in 12 foot lengths

Cable Connector Side View

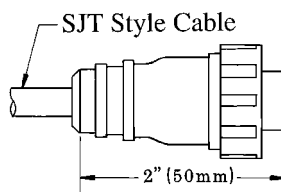

Cable Connector End View

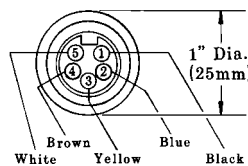

To Fit Sensor Base

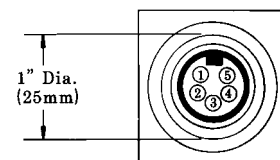

Model SMB900 bracket



Accessory mounting bracket model SMB900 has curved mounting slots for versatility in mounting and orientation. The sensor mounts to the bracket by its threaded base, using a jam nut and lockwasher (both included). The bracket material is 11-gauge zinc-plated steel. The curved mounting slots have clearance for 1/4" screws.

An internal tooth lockwasher and hex mounting nut are supplied with the sensor.

