

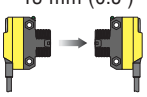
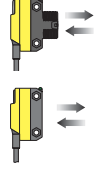
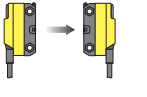
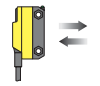
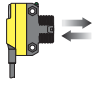
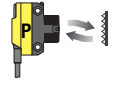
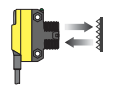
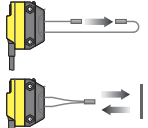
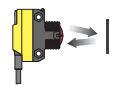
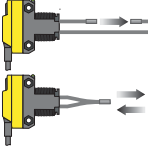

### Features

- Easily fits (or retrofits) almost any mounting situation
- Exceptional optical performance, comparable to larger “MINI-style” or barrel sensors
- 10 to 30V dc operation, with complementary (SPDT) NPN or PNP outputs, depending on model
- Bright LED operating status indicators are visible from 360°
- Rugged sealed housing, protected circuitry
- Models available with or without 18 mm threaded “nose”
- Less than 1 millisecond output response for excellent sensing repeatability
- Choose 2 m (6.5') or 9 m (30') cable or 150 mm (6") Pico-style pigtail QD

### Models

Sensing Mode		Model*	Range	Output	Sensing Mode		Model*	Range	Output
Opposed	940 nm Infrared Effective Beam: 13 mm (0.5") 	QS186E	20 m (66')	N/A	Diffuse		QS18VN6D	450 mm (18")	NPN
		QS18VN6R		NPN			QS18VP6D		PNP
		QS18VP6R		PNP			QS18VN6DB	450 mm (18")	NPN
	940 nm Infrared Effective Beam: 13 mm (0.5") 	QS186EB	3 m (10')	N/A	Divergent		QS18VN6W		100 mm (4")
		QS18VN6RB		NPN			QS18VP6W	PNP	
		QS18VP6RB		PNP			Fixed-Field	660 nm Visible Red 	QS18VN6FF50
660 nm Visible Red 	QS18VN6LP	3.5 m (12')	NPN	QS18VP6FF50	PNP				
	QS18VP6LP		PNP	QS18VN6FF100	100 mm (4")	NPN			
660 nm Visible Red 	QS18VN6LV	6.5 m (21')	NPN	Plastic Fiber Optic					QS18VN6FP
	QS18VP6LV		PNP		QS18VP6FP		PNP		
Convergent	660 nm Visible Red 	QS18VN6CV15	16 mm (0.63")	NPN	Glass Fiber Optic		Range varies by sensing mode and fiber optics used	NPN	
		QS18VP6CV15		PNP					QS18VN6F
		QS18VN6CV45	43 mm (1.7")	NPN				QS18VP6F	
		QS18VP6CV45		PNP					

\* Only standard 2m (6.5') cable models are listed. For 9 m (30') cable, add suffix “W/30” to the model number (e.g., **QS186E W/30**).

**QD models:**

- For 4-pin integral Euro-style QD, add suffix “Q8” (e.g., **QS186EQ8**).
- For 4-pin integral Pico-style QD, add suffix “Q7” (e.g., **QS186EQ7**).
- For 4-pin 150 mm (6") Euro-style pigtail, add suffix “Q5” (e.g., **QS186EQ5**).
- For 4-pin 150 mm (6") Pico-style pigtail, add suffix “Q” (e.g., **QS186EQ**).

# WORLD-BEAM® QS18

## Specifications

<b>Supply Voltage</b>	10 to 30V dc (10% maximum ripple) at less than 25 mA, exclusive of load; Protected against reverse polarity and transient voltages		
<b>Output Configuration</b>	<b>Solid-state complementary (SPDT);</b> NPN or PNP (current sinking or sourcing), depending on model; <b>Rating:</b> 100 mA maximum each output at 25°C <b>Off-state leakage current: FF Mode:</b> less than 200 µA @ 30V dc <b>All others:</b> less than 50 µA @ 30V dc <b>ON-state saturation voltage:</b> less than 1V @ 10 mA; less than 1.5V @ 100 mA Protected against false pulse on power-up and continuous overload or short circuit of outputs		
<b>Output Response</b>	<b>Opposed Mode:</b> 750 microseconds ON; 375 microseconds OFF <b>FF Mode:</b> 850 microseconds ON/OFF <b>All others:</b> 600 microseconds ON/OFF NOTE: 100 millisecond delay on power-up; outputs do not conduct during this time		
<b>Repeatability</b>	<b>Opposed Mode:</b> 100 microseconds <b>FF Mode:</b> 160 microseconds <b>All others:</b> 150 microseconds		
<b>Adjustments</b>	<b>Glass Fiber Optic, Plastic Fiber Optic, Convergent, Diffuse, and Retroreflective mode models (only):</b> Single-turn sensitivity (Gain) adjustment potentiometer		
<b>Indicators</b>	2 LED indicators <b>Green steady:</b> Power ON <b>Yellow* steady:</b> Light sensed <b>*NOTE: Prior to date code 0223, the output indicator was red.</b> <b>Green flashing:</b> Output overloaded <b>Yellow* flashing:</b> Marginal excess gain (1.0 to 1.5x excess gain)		
<b>Construction</b>	ABS housing, rated IEC IP67; NEMA 6 3 mm mounting hardware included		
<b>Connections</b>	2 m (6.5') 4-wire PVC cable 9 m (30') 4-wire PVC cable	4-pin Pico-style QD 4-pin Pico-style 150 mm (6") pigtail QD	4-pin Euro-style QD 4-pin Euro-style 150 mm (6") pigtail QD
<b>Operating Conditions</b>	<b>Temperature:</b> -20° to +70° C (-4° to + 158° F) <b>Relative Humidity:</b> 90% @ 50° C (non-condensing)		
<b>Certifications</b>			

## Dimensions and Features

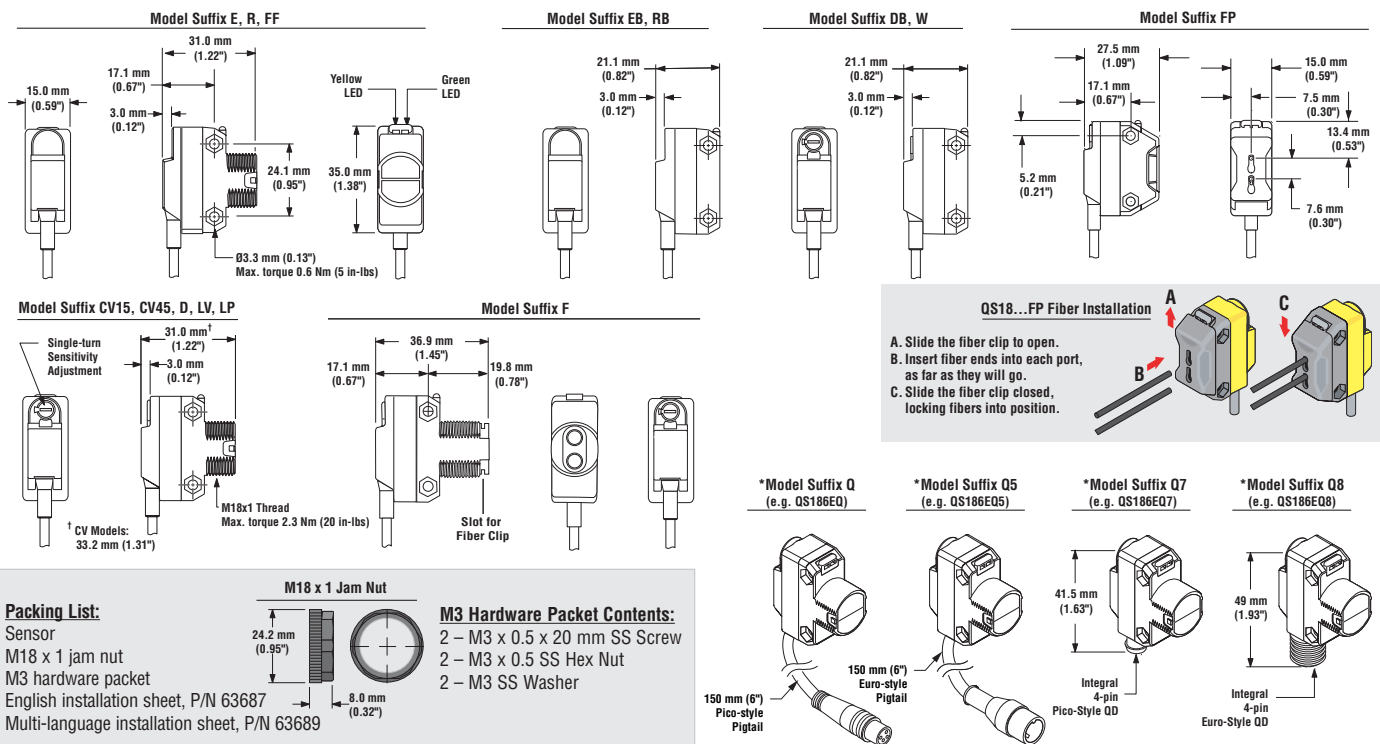

## Performance Curves

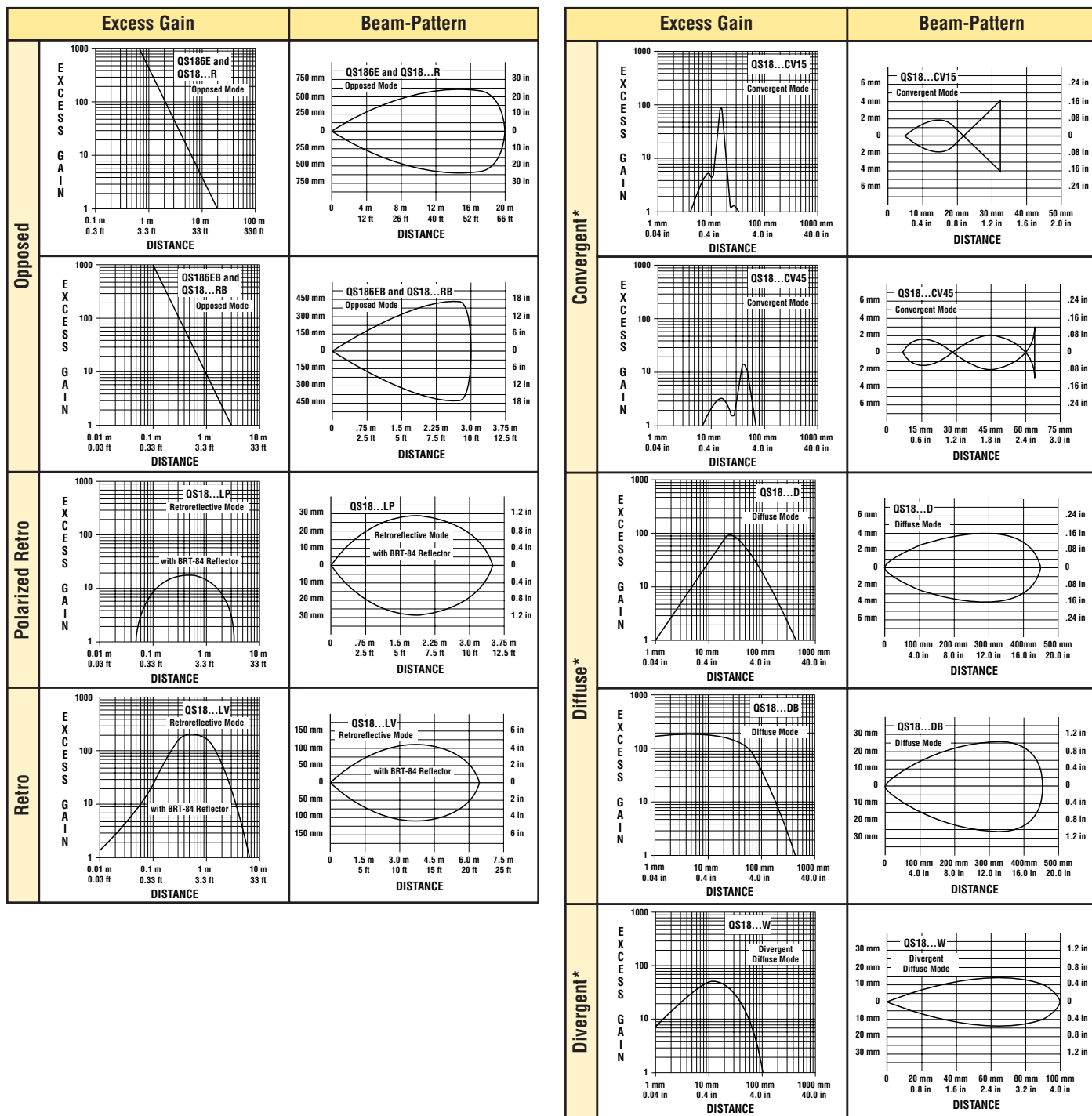

\*Performance based on 90% reflectance white test card

# WORLD-BEAM® QS18

## Performance Curves, continued

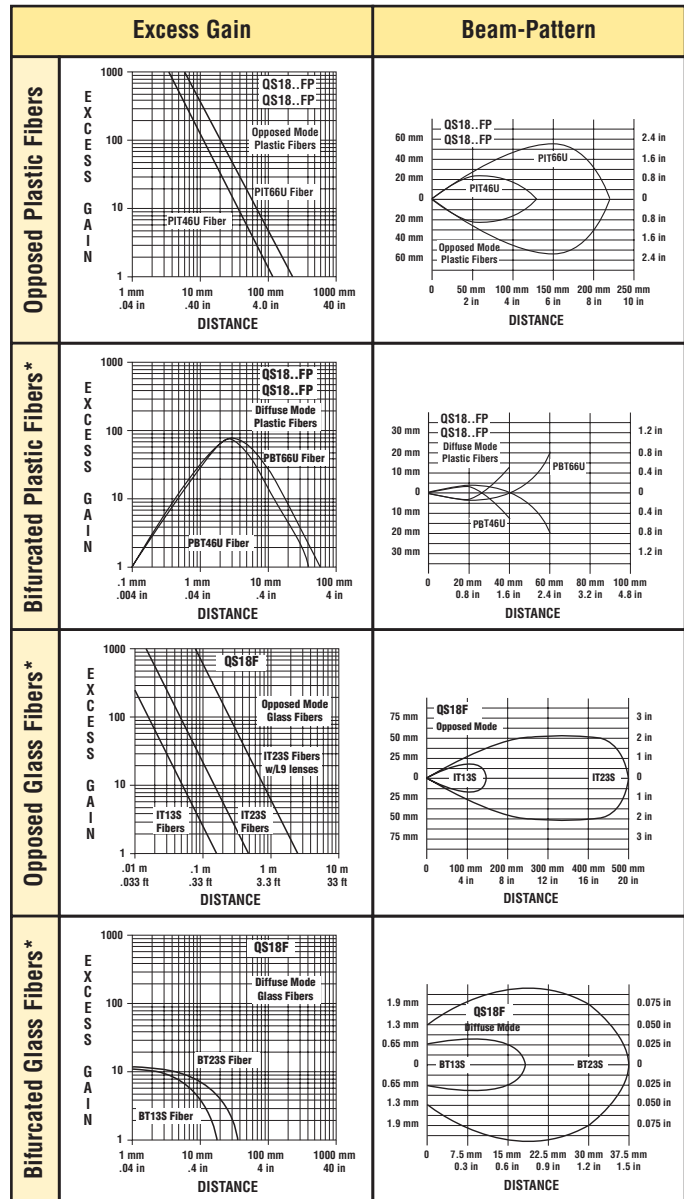
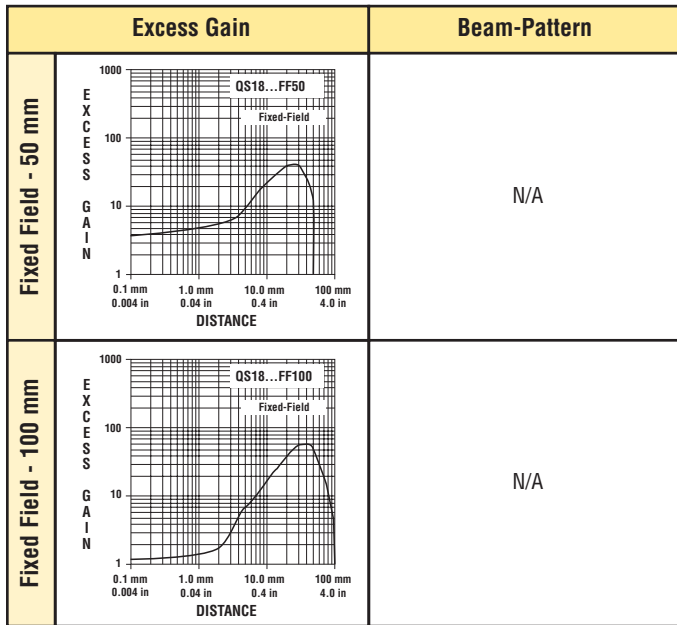

\*Performance based on 90% reflectance white test card

## Hookups

### QS18 Sensors with NPN (Sinking) Outputs

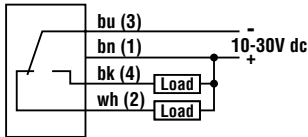

### QS18 Sensors with PNP (Sourcing) Outputs

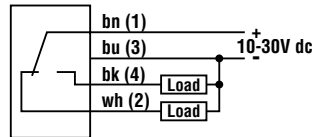

### 4-Pin Pico-Style Pin-out (Cable Connector Shown)

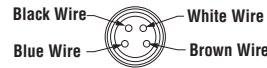

### 4-Pin Euro-Style Pin-out (Cable Connector Shown)

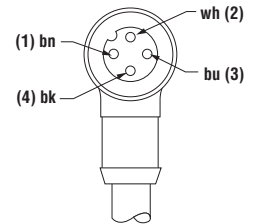

### QS18 Emitters

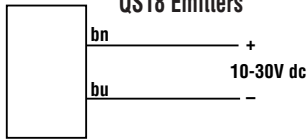

## Installing Fibers

### Unterminated Plastic Fiber Cutting Procedure

Unterminated plastic fibers are designed to be cut by the user to the length required for the application. To facilitate cutting, a Banner model PFC-1 cutting device is supplied with the fiber. Cut the fiber as follows:

- 1) Locate the "control end" of the fiber (the unfinished end). Determine the length of fiber required for the application. If using a bifurcated fiber, separate the two halves of the fiber at least 2" beyond the fiber cutting location. Lift the top (blade) of the cutter to open the cutting ports. Insert one of the control ends through one of the cutting ports on the PFC-1 cutter so that the excess fiber protrudes from the back of the cutter.
- 2) Double-check the fiber length, and close the cutter until the fiber is cut. Using a different cutting port, cut the second control end to the required length. **To ensure a clean cut each time, do not use a cutting port more than once.**
- 3) Gently wipe the cut ends of the fiber with a clean, dry cloth to remove any contamination. **Do not use solvents or abrasives on any exposed optical fiber.**

### Plastic Fiber Installation

- A) Unlock the fiber gripper as shown in Figure 2. If 0.25 mm or 0.5 mm core fibers are being used, slide the small fiber adapters onto the fibers, flush with the fiber ends.
- B) Gently insert the prepared plastic fiber ends into the ports, as far as they will go.
- C) Slide the fiber gripper back to lock, as shown in Figure 2.

### Glass Fiber Installation

- A) Install the O-ring (supplied with the fiber) on each end, as shown in the drawing.
- B) While pressing the fiber ends firmly into the port on the front of the sensor, slide the U-shaped retaining clip (supplied with the sensor) into the slot in the sensor's barrel, until it snaps into place.

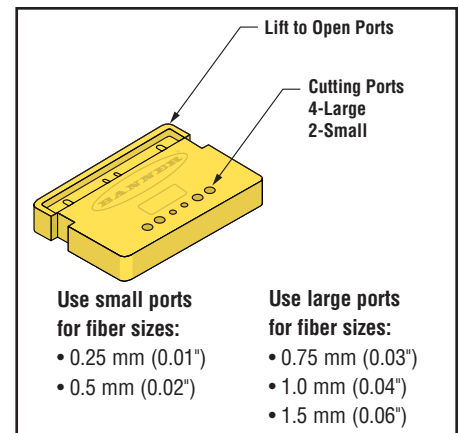

Figure 1. PFC-1 plastic fiber cutter (supplied with fiber)

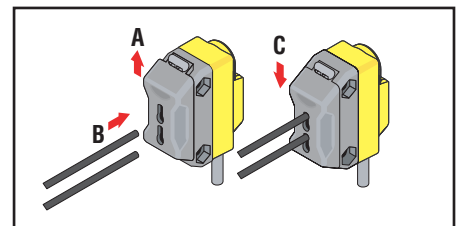

Figure 2. Installing plastic fibers

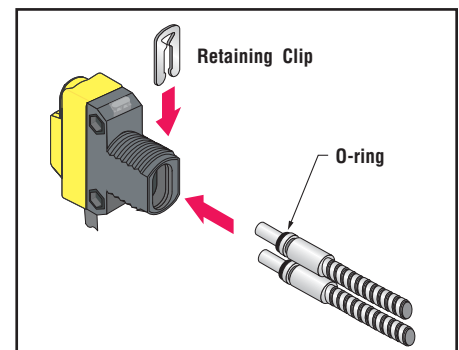

Figure 3. Installing glass fibers

# WORLD-BEAM™ QS18

## Euro-Style Quick-Disconnect Cables

Style	Model	Length	Dimensions
4-Pin Straight	MQDC-406 MQDC-415 MQDC-430	2 m (6.5') 5 m (15') 9 m (30')	
4-Pin Right-angle	MQDC-406RA MQDC-415RA MQDC-430RA	2 m (6.5') 5 m (15') 9 m (30')	

## Pico-Style Quick-Disconnect Cables

Style	Model	Length	Dimensions
4-Pin Straight	PKG4-2	2 m (6.5')	
4-Pin Right-angle	PKW4-2	2 m (6.5')	

## Retroreflective Targets

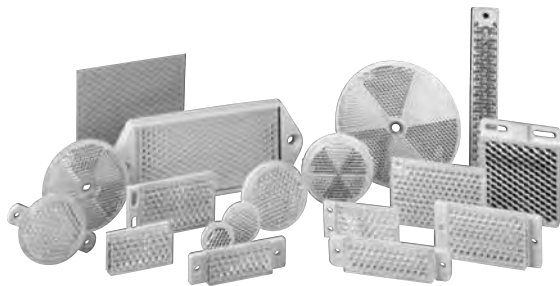

See the Accessories section of your current Banner Photoelectric Sensors catalog for complete information.

NOTE: Polarized sensors require corner cube type retroreflective targets only.

## Plastic and Glass Fiber Optics

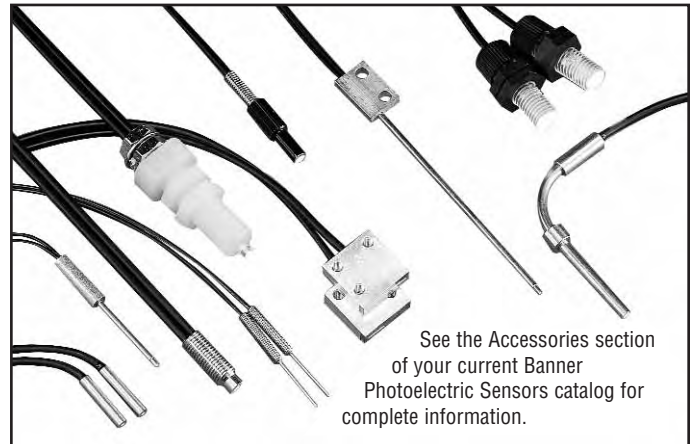

See the Accessories section of your current Banner Photoelectric Sensors catalog for complete information.

## WORLD-BEAM QS18 Mounting Brackets

<p><b>SMB18A</b></p> <ul style="list-style-type: none"> <li>• 12-gauge, stainless steel</li> <li>• Right-angle mounting bracket</li> </ul>	<p><b>SMB312S</b></p> <ul style="list-style-type: none"> <li>• Stainless steel 2-axis, side-mounting bracket</li> </ul>
<p>* Use 4 mm (#8) screws to mount bracket. Drill screw holes 24.2 mm (0.95") apart.</p> <p>Refer to your current Banner Photoelectronics catalog for more mounting bracket options</p>	