

S3 SERIES INSTRUCTION MANUAL

CONTROLS

OUTPUT LED

The red LED indicates the output status.

STABILITY LED (S3-x-A2.5/B2/C10/C50/D12/E1/F5)

The green LED ON indicates that the received signal has a safety margin greater than 30% compared to the output switching value.

TRIMMER (S3-x-A2.5/B2/C10/C50/D12/E1/F5/T0.8)

The trimmer can be used to adjust sensitivity; the operating distance increases turning the trimmer clockwise.

WARNING: The trimmer rotation is limited to 270° by a mechanical stop. Do not apply excessive torque when adjusting (max 40 Nmm).

POWER ON LED (S3-x-G5)

The red LED indicates that the sensor is operating.

LOCK SCREW (S3-x-E1)

The screw is used to correctly lock the fibres. Unscrew before inserting, then screw for final locking.

CONNECTIONS

CABLE VERSIONS

S3-5-A/B/C/D/E/T

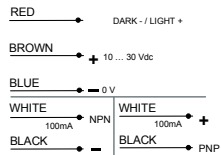

S3-5-G5

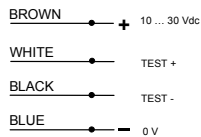

S3-5-F5

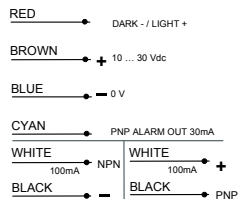

M8 CONNECTOR VERSIONS

S3T-x-A/B/C/D/E/F/T

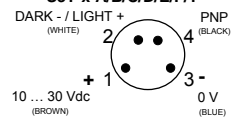

S3T-x-G5

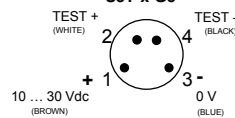

DIMENSIONS

S3-S-A2.5/B2/C10/C50/D12/F5/G5/T0.8

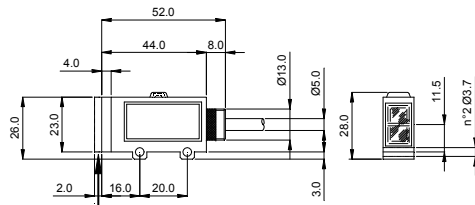

S3T - M8 CONNECTOR

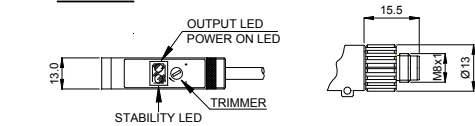

S3-S-E1

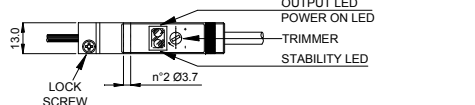
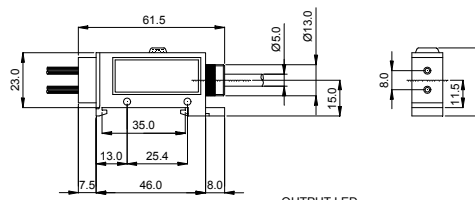

S3-R-A2.5/B2/C10/C50/D12/F5/G5/T0.8

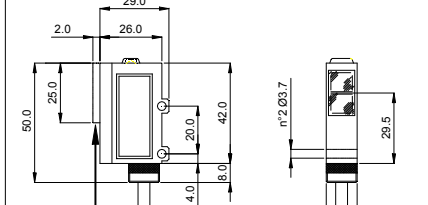

S3T - M8 CONNECTOR

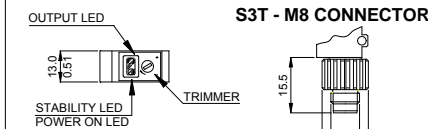

S3-R-E1

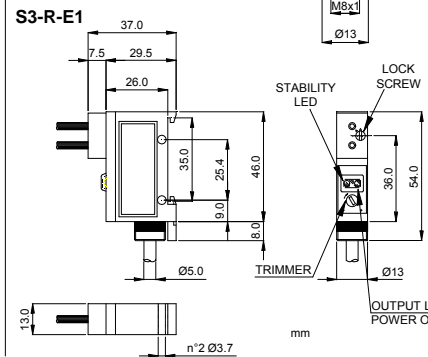

TECHNICAL DATA

Power supply:	10 ... 30 Vdc limit values
Ripple:	2 Vpp max.
Current Consumption (output current excluded):	30 mA max.
Output:	NPN/PNP, 30 Vcc max. vers. S3 / PNP, 30 Vcc max. vers. S3T (short-circuit protection)
Output current:	100 mA max.
Output saturation voltage:	1.5 V max.
Response time:	1 ms max. / 2 ms max. mod. F5/G5
Switching frequency:	500 Hz max. / 250 Hz max. mod. F5/G5
Indicators:	OUTPUT LED (RED) / STABILITY LED (GREEN) / POWER ON LED (RED) mod. G5
Setting:	sensitivity trimmer mod. A2.5/B2/C10/C50/D12/E1/F5/T0.8
Operating temperature:	-25 ... 55 °C
Storage temperature:	-25 ... 70 °C
Electric shock protection:	Class 2
Operating distance (minimum):	T0.8: 0.2 ... 0.8 m on R2 / A2.5: 0.1 ... 2.5 m on R2 / B2: 0.1 ... 2 m on R2 C10: 0 ... 10 cm / C50: 0 ... 50 cm / D12: 10 ... 15 mm F5/G5: 0 ... 5 m E1 (OF-18/22/24): 33 mm / E1 (OF-19/23): 110 mm / E1 (OF-20): 12 mm / E1 (OF-21): 65 mm / E1 (OF-25): 25 mm / E1 (OF-26/28): 5 mm
Emission type:	INFRARED (880 nm) / RED (660 nm) mod. B2/D12/E1/T0.8
Ambient light rejection:	according to EN 60947-5-2
Vibration:	0.5 mm amplitude, 10 ... 55 Hz frequency, for every axis (EN60068-2-6)
Shock resistance:	11 ms (30 G) 6 shock for every axis (EN60068-2-27)
LIGHT/DARK selection:	cable or connector
Housing:	ABS UL 94V-O
Lenses:	PMMA plastic
Protection class:	IP66
Connections:	2 m cable Ø 5 mm vers. S3 / M8 4-pole connector vers. S3T
Weight:	90 g. max. cable versions / 20 g. max. connector versions

SETTING

The following procedures are valid for LIGHT mode operation.

Alignment S3-x-A2.5/B2/T0.8

Position the sensor and reflector on opposite sides. Turn the sensitivity trimmer to maximum. Find the points where the red LED (OUT) is switched ON and OFF in both vertical and horizontal positions, and fix the sensor in the centre between these points. If necessary, reduce sensitivity using the trimmer, in order to detect very small or transparent targets. In order to improve alignment, repeat the procedure detailed above whilst progressively reducing the sensitivity.

Alignment S3-x-F5/G5/E1 (E/R fibres)

Position the sensors on opposite sides. Turn the sensitivity trimmer to maximum. Find the points where the red LED (OUT) is switched ON and OFF in both vertical and horizontal positions, and fix the sensor in the centre between these points. Optimum operation is obtained when both LEDs switch ON. If necessary, reduce sensitivity using the trimmer, in order to detect very small targets. In order to improve alignment, repeat the procedure detailed above whilst progressively reducing the sensitivity.

Alignment S3-x-C10/C50/D12/E1 (proximity fibres)

Position the sensor and turn the sensitivity trimmer at minimum: The green LED is ON and the red LED is OFF. Place the target opposite the sensor. Turn the sensitivity trimmer clockwise until the red LED turns ON. (Target detected state, pos.A). Remove the target, the red LED turns OFF. Turn the trimmer clockwise until the red LED turns ON (Background detected state, pos.B). The trimmer reaches maximum if the background is not detected. Turn the trimmer to the intermediate position C, between the two positions A and B. The green LED must be ON.



TEST FUNCTION (S3/S3T-x-G5)

The TEST+ and TEST- inputs can be used to inhibit the emitter and verify that the system is correctly operating. The receiver output should switch when the test is activated while the beam is uninterrupted. The inputs activating voltage range is 10 ... 30 Vdc, whilst respecting the polarity.

ALARM FUNCTION (S3/S3T-5-F5)

The alarm output switches ON whenever the received signal remains without a safety margin (greater than 30% compared to the output switching level) for longer than 3 seconds.

DECLARATION OF CONFORMITY

We DATALOGIC AUTOMATION declare under our sole responsibility that these products are conform to the 2004/108/CE and successive amendments.



WARRANTY

DATALOGIC AUTOMATION warrants its products to be free from defects.

DATALOGIC AUTOMATION will repair or replace, free of charge, any product found to be defective during the warranty period of 36 months from the manufacturing date.

This warranty does not cover damage or liability deriving from the improper application of DATALOGIC AUTOMATION products.

DATALOGIC AUTOMATION

DATALOGIC AUTOMATION cares for the environment: 100% recycled paper. DATALOGIC AUTOMATION reserves the right to make modifications and improvements without prior notification.

Datalogic and the Datalogic logo are registered trademarks of Datalogic S.p.A. in many countries, including the U.S.A. and the E.U.

8260000623 Rev.C

© Copyright Datalogic 2006-2010