

US30 SERIES - digital output - ultrasonic sensors

INSTRUCTION MANUAL

CONTROLS

Programming push-button (DISCRETE)

This push-button allows to program the reading points of the sensor.

Output configuration push-button (MODE)

This push-button allows to select the output configuration.

POWER LED indicator	Indication
OFF	Power is OFF.
ON Green	Sensor is operating in normal conditions.

OUT LED indicator	Indication
OFF	Target is outside operating field (NO operating mode)
ON Yellow	Target is inside operating field (NO operating mode)

SIGNAL LED indicator	Indication
OFF	Target is outside operating field
Blinking Red	Target is inside operating field

MODE LED indicator	Indication
ON Amber	Indicates selected output configuration (PNP/NPN and NO/NC)

CONNECTIONS

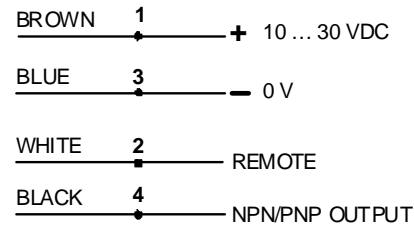

M12 4-POLE CONNECTOR

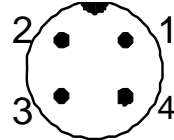

PRINCIPLES OF OPERATION

Ultrasonic sensors emit a series of ultrasonic energy pulses, which travel through the air at the speed of sound. A portion of this energy is reflected by the target and travels back to the sensor. The sensor measures the total time required for the energy to reach the target and return to the sensor. The distance to the object is then calculated using the following formula:

$$D = \frac{ct}{2}$$

D = Distance from the sensor to the target
C = Speed of sound in the air
T = Transit time for the signal

To improve accuracy, an ultrasonic sensor elaborates the average results of several pulses before activating the output.

Temperature effects

The speed of sound depends on the composition, pressure and temperature of the gas in which it is travelling. For most ultrasonic applications, the composition and pressure of the gas are relatively fixed, while the temperature may vary. In air, the speed of sound varies according to the following approximate formulas:

$$C_{m/s} = 20 \sqrt{273 + T_c}$$

C_{m/s} = Speed of sound in meters per second
T_c = Temperature in °C

Temperature Compensation

Changes in air temperature affect the speed of sound, which in turn affects the distance reading measured by the sensor. An increase in air temperature shifts both sensing window limits closer to the sensor. Viceversa, a decrease in air temperature shifts both limits farther away from the sensor. This shift is approximately 3.5% of the limit distance for a 20° C change in temperature. The US30 ultrasonic sensors are temperature compensated. This reduces the error due to temperature by about 90%. The sensor will maintain its window limits to within 2.2% over the -40° to +70°C range.

Notes:
- Exposure to direct sunlight can affect the sensor's ability to accurately compensate for changes in temperature.
- If the sensor is measuring across a temperature gradient, the compensation will be less effective.

TECHNICAL DATA		
	US30-XX-N13	US30-XX-N23
Power supply:	10 ... 30 VDC (Class 2 UL 508) reverse polarity protection	
Ripple:	≤ 2 Vpp	
Consumption (load current excluded):	40 mA max.	
Outputs:	PNP/NPN and N.O./N.C. selectable	
Output current:	100 mA max., short-circuit protection	
Output saturation voltage:	PNP: < 3 V a 100 mA, NPN: < 1.6 V a 100 mA	
Response time:	45 ms	92 ms
Switching frequency:	11 Hz	5.4 Hz
Indicators:	Power on LED (GREEN), Out LED (YELLOW), Signal LED (RED), Output Mode LEDs (YELLOW)	
Setting:	DISCRETE push-button, remote command input (remote teach). Minimum and maximum detection limits can be programmed using the DISCRETE push-button or remote input.	
Remote input levels:	Active: V _{LOW} ≤ 1 V @ 1 mA Disabled: V _{HIGH} ≥ 5V @ 50 uA (leakage current)	
Delay at Power On:	500 ms	
Temperature effect:	0.02% of distance / °C	
Temperature drift:	< 1 % of reading distance	
Repeatability:	0.1 % of distance (0.5 mm min.)	0.1 % of distance (1 mm min.)
Minimum reading window size:	10 mm	
Hysteresis:	2 mm	3 mm
Ultrasonic emission frequency:	224 kHz	174 kHz
Operating temperature:	-40 ... 70 °C	
Storage temperature:	-40 ... 70 °C	
Maximum relative humidity:	95% a 50 °C (without condensation)	
Operating distance (typical values):	100...1000 mm	200...2000 mm
Vibrations:	0.5 mm amplitude, 10...55 Hz frequency, for every axis (EN60068-2-6)	
Shock resistance:	11 ms (30 G) 6 shock for every axis (EN60068-2-27)	
Reference standard:	EN60947-5-2	
Housing material:	PBT polyester	
Push-button material:	Polyester	
Mechanical protection:	IP67	
Connections:	M12 4-pole connector	
Weight:	68 g	

DIMENSIONS

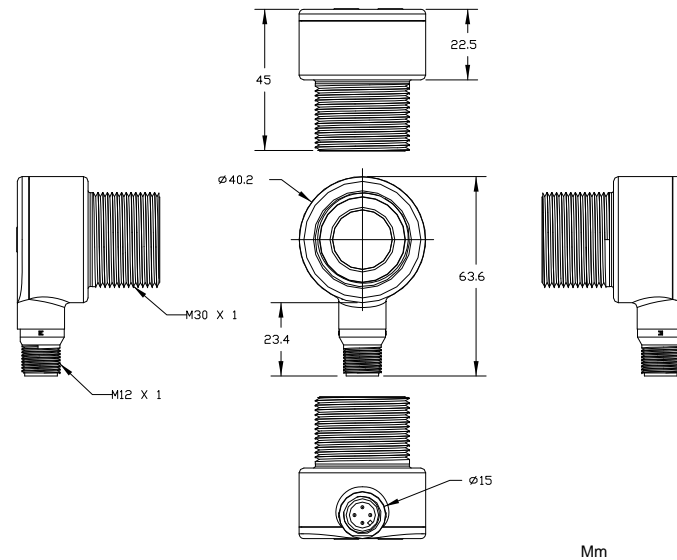

SENSOR PROGRAMMING

Two TEACH methods may be used to program the sensor:

- Detect minimum and maximum limits, or
- Use Auto-Window feature to centre a sensing window around the taught position. This mode is particularly suitable if the sensor is used as background suppression (refer to drawing).

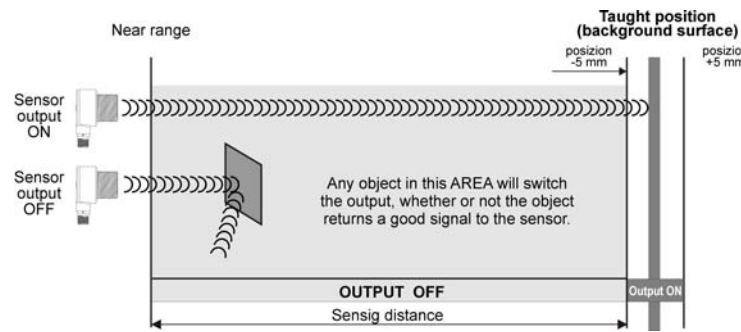

The sensor may be programmed either via DISCRETE push-button, or via a remote command (remote teach). Remote programming may be used to disable the push-button, preventing unauthorized personnel from adjusting the programming settings. To access this feature, connect the Remote Teach wire of the sensor to 0 VDC, with a remote configuration switch between the sensor and the voltage. Programming is accomplished by following the sequence of input pulses. The duration of each pulse (corresponding to a push-button "click"), and the period between multiple pulses, are defined as "T":

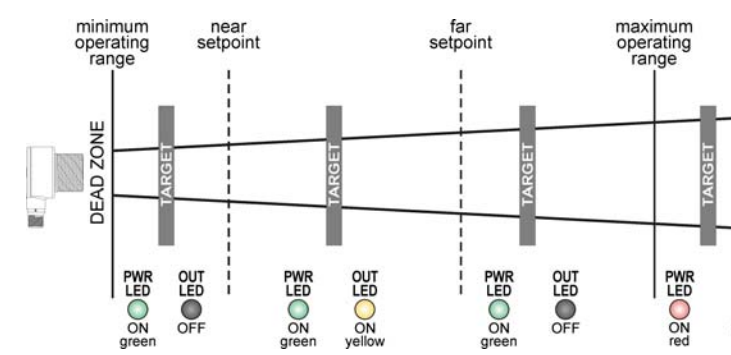

Indication of sensor status and relative signals

Programmazione dei punti di lettura, minimo e massimo, del sensore

	DISCRETE push-button		REMOTE Line	
	Procedure	LED indicators	Procedure	LED indicators
TEACH Mode	Push and hold DISCRETE push-button for >2sec.	LED OUT: ON LED PWR: OFF	No action required. Sensor is ready for 1st limit teach	None.
TEACH First Limit	Position the target for the first limit	LED SIGNAL: must be on or blinking	Position target for the first limit	LED SIGNAL: must be on or blinking
	Press DISCRETE push-button for the first limit	Teach accepted: LED PWR: OFF LED OUT: Blinking Teach not accepted: LED OUT: ON	Single-pulse the remote line (0.04 s < T < 0.8 s)	Teach accepted: LED PWR: OFF LED OUT: Blinking Teach not accepted: LED PWR: ON
TEACH Second Limit	Position the target for the second limit	LED SIGNAL: must be on or blinking	Position target for the second limit	LED SIGNAL: must be on or blinking
	Press DISCRETE push-button for the second limit	Teach accepted: LED PWR: ON LED OUT: ON (depends on the NO or SC mode selected) Teach not accepted: LED PWR: OFF LED OUT: Blinking	Single-pulse the remote line (0.04 s < T < 0.8 s)	Teach accepted: LED PWR: ON LED OUT: ON Teach not accepted: LED PWR: OFF LED OUT: Blinking.

NOTE: the duration of each pulse (remote teach) and the period between multiple pulses are defined as "T" and must be included between 0.04 s and 0.8 s (0.04 s < T < 0.8 s).

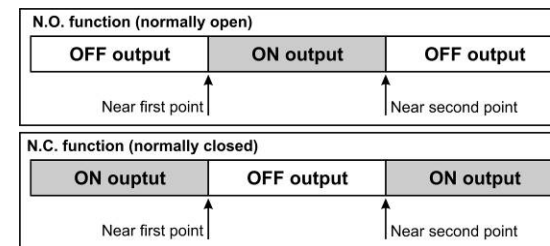

Refer to "NO and NC function selection" chapter

Teaching limits using the Auto-Window feature

Teaching the same limit twice for the same output automatically centres a 100mm window on the taught position (± 50 mm).

	DISCRETE push-button		REMOTE Line	
	Procedure	LED indicators	Procedure	LED indicators
TEACH Mode	Push and hold DISCRETE push-button for >2sec.	LED OUT: ON LED PWR: OFF	No action required. Sensor is ready for 1st limit teach	None
TEACH First Limit	Position the target for the first limit	LED SIGNAL: must be on or blinking	Position target for the first limit	LED SIGNAL: must be on or blinking
	Press DISCRETE push-button	Teach accepted: LED PWR: OFF LED OUT: Blinking Teach not accepted: LED OUT: ON	Single-pulse the remote line (0.04 s < T < 0.8 s)	Teach accepted: LED PWR: OFF LED OUT: Blinking Teach not accepted: LED PWR: ON
Re-TEACH Limit	Press DISCRETE push-button again without moving target	Teach accepted: LED PWR: ON LED OUT: ON o OFF (depends on the NO or SC mode selected) Teach not accepted: LED PWR: OFF LED OUT: Blinking	Pulse again the remote line without moving the target (0.04 s < T < 0.8 s)	Teach accepted: LED PWR: ON LED OUT: ON o OFF (depends on the NO or SC mode selected) Teach not accepted: LED PWR: OFF LED OUT: Blinking

TAUGHT POSITION

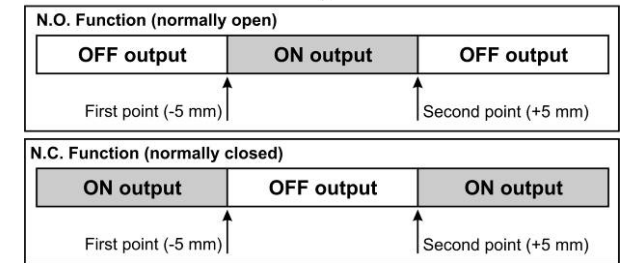

Refer to "NO and NC function selection" chapter

General Notes on Programming

The sensor will return to RUN mode if the first TEACH condition is not registered within 120 seconds. After the first limit is taught, the sensor will remain in PROGRAM mode until the TEACH sequence is finished. To exit PROGRAM mode without saving any changes, press and hold the programming push button > 2 seconds (before teaching the second limit). The sensor will revert to the last saved program.



N.O. (normally open) or N.C. (normally closed) mode selection

The sensor can be configured as NPN or PNP, by choosing between the N.O. and N.C. modes or remote line. A pulse series along this line switches the sensor between N.O. / N.C and PNP / NPN.

- N.O. configuration: sensor output is activated in presence of the target to detect.
- N.C. configuration: sensor output is activated when there is no target to detect.

	MODE push-button		REMOTE Line	
	Procedure	LED indicators	Procedure	LED indicators
TEACH Mode	Push and hold MODE push-button for >2sec	LED PWR: OFF LED MODE: Blinking amber LED shows previously selected mode	Double-pulse the remote line	LED PWR: OFF LED MODE: Blinking amber LED shows previously selected mode
Output selection	Press and hold MODE push-button to select mode in the following sequence: NPN – N.O. NPN – N.C. PNP – N.O. PNP – N.C.	LED PWR: OFF LED MODE: Blinking amber LED shows currently selected mode.	Single pulse: NPN – N.O. Double pulse: NPN – N.C. Triple pulse: PNP – N.O. Four pulses: PNP – N.C.	LED PWR: ON LED MODE: Blinking amber LED shows currently selected mode.
	Save and activate new mode	Push and hold MODE push-button for >2sec	LED PWR: ON LED MODE: Blinking amber LED shows currently selected mode.	None. Sensor exits programming procedure.

Please refer to the document "Sensor Configuration" for advanced functions.

The sensors are NOT safety devices, and so MUST NOT be used in the safety control of the machines where installed.

DECLARATION OF CONFORMITY

We Datalogic Automation declare under our sole responsibility that these products are conform to the 2004/108/CE and successive amendments.

WARRANTY

Datalogic Automation warrants its products to be free from defects. Datalogic Automation will repair or replace, free of charge, any product found to be defective during the warranty period of 36 months from the manufacturing date. This warranty does not cover damage or liability deriving from the improper application of Datalogic Automation products.

DATALOGIC AUTOMATION cares for the environment: 100% recycled paper. DATALOGIC AUTOMATION reserves the right to make modifications and improvements without prior notification.

© 2009 – 2014 Datalogic Automation - ALL RIGHTS RESERVED - Protected to the fullest extent under U.S. and international laws. Copying, or altering of this document is prohibited without express written consent from Datalogic Automation. Datalogic and the Datalogic logo are registered trademarks of Datalogic S.p.A. in many countries, including the U.S.A. and the E.U.