

**BA**

**End stops**

The end stops are mounted at the extremity of the terminal board assembly, giving additional support to the terminal blocks as markers. For various types of marking, refer to the marker section.

**BADL**

Screwless, snaps on rail without tool. V0 grey polyamide for DIN 3 rail. Maintained in place and locked on the rail with metal grips.

To reposition, do not slide on the rail. Withdraw and snap again (screwdriver DIA. 6,5 mm .256" max.)

Thickness: 9 mm .354"

**BADL** grey **0199 408.02**

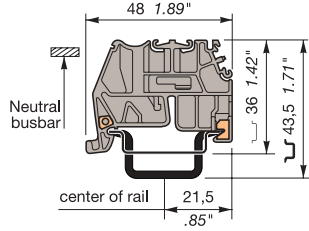
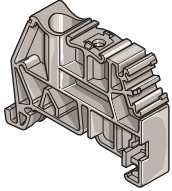

**BAM**

Multi-rail end stop of grey V2 or V0 polyamide equipped with 2 blocking screws allows mounting on PR1, PR3, PR4 and PR5 (DIN 1, DIN 3) rails.

Recommended screwdriver: DIA. 5,5 mm .217"

Recommended torque: Min. 0,8 mN - Max. 1 mN

Min. 7.1 lb.in - Max. 8.9 lb.in

Thickness: 9,1 mm .358"

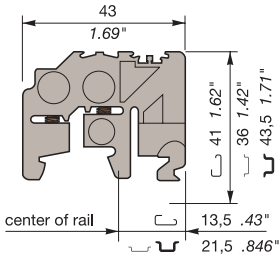
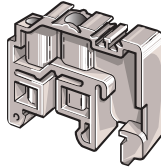

**BAM** grey **0103 002.26**

**BAM V0** beige **0199 306.03**

**BAMH**

Multi-rail end stop of V2 or V0 polyamide equipped with 2 blocking screws allows mounting on PR1, PR3, PR4 and PR5 (DIN 1, DIN 3) rails.

Suitable for double deck blocks.

Recommended screwdriver: DIA. 5,5 mm .217"

Recommended torque: Min. 0,8 mN - Max. 1 mN

Min. 7.1 lb.in - Max. 8.9 lb.in

Thickness: 9,1 mm .358"

**BAMH** grey **0114 836.00**

**BAMH V0** beige **0194 836.01**

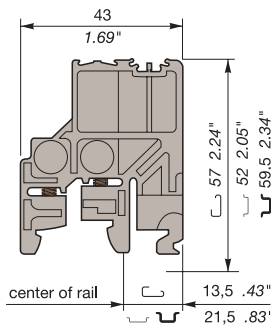

**BAR**

Reversible end stop of beige polyamide with blocking bracket. To be mounted vertically or at a 30° angle, on PR1 rail only.

Thickness: 10 mm .394"

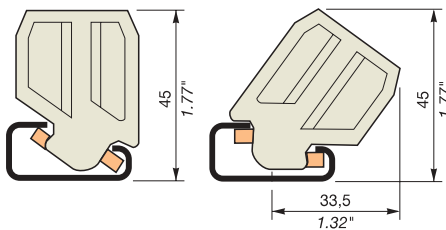

**BAR** beige **0164 519.24**

**BADH, BAEH**

Tall end stop of polyamide, for use with M 70/22, M 95/26 blocks, power blocks, double or triple deck blocks, and electronic interface modules series 7 000, 8 000, 10 000, 11 000 and 30 000.

Snaps on rail - Easy mounting and repositioning, even between 2 blocks.

Recommended screwdriver: DIA. 5,5 mm .217"

Recommended torque: Min. 1,2 Nm - Max. 1,4 Nm

Min. 10.6 lb.in - Max. 12.3 lb.in

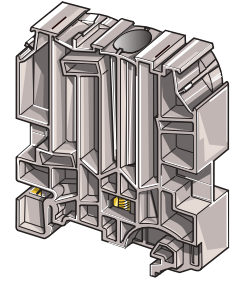

Thickness: 12 mm .472"

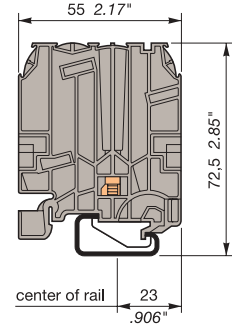
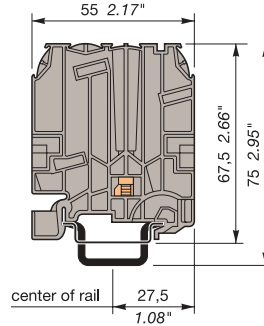

**BADH** grey **0116 900.27**

**BAEH** grey **0116 934.04**

**BAEH** beige **0196 934.05**

**BADRL**

End stop of V0 grey polyamide snaps on DIN 2 rail, automatically maintained in place with metal grips.

To reposition, do not slide on the rail. Withdraw and snap again (screwdriver DIA. 4 mm .157" max.)

Thickness: 6,5 mm .256"

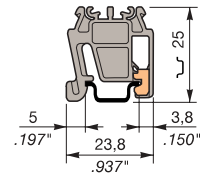
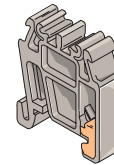

**BADRL** grey **0199 420.21**

**BAH11**



To be mounted on symmetrical rail type 1 12,2 x 5,1 mm .480 x .201", according to NFC 93 461 standard.

Thickness: 7,1 mm .280"

**BAH11** **0164 659.10**

**BAH21**



To be mounted on strengthened symmetrical rail type 2 only: 21,8 x 8,2 mm .858 x .323", according to NFC 93 461 standard.

Thickness: 7,1 mm .280"

**BAH21** **0167 489.22**

**BAH22**

To be mounted on strengthened symmetrical rail type 2 only 21,8 x 8,2 mm .858 x .323", according to NFC 93 461 standard.

Thickness: 7,1 mm .280"

**BAH22** **0164 655.04**



**BAH24**

To be mounted on strengthened symmetrical rail type 2 only 21,8 x 8,2 mm .858 x .323", according to NFC 93 461 standard.

Thickness: 7,1 mm .280"

**BAH24** **0168 355.13**



# FE End sections

When assembled on the mounting track, terminal blocks cover each other's open side. At the end of an assembly, or when the size of the blocks change in an assembly, an end section must be used to isolate the open side of the block. End sections are available for all terminal blocks and are sometimes available in colors. Colored end sections can offer an easy and economical way to separate circuits for identification.

## Snap-on end sections for blocks

End sections below are aligned with the profile of the block and snap on the open side of the block.

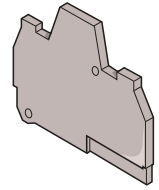
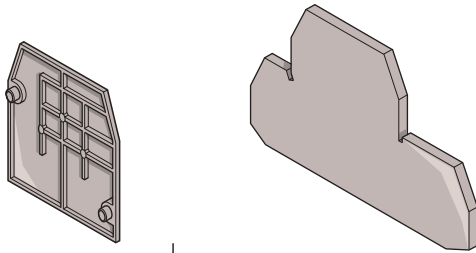

## Specific end sections for A.D.O. terminal blocks

Type	Thickness	P/N
Blocks	Color	
<b>FEM6</b>	2,8 mm .110"	
MA 2,5/5 except D	grey	0118 368.16
M 4/6 except D and G	white	0103 312.20
M 4/6...	blue	0128 368.10
M 4/6.H and M1	yellow	0103 062.21
M 1,5/6.HH and ADV	green	0103 125.15
MTC 6	orange	0103 126.16
M 6/8 and M 10/10	black	0107 005.25
<b>FEMS6</b>	3 mm .118"	
MS 4/6...	grey	0113 885.01
	blue	0123 885.03
	yellow	0103 300.11
	orange	0103 292.25
<b>FEMS8</b>	3 mm .118"	
MS 6/8...	grey	0114 195.06
	blue	0124 195.00
	yellow	0103 301.06
	orange	0103 302.07
<b>FEM3A</b>	3 mm .118"	
M 4/6.3A	grey	0116 576.15
	blue	0126 576.17
	yellow	0103 862.20
<b>FEM4A</b>	3 mm .118"	
M 4/6.4A	grey	0116 629.22
M 4/6.SNBT.4A	blue	0126 629.24
	yellow	0103 863.21
<b>FEM6D</b>	1 mm .039"	
MA 2,5/5.D	grey	0118 499.23
M 4/6.D	blue	0128 499.25
M 4/6.D2.H		
M 1,5/6.D2.HH		
M 4/6.D2.M		
<b>FEM61D</b>	3 mm .118"	
M 4/6.D2.G and 2G	grey	0114 815.03
<b>FEM62</b>	3 mm .118"	
M 4/6.SB	grey	0114 994.07
M 4/6.SNB	orange	0103 612.25
<b>FEM62D</b>	3 mm .118"	
MS 4/6.D2.2G	grey	0114 429.10
<b>FEM6G</b>	2,5 mm .098"	
M 2,5/6.2G	grey	0113 027.07
M 4/6.G and 2G	blue	0123 027.01
<b>FEM8</b>	3 mm .118"	
M 6/8.S and SB	grey	0113 373.26
M 6/8.SN	orange	0103 230.02
<b>FEM8D2S</b>	1,5 mm .059"	
M 4/8.D2.SF	grey	0116 913.07
<b>FEM8S</b>	1,5 mm .059"	
M 4/8.SF	grey	0116 951.15
M 4/8.SN	orange	0103 923.15
M 4/8		
<b>FEM9</b>	3 mm .118"	
M 6/9.EE	grey	0113 067.17
<b>FEM12</b>	3 mm .118"	
M 16/12	grey	0118 618.01
	blue	0128 618.03
	yellow	0103 065.24

Type	Thickness	P/N
Blocks	Color	
<b>FEM12F</b>	3 mm .118"	
M 6/12.FF	white	0114 023.04
<b>FEM12N</b>	1 mm .039"	
M 16/12.NT	blue	0128 616.21
<b>FEM12S</b>	3 mm .118"	
MB 10/12.SF	grey	0117 628.22
<b>FEM13U</b>	1,5 mm .059"	
ML 10/13.SF	black	0199 635.24
ML 10/13.SN		
MU 10/13.SF		
<b>FEM13F</b>	1 mm .039"	
M 6/13.FF	grey	0116 977.17
<b>FEM16</b>	3 mm .118"	
M 35/16	grey	0118 233.27
	blue	0128 233.21
	yellow	0103 061.20
<b>FEM22</b>	3 mm .118"	
M 70/22	grey	0113 065.15
	yellow	0103 881.14
<b>FEMG</b>	1,5 mm .059"	
M 4/6.3G	grey	0114 144.12
M 4/6.5.3G		
M 2,5/6.4G		
M 2,5/6.5.4G		
<b>FEMR10</b>	2,5 mm .098"	
M 10/10.RS	grey	0114 434.05
<b>FEMT1</b>	2,8 mm .110"	
M 6/8.STP	grey	0113 137.02
<b>FEMT2</b>	1 mm .039"	
M 6/8.ST	grey	0113 629.27
<b>FEMT3</b>	2,5 mm .098"	
M 4/6.ST	grey	0114 328.22
<b>FEMT4</b>	3 mm .118"	
M 6/8.STA	grey	0114 778.05
<b>FEMSTA</b>	3 mm .118"	
M 6/8.STA	grey	0116 979.21
<b>FEMR8</b>	2,8 mm .110"	
M 6/8.RS	grey	0116 987.02
<b>FEMR8T</b>	2,8 mm .110"	
M 6/8.STP.RS	grey	0116 991.06
<b>FEM8D1</b>	1 mm .039"	
M 6/8.D...	grey	0116 656.25
<b>FEM8D2</b>	4 mm .157"	
M 6/8.D...	grey	0116 657.26
<b>FEM12N</b>	1 mm .039"	
M 16/12.NT	blue	0128 616.21
<b>FEMS6D</b>	1 mm .039"	
M 4/6.D2.SNBT	grey	0116 591.05
<b>FEMT5</b>	2,5 mm .098"	
M 10/10.St.Sn	grey	0116 781.13
<b>FED3E</b>	3 mm .118"	
D 2,5/6.D	grey	0116 771.20
<b>FED6</b>	1 mm .039"	
D 4/6...	grey	0116 964.12
<b>FEDA6</b>	1 mm .039"	
D 4/6.A...	grey	0116 965.13

## End sections V0

Type	Thickness	P/N
Blocks	Color	
<b>FEM3AP V0</b>	3 mm .118"	
M 4/6.3A.P V0	yellow	0199 876.26
<b>FEM4AP V0</b>	3 mm .118"	
M 4/6.4A.P V0	yellow	0199 879.01
<b>FEM6 V0</b>	2,5 mm .098"	
M 4/6 V0	beige	0198 368.17
M 6/8 V0	blue	0199 302.07
M 10/10 V0	yellow	0199 305.02
MA 2,5/5 V0		
<b>FEM3A V0</b>	3 mm .118"	
M 4/6.3A V0	beige	0196 576.16
<b>FEM4A V0</b>	3 mm .118"	
M 4/6.4A V0	beige	0196 629.23
M 4/6.SNBT.4A V0		
<b>FEM62 V0</b>	3 mm .118"	
M 4/6.SB V0	beige	0194 994.00
<b>FEM6D V0</b>	1 mm .039"	
M 4/6.D V0	beige	0198 499.24
MA 2,5/5.D2 V0		
<b>FEM6G V0</b>	2,5 mm .098"	
M 2,5/6.2G.2G V0	beige	0193 027.00
M 4/6.2G V0		
<b>FEM8 V0</b>	3 mm .118"	
M 6/8.S V0	beige	0193 373.27
M 6/8.SN V0		
<b>FEMT3 V0</b>	2,5 mm .098"	
M 4/6.ST	beige	0194 328.23
<b>FEM8D2S V0</b>		
M 4/8.D2.SF	beige	0196 913.00
<b>FEMR8 V0</b>	2,8 mm .110"	
M 6/8.RS V0	beige	0196 987.03
<b>FEMR8T V0</b>	2,8 mm .110"	
M 6/8.STP.RS V0	beige	0196 991.07
<b>FEMR10 V0</b>		
M 10/10.RS V0	beige	0194 434.06
<b>FEM8S V0</b>	1,5 mm .059"	
M 4/6.SF V0	beige	0196 951.16
M 4/6.SN V0		
<b>FEM12 V0</b>	3 mm .118"	
M 16/12 V0	beige	0198 618.02
M 16/12.N V0	blue	0199 303.00
<b>FEM12F V0</b>	3 mm .118"	
M 6/12.FF V0	beige	0114 023.04
<b>FEM13F V0</b>	1 mm .039"	
M 6/13.FF V0	beige	0196 977.17
<b>FEM16 V0</b>	3 mm .118"	
M 35/16 V0	beige	0198 233.20
M 35/16.N V0	blue	0199 304.01
<b>FEM22 V0</b>	3 mm .118"	
M 70/22 V0	beige	0193 065.16
<b>FEMT2 V0</b>	1 mm .039"	
M 6/8.ST V0	beige	0193 629.20
<b>FEMS6 V0</b>	3 mm .118"	
MS 4/6	beige	0193 885.02
<b>FEM8D1 V0</b>	1 mm .039"	
M 6/8.D2	beige	0196 656.26
<b>FEMT5 V0</b>	2,5 mm .098"	
M 10/10.St.Sn	beige	0196 781.14

Type	Thickness	P/N
Blocks	Color	
<b>FEDAD1</b>	3 mm .118"	
D 2,5/5...ADO	grey	0199 336.20
D 4/6...ADO	grey	0199 339.03
D 6/8...ADO	yellow	
D 6/8...ADO3		
<b>FEDAD4</b>	2 mm .079"	
D 4/6.S...ADO	grey	0199 352.00
D 4/8.S...ADO		
<b>FEDAD5</b>	2 mm .079"	
D 1,5/6.S...ADO	grey	0199 354.02
D 2,5/8.S...ADO		
<b>FEDAD6</b>	1,5 mm .059"	
D 4/8.SF...ADO...	grey	0199 356.04
D 4/8.SNN...ADO...		
<b>FEDAD7</b>	1,5 mm .059"	
D 1,5/8.S...ADO	grey	0199 382.27
D 2,5/8.S...ADO2		
<b>FEMAD3</b>	3 mm .118"	
D 1/5...ADO	grey	0199 341.05
D 1,5/6...ADO	yellow	0199 343.07
D 2,5/8...ADO		
D 4/8...ADO		
<b>FED2AD1</b>	5 mm .196"	
D 4/6.D2.ADO	grey	0199 417.12
D 4/6.D2.ADO.1		
<b>FED2AD2</b>	5 mm .196"	
D 1,5/6.D2.ADO	grey	0199 476.25

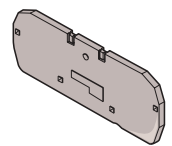

## Specific end sections for spring connection terminal blocks

Type	Thickness	P/N
<b>FED1.L V0</b>	1,5 mm .059"	
DR 2,5/5...2L	grey	0291 301.02
DR 2,5/10...4L	orange	0291 302.03
DS 2,5/5...2L		
DS 2,5/10...4L		
<b>FED5.2L V0</b>	2,5 mm .098"	
D 2,5/5...2L	grey	0291 061.24
D 4/6...2L	orange	0291 062.25
<b>FED5.3L V0</b>	2,5 mm .098"	
D 2,5/5...3L	grey	0291 051.22
	orange	0291 052.23
<b>FED5.4L V0</b>	2,5 mm .098"	
D 2,5/5...4L	grey	0291 041.20
D 2,5/5.2L.2L	orange	0291 042.21
<b>FED8.2L V0</b>	2,5 mm .098"	
D 6/8...2L	grey	0291 161.25
	orange	0291 162.26
<b>FED8SF.2L V0</b>	3 mm .118"	
D 2,5/8.S...2L	grey	0291 131.17
	orange	0291 132.10

## FE End sections (cont.)

### Rail mounted end sections

#### FEM61

This end section mounts on the rail next to the open side of the block. It does not snap on the block itself.

This end section is aligned with the blocks:



- MA 2,5/5
- M 4/6
- M 6/8
- M 10/10
- M 4/6.NT
- M 6/8.NT
- M 10/10.NT
- M 4/6.SNT

Thickness: 3 mm .12"

**FEM61**

**0114 776.23**

#### FEM6C

This end section mounts on the rail next to the open side of the block and offers the possibility of protecting or identifying the assembly with a cover type CPM and a marker-holder type PEP. An end section is advised every foot for support of the cover.

This end section is aligned with the blocks:



- MA 2,5/5
- M 4/6
- M 6/8
- M 10/10
- M 4/6.NT
- M 6/8.NT
- M 10/10.NT
- M 4/6.SNT

Thickness: 3 mm .12"

**FEM6C**

**0114 777.24**

#### FEH

### Two types of end section:

1 For stud terminal blocks of HD type..., and various blocks, a special closing section must be used for one of the two end elements.

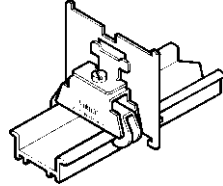

<b>FEH3</b>	th. 1 mm (.040")	<b>0198 352.07</b>
<b>FEH4</b>	th. 1 mm (.040")	<b>0193 878.22</b>
<b>FEHD1</b>	th. 1 mm (.040")	<b>0199 400.06</b>
<b>FEH7</b>	th. 1 mm (.040")	<b>0197 222.14</b>
<b>FEH8</b>	th. 1,5 mm (.059")	<b>0198 729.01</b>
<b>FEH9</b>	th. 1,6 mm (.063")	<b>0198 549.05</b>

2 For the other blocks, a flange must be placed at each end of the terminal block in order to conserve insulation between the blocks and the metal stops. This flange can hold a CP cover, together with a PEF terminal block identification door. It determines the height of the assembly: 31.8 mm or 40 mm or 50.5 mm (1.25" or 1.57" or 1.99")

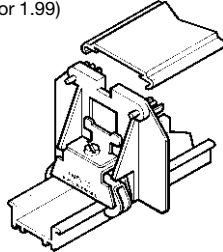

<b>FEH2</b>	th. 3 mm (.118")	<b>0193 472.13</b>
<b>FEH2</b>	th. 3 mm (.118")	<b>0199 395.24</b>
	yellow	
<b>FEH6</b>	th. 3 mm (.118")	<b>0198 059.05</b>
<b>FEH6</b>	th. 3 mm (.118")	<b>0199 392.21</b>
	yellow	

## FJ Separator end section

This is used to hold a cover in the middle of the terminal block. Like the FEH, it determines the height of the assembly: 31,8 mm, 40 mm, or 50.5 mm (1.25", 1.57", or 1.99"). Using this makes it unnecessary to use an SC separator, but requires the presence of FEH at the end of the terminal blocks.

Intermediate flange without changing the assembly height.

### For assembly height 31.8 mm (1.25")

th. 3,6 mm (.142")

**FJH32** **0193 151.11**

**FJH32** **0199 406.20**

yellow

### For assembly height 40 mm (1.57")

th. 3mm (.118")

**FJH40** **0199 401.23**

### For assembly height 50 mm (1.97")

th. 3 mm (.118")

**FJH50** **0193 495.03**

### For assembly height 55 mm (2.16")

th. 1,5 mm (.059")

**FJH50** **0193 495.03**

Intermediate flange changing the height 40 mm / 50 mm (1.57" / 1.97").

th. 3 mm (.118")

**FJDH** **0193 496.04**

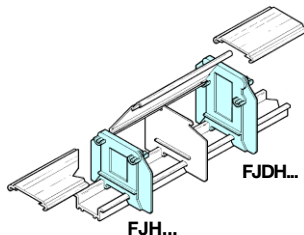

## SC Circuit separator and separator end section

The body of standard terminal blocks, series 5 000, is open in the central upper part for the passage of the jumper bar..

In order to maintain clearance between 2 open blocks equipped with test sockets or between two series of open blocks equipped with jumper bars of different potential, the insulator opening must be covered by a circuit separator.

### Circuit separator

#### SCM

An SCM separator snaps onto the top of the open terminal blocks, once the terminal board is assembled.

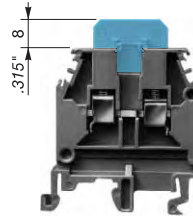

This accessory does not increase the thickness of the block.

### For M 2,5/5 blocks

**SCM5** *grey* **0113 001.16**

*blue* **0123 001.10**

### For M 2,5/5 V0 blocks

**SCM5 V0** *beige* **0196 728.26**

### For MA 2,5/5 blocks

**SCMA5** *grey* **0116 728.25**

### For MA 2,5/5.D blocks

**SCMA5D** *grey* **0116 720.21**

### For M 1,5/6.HH and ADV blocks, M 4/6, M 6/8, M 10/10, M 16/12 blocks

**SCM6** *grey* **0113 003.10**

*blue* **0123 003.12**

*yellow* **0103 020.23**

*orange* **0103 233.21**

*green* **0103 234.22**

### For M 4/6 V0, M 6/8 V0, M 10/10 V0, M 16/12 V0 blocks

**SCM6 V0** *beige* **0193 003.11**

### For M 4/6.D blocks

**SCM6D** *grey* **0113 482.05**

### For M 4/6.D V0 blocks

**SCM6D V0** *beige* **0193 482.06**

### For ADO blocks

**SCAD** *grey* **0196 896.00**

#### SCD

Separator for use with LNTP blocks only. It is snapped onto the extremity of the BJM62 connector bars before they are mounted on the blocks.



**SCD** *white* **0103 189.26**

#### SCH

A separator inserted between two terminal blocks ensures lateral insulation or increases leakage lines between respective conducting parts.

When mounted with the cover, the SC acts as a reinforcement to the cover, since it corresponds to the assembly height.

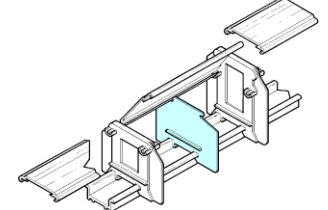

### For mounting with HD type block

th. 1,6 mm (.062")

**SCH3** **0198 692.25**

th. 4 mm (.157")

**SCH6** **0199 393.22**

### For assembly height 31.8 mm (1.25")

th. 1 mm (.039")

**SCH1** **0193 251.25**

**SCH1** **0199 407.21**

yellow

### For assembly height 40 mm (1.57")

th. 1,2 mm (.047")

**SCH2** **0198 650.16**

**SCH2** **0199 389.06**

yellow

### For assembly height 50.5 mm (1.99")

th. 1,2 mm (.047")

**SCH5** **0198 060.02**

### For assembly height 57 mm (2.24")

with HD type block

th. 1,2 mm (.047")

**SCH8** **0199 412.15**

# SC Circuit separator and separator end section (cont.)

## Separator end section

### Snap-on end sections for blocks / separators

#### SCF

An SCF separator is snapped onto the terminal block before mounting on the rail. It can also be used as an end section.

✓ Allows mounting of a protective cover CPM, and a marker-holder PEP.

✓ Allows marking, by the user, on the back of the separator.

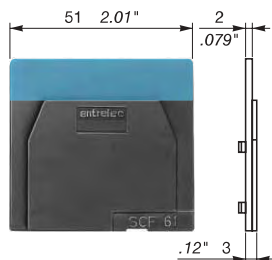
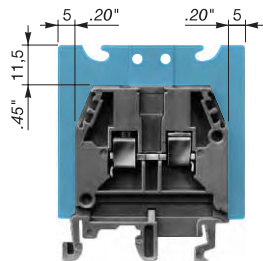

Type	Thickness		
Blocks	Color	P/N	
<b>SCF6</b>	<b>3 mm .118"</b>		
MA 2,5/5	grey	0118 707.03	
MA 2,5/5 VO	beige	0198 707.04	
M 4/6 except D and G	blue	0128 707.05	
M 4/6.H			
M 6/8			
MA 10/10			
<b>SCF6 V0</b>	<b>3 mm .118"</b>		
MA 2,5/5 V0	beige	0198 707.04	
M 4/6 V0 except D and G			
M 4/6.H			
M 6/8 V0			
M 10/10 V0			
<b>SCF6G</b>	<b>3 mm .118"</b>		
M 4/6.G	grey	0113 075.17	
	blue	0123 075.11	
<b>SCF6G V0</b>	<b>3 mm .118"</b>		
M 4/6.G V0	beige	0193 075.10	
<b>SCF12</b>	<b>3 mm .118"</b>		
M 16/12	grey	0113 102.10	
<b>SCF12 V0</b>	<b>3 mm .118"</b>		
M 16/12 V0	beige	0193 102.11	
<b>SCF16</b>	<b>3 mm .118"</b>		
M 35/16	grey	0113 101.17	
<b>SCF16 V0</b>	<b>3 mm .118"</b>		
M 35/16 V0	beige	0193 101.10	
<b>SCF22</b>	<b>3 mm .118"</b>		
M 70/22	grey	0113 851.16	
<b>SCF22 V0</b>	<b>3 mm .118"</b>		
M 70/22 V0	beige	0193 851.17	
<b>SCFT2</b>	<b>3 mm .118"</b>		
M 6/8.ST	grey	0114 522.05	
<b>SCFT2 V0</b>	<b>3 mm .118"</b>		
M 6/8.ST V0	beige	0194 522.06	

For blocks : **M 4/6** except **D** and **G**  
**M 6/8 - M 10/10**  
**M 4/6.H**  
**M 1,5/6.HH** and **ADV**

Thickness : 2 mm .079"

**SCF61** grey **0114 202.25**

✓ For **M 4/6.D** block only

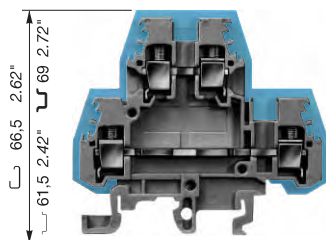

Extends 2 mm .079" around the block.  
 Thickness : 1 mm .039"  
 For **M 4/6.D** block

**SCF6.D** grey **0118 495.17**

For **M 4/6.D V0** block

**SCF6.D V0** beige **0198 495.10**

✓ Only for **NTLP** blocks with cut-out for busbar passage. Snapped on **PR3**, **PR4** and **PR5** rails.

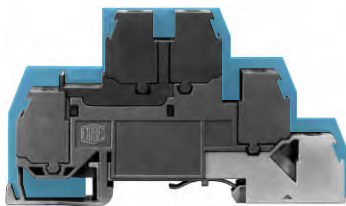

Extends 3 mm .12" around the block except the top.  
 Thickness : 1,5 mm .059"

**SCF.D** grey **0114 117.07**

### Snap-on end sections for rails / separators

#### SCFM6

✓ Allows mounting of a protective cover CPM, and a marker-holder PEP. Mounting on **PR1**, **PR3**, **PR4** and **PR5** rails

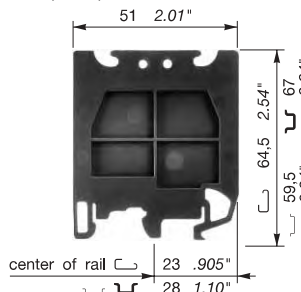

For blocks : **M 4/6**  
**M 6/8**  
**M 10/10**

Thickness : 3 mm .118"

**SCFM6** grey **0114 825.05**

#### SCF9

✓ Allows mounting of a protective cover CPM, and a marker-holder PEP. Mounting on **PR1**, **PR3**, **PR4** and **PR5** rails

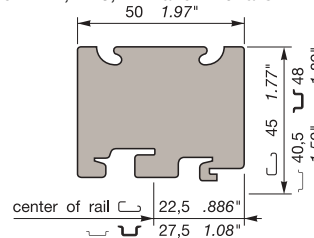

For blocks : **M 6/9.EE**  
**M 6/12.FF**

Thickness : 1 mm .039"

**SCF9\*** white **0103 672.01**

\* This separator does not replace an end section which must be used on the block.

#### SCFT1

✓ Separator for use with 1/4 turn terminal blocks, which allows mounting of one or two protective covers CPM side by side.

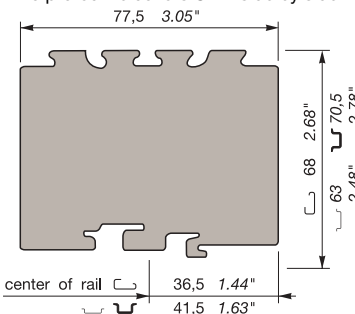

Thickness : 1 mm .039"

**SCFT1** grey **0103 588.26**

Same snap-on feature as separator SCF9  
 Thickness of the separator : 77,5 mm 3.05"

#### SCFEX

Separator for use with explosive atmosphere terminal blocks.

It can also be used for blocks spacing 5 to 16 mm.

✓ Mounting on **PR3** and **PR5** rails

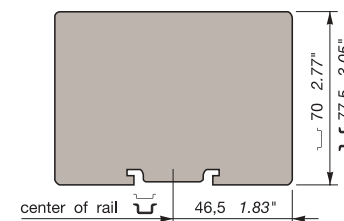

Thickness : 2,4 mm .094"

**SCFEX3\*** grey **0103 620.01**

✓ Mounting on **PR1** rail only.

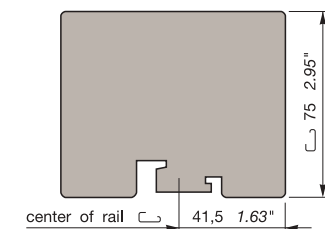

Thickness : 2,4 mm .094"

**SCFEX1\*** grey **0103 619.04**

\* When the block used has snap-on feature, use circuit separator SCF.

## SC Separator end section

(cont.)

### SCFCV

Allows mounting of a protective cover CPM and a marker-holder PEP.

Thickness: 3 mm .12"

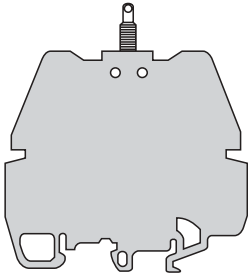

#### For blocks:

MA 2,5/5 - M 4/6 - M 6/8  
M 10/10 - M 16/12 - M 35/16

**SCFCV1-2** grey **0116 795.11**

**SCFCV1-2 V0** beige **0196 795.12**

#### For blocks:

M 6/8.STA - M 6/8.SF

**SCFCV3** grey **0116 796.12**

**SCFCV3 V0** beige **0196 796.13**

#### For blocks:

M 70/22 - MB 25/30.SF - MB 10/24.SF  
M 10/12.SF - MU 10/13  
M 10/13.TSF

**SCFCV4** grey **0116 797.13**

**SCFCV4 V0** beige **0196 797.14**

#### For blocks:

M 6/8.ST

**SCFCV5** grey **0116 798.24**

**SCFCV5 V0** beige **0196 798.25**

## CP Protective cover

### CPV

Protective cover of transparent PVC, length 1 m 3'3" (39") approx.

For cover mounting, place a separator end section SCFCV every 400 mm approx., at terminal assembly extremities.

It can also be used for marking the terminal unit by means of a blank marker strip RTC, which sticks under the cover.

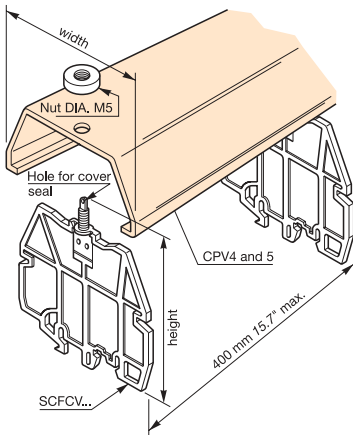

**For separator:** SCFCV1-2  
width: 73 mm 2.87"  
length:  $\sim$  66.5 mm 2.62"  
 $\sim$  74 mm 2.91"  
 $\sim$  72 mm 2.83"

**CPV1-2** **0176 816.12**

**For separator:** SCFCV3  
width: 85 mm 3.35"  
length:  $\sim$  68.5 mm 2.70"  
 $\sim$  76 mm 2.99"  
 $\sim$  74 mm 2.91"

**CPV3** **0176 817.13**

**For separator:** SCFCV4  
width: 104 mm 4.09"  
length:  $\sim$  90.5 mm 3.56"  
 $\sim$  98 mm 3.86"  
 $\sim$  96 mm 3.78"

**CPV4** **0176 791.21**

**For separators:** SCFCV5  
width: 104 mm 4.09"  
length:  $\sim$  72 mm 2.83"  
 $\sim$  79.5 mm 3.13"  
 $\sim$  77.5 mm 3.05"

**CPV5** **0176 791.21**

### CPMS

20 poles divisible cover for 12 poles use.

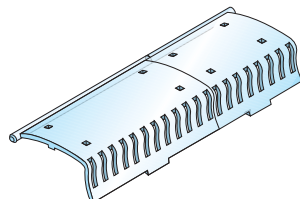

**CPMS** **0205 227.01**

### CPM

Protects the user from accidentally touching live circuits.

This cover is clipped onto the end sections (FE), onto the intermediate sections (FJ), and onto the SCF or SCFM separators. It can also be used for marking the terminal unit by means of a blank strip RTC, which slides into the cover.

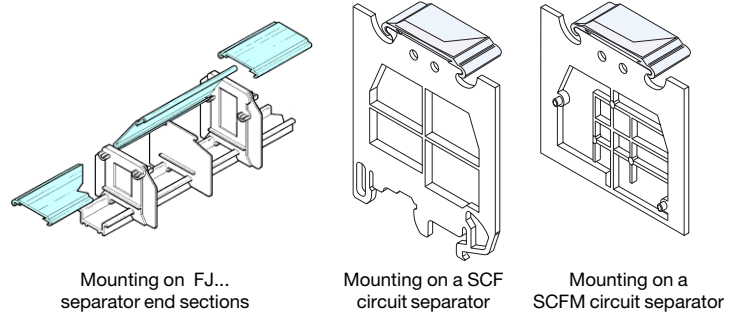

Width 32 mm/1.26", in length of 500 mm/19.70".

<b>CPM</b>	clear	<b>0187 312.14</b>
<b>CPM</b>	beige	<b>0197 312.16</b>
<b>CPM</b>	yellow	<b>0199 405.27</b>

### CPP

This type of cover fits only on ECP partitions (for Type I power terminal blocks). It snaps onto the partition and increases the space by 1,5 mm .059".

For each spacing, there are 3 cover sizes, for 1, 2 or 3 blocks.

Thickness of the cover: 1,5 mm.

Spacing			
- 26 mm	1 block	<b>CPP261</b>	<b>0168 202.13</b>
	2 blocks	<b>CPP262</b>	<b>0168 201.12</b>
	3 blocks	<b>CPP263</b>	<b>0163 403.20</b>
- 31 mm	1 block	<b>CPP311</b>	<b>0168 204.15</b>
	2 blocks	<b>CPP312</b>	<b>0168 203.14</b>
	3 blocks	<b>CPP313</b>	<b>0163 409.06</b>
- 35 mm	1 block	<b>CPP351</b>	<b>0168 206.17</b>
	2 blocks	<b>CPP352</b>	<b>0168 205.16</b>
	3 blocks	<b>CPP353</b>	<b>0163 418.26</b>
- 42 mm	1 block	<b>CPP421</b>	<b>0168 208.21</b>
	2 blocks	<b>CPP422</b>	<b>0168 207.10</b>
	3 blocks	<b>CPP423</b>	<b>0163 424.14</b>

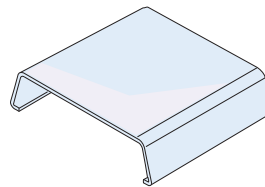

### CPTR Protecting covers for strip terminal blocks

**Characteristics** - body: Clear PVC  
- thickness: 1.5 mm

#### How to order

1	Mark the type of cover <b>CPTR</b> (table1)
2	Mark the number of contacts on the terminal block

Protecting covers	A
<b>CPTR 38 + CPTR 80</b>	<b>15</b>
<b>CPTR 716</b>	<b>18</b>
<b>CPTR 916</b>	<b>23</b>
<b>CPTR 950</b>	<b>23</b>
<b>CPTR 110</b>	<b>29</b>
<b>CPTR 143</b>	<b>34</b>
<b>CPTR 175</b>	<b>47</b>
<b>CPTR 220</b>	<b>51</b>

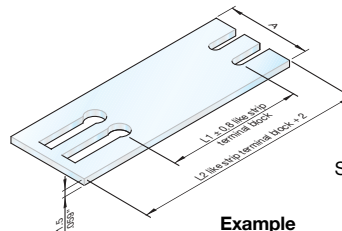

Screw and cross pieces are supplied.

#### Example

**CPTR 716 - 6**  
Protecting cover for US 716 with 6 poles.