

# S E N T R O L

P R O D U C T I N F O R M A T I O N B U L L E T I N



## 2300 SERIES PANEL DOOR MAGNETIC CONTACT

Model numbers: 2315, 2317, 2325, 2327



- **Designed specifically for panel or sectional style overhead doors**
- **Integrated mounting bracket**
- **Adjusts to fit most doors**
- **Fast installation with minimal effort**
- **Wide operating gap distance**
- **Fewer service calls**
- **All necessary mounting hardware included**

The Sentrol 2300 Series Panel Door magnetic contacts are designed specifically for panel or sectional style overhead doors. The unique design allows the contact to be mounted directly to the door channel, with the magnet mounted vertically on the door – off the floor and out of harm's way. This eliminates service calls and false alarms that occur when typical floor-mount contacts become damaged or as the door becomes misaligned with normal usage. The contact's integrated mounting bracket is adjustable to fit most door channel widths. Installation requires no special tools and takes only a few minutes. The 2300 Series contacts are constructed with a rugged extruded aluminum housing potted with Sentrol's exclusive polyurethane potting compound which makes the unit corrosion resistant.

# Sentrol 2315 Series Panel Door Magnetic Contacts

Contact and magnet shall be in extruded aluminum type housing. Contact shall be sealed in Sentrol's exclusive polyurethane potting compound. Mounting brackets shall be furnished with contact.

## Specifications:

### Form A (2315, 2325)

Voltage..... 100 V AC/DC max.  
 Current ..... 0.5 A max.  
 Power..... 7.5 W max.

### Form C (2317, 2327)

Voltage..... 30 V AC/DC max.  
 Current ..... 0.25 A max.  
 Power..... 3.0 W max.

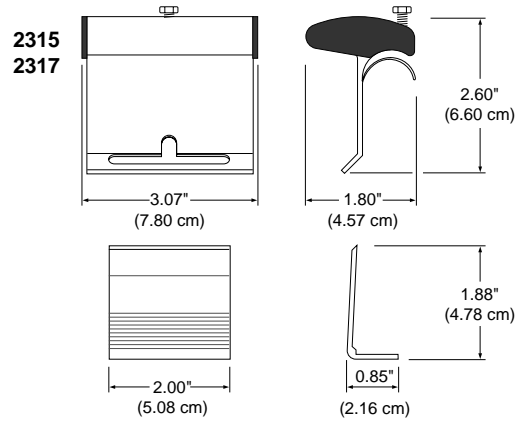

## 2315 / 2325

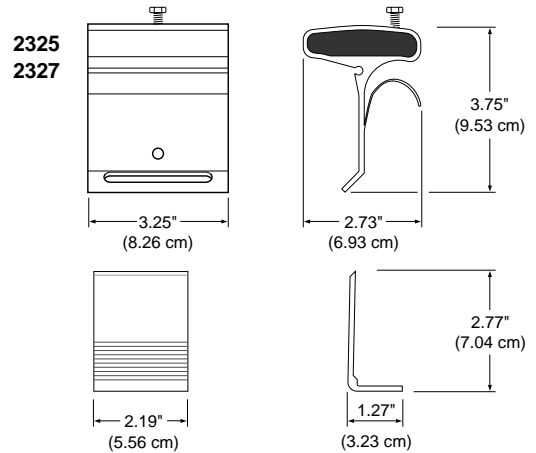
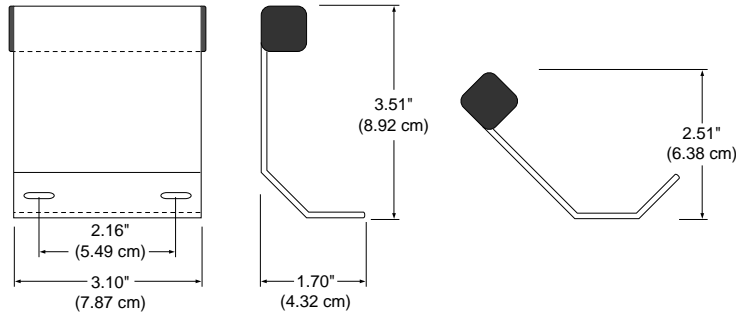
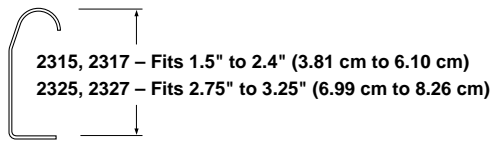

## ORDERING INFORMATION

Model Number	Loop Type	Electrical Configuration	Gap Distance (Make)*	Lead Type	Listing
2315	Closed	N.O.	Up to 3"	2' vinyl jacketed	UL
2315A	Closed	N.O.	Up to 3"	2' stainless steel armored cable	UL
2317	Open or Closed	S.P.D.T.	Up to 3"	2' vinyl jacketed	UL
2317A	Open or Closed	S.P.D.T.	Up to 3"	2' stainless steel armored cable	UL
2317AH	Open or Closed	S.P.D.T.	3/4" min, 2 1/2 max	2' stainless steel armored cable	UL
2317H	Open or Closed	S.P.D.T.	3/4" min, 2 1/2 max	2' vinyl jacketed	UL
2325	Closed	N.O.	Up to 3"	2' vinyl jacketed	UL
2325A	Closed	N.O.	Up to 3"	2' stainless steel armored cable	UL
2327	Open or Closed	S.P.D.T.	Up to 3"	2' vinyl jacketed	UL
2327A	Open or Closed	S.P.D.T.	Up to 3"	2' stainless steel armored cable	UL

Note: \*Gap distances are nominal make distance  $\pm 20\%$ . Gap specifications are for switch to make.

Break distance is approximately 1.1 to 1.5 times make.

Protected by U.S. Patent 6,011,469.

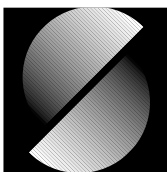

**SENTROL**