

# Pushbutton Enclosures - NEMA 12, 13

## 1490/ 1490M Sloped Front Console Series

Operator Interface Enclosure



### Application

- Designed to accept standard heavy duty oil tight pushbuttons, switches and pilot lights.
- Ideal for wall or surface mounting to provide the necessary control slope.
- Provides protection from dirt, dust, oil and water.

### Standards

- UL 508 Type 12 and 13
- CSA Type 12 and 13
- JIC standard EGP-1-1967
- **Complies with**
  - NEMA Type 12 and 13
  - IEC 60529, IP54
- Appropriate components are required to maintain these standards.

### Construction

- Formed 14 gauge steel.
- Smooth continuously welded seams.
- Construction provides either a 30° or 60° slope on front cover depending on mounting position.
- Welded brackets provide for enclosure mounting.
- Captive cover screws thread into sealed wells.
- Larger enclosures provide internally hinged removable covers designed to hold the cover open during wiring (as noted in table).
- Oil resistant gasket and adhesive.
- A grounding stud is provided in the enclosure.

### Finish

- Cover and enclosure are phosphatized and finished in ANSI 61 gray powder coating.

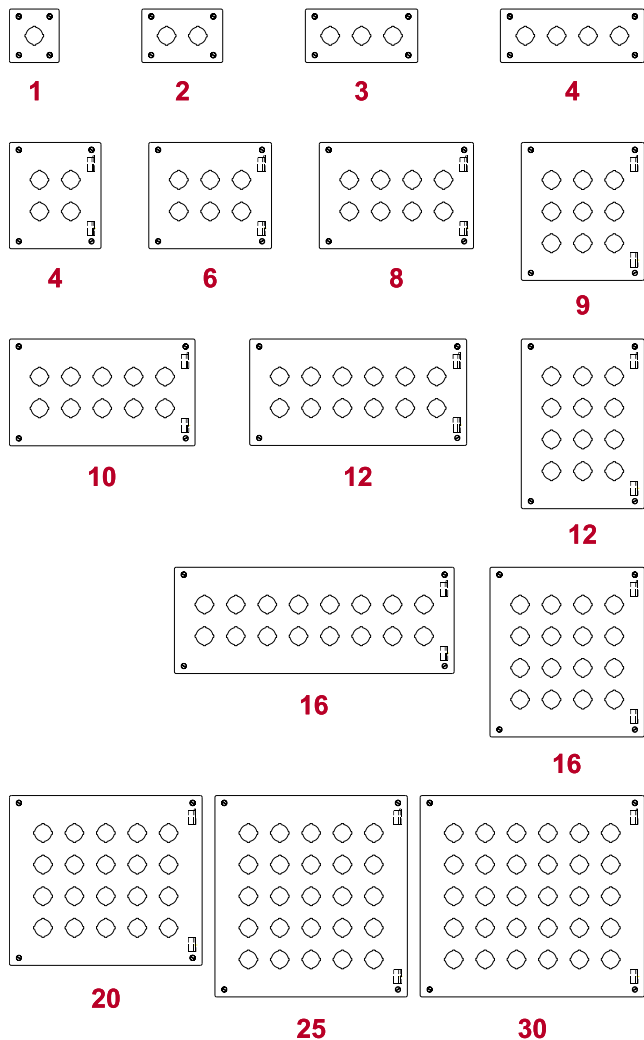

### Accessories

- Hole plugs...see page **432**
- Pedestals...see page **449**

Pushbutton Enclosures

# Pushbutton Enclosures - NEMA 12, 13

## 1490/1490M Sloped Front Console Series

Operator Interface Enclosure

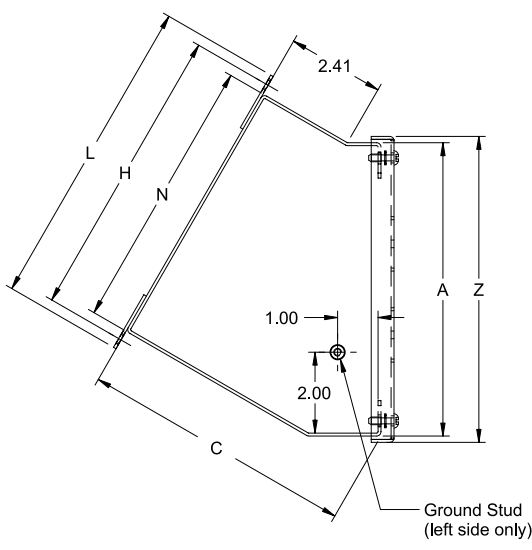

**Side View**  
1490G4-K30  
1490MG4-MK30

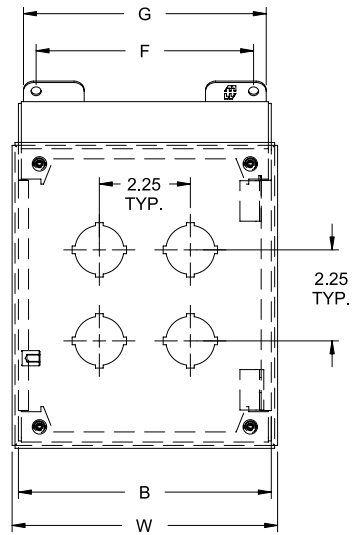

**Front View**

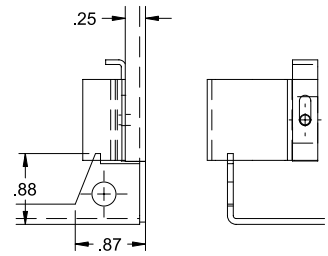

**Hinge Detail**  
Retractable pin allows door to be mount on left side or right side.

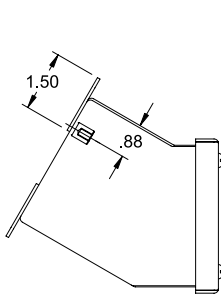

**Side View**  
1490D1-D4  
1490MD1-MD4

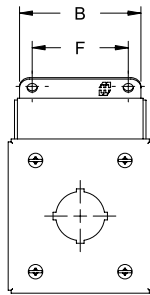

**Front View**

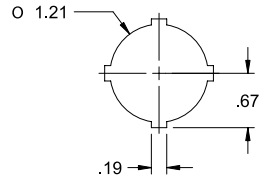

30.5mm Detail (1490 Series)

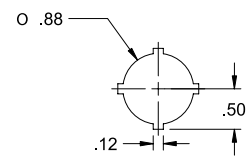

22.5mm Detail (1490M Series)

Pushbutton Enclosures

Part No.		No. Of Holes	Dimensions											Ship Wt. lbs.
30.5mm Holes	22.5mm Holes		A	B	C	F	G	H	L	N	W	Z		
1490D1 <sup>1</sup>	1490MD1 <sup>1</sup>	1	3.50	3.25	4.88	2.38	3.00	4.03	4.53	3.53	3.56	3.81	2	
1490D2 <sup>1</sup>	1490MD2 <sup>1</sup>	2	3.50	5.50	4.88	4.63	5.25	1.03	4.53	3.53	5.81	3.81	3	
1490D3 <sup>1</sup>	1490MD3 <sup>1</sup>	3	3.50	7.75	4.88	6.88	7.50	4.03	4.53	3.53	8.06	3.81	5	
1490D4 <sup>1</sup>	1490MD4 <sup>1</sup>	4	3.50	10.00	4.88	9.13	8.75	4.03	4.53	3.53	10.31	3.81	6	
1490G4	1490MG4	4	7.25	6.25	6.75	5.38	6.00	7.28	7.78	6.78	6.56	7.56	6	
1490G6	1490MG6	6	7.25	8.50	6.75	7.63	8.25	7.28	7.78	6.78	8.81	7.56	7	
1490G8	1490MG8	8	7.25	10.75	6.75	9.88	10.50	7.28	7.78	6.78	11.06	7.56	9	
1490H9	1490MH9	9	9.50	8.50	7.88	7.63	8.25	9.25	9.75	8.75	8.81	9.81	9	
1490G10	1490MG10	10	7.25	13.00	6.75	12.13	12.75	7.28	7.78	6.78	13.31	7.56	10	
1490G12	1490MG12	12	7.25	15.25	6.75	14.38	15.00	7.28	7.78	6.78	15.56	7.56	11	
1490J12	1490MJ12	12	11.75	8.50	9.00	7.63	8.25	11.19	11.69	10.69	8.81	12.06	13	
1490G16	1490MG16	16	7.25	19.75	6.75	18.88	19.50	7.28	7.78	6.78	20.06	7.56	14	
1490J16	1490MJ16	16	11.75	10.75	9.00	9.88	10.50	11.19	11.69	10.69	11.06	12.06	14	
1490J20	1490MJ20	20	11.75	13.00	9.00	12.13	12.75	11.19	11.69	10.69	13.31	12.06	16	
1490K25	1490MK25	25	14.00	13.00	10.13	12.13	12.75	13.13	13.63	12.63	13.31	14.31	17	
1490K30	1490MK30	30	14.00	15.25	10.13	14.38	15.00	13.13	13.63	12.63	15.56	14.31	19	

<sup>1</sup> Not hinged