

CS Series – Heavy Duty Cam Switches

Key features of the CS Series include:

- Wide variety of heavy-duty oiltight cam switches
- Operators available up to 12 positions
- Switches made with a double circuit contact block
- Contact blocks rated 600V, 10A
- Ideal for ammeter/voltmeter applications
- Built to order — not available in subcomponents
- UL listed and CSA certified
- NEMA Type 4, 13



UL Listed
File No. E68961



CSA Certified
File No. LR48366

Contact Ratings

Rated Thermal Current		10A			
AC	Break Current	120V/5A	240V/3A	480V/2A	600V/1A
DC	Resistive	Break Current	24V/8A	110V/8A	220V/1A
		Break Current	24V/5A	110V/1.2A	220V/0.45A
	Inductive	Make Current (A)	Rated amperage x 1.1		
Electrical Life		500,000 operations minimum (at full rated load)			
Mechanical Life		5,000,000 (at no load)			

CS Series

Series	Appearance	Operator		Maximum Contacts To Be Mounted	Handle Styles
		Cam Angle	Position		
ACSNO		30°	Up to 12	1 to 10 decks; Up to 20 contacts	YB, SB, PB, FB
		45°	Up to 8		
		60°	Up to 6		
		90°	Up to 4		
ACSNK		30°	Up to 12	1 to 10 decks; Up to 20 contacts	HB or standard key
		45°	Up to 8		
		60°	Up to 6		
		90°	Up to 4		
UCSQO		30°	Up to 12	1 to 10 decks; Up to 20 contacts	YB, SB, PB, FB
		45°	Up to 8		
		60°	Up to 6		
		90°	Up to 4		
UCSQM		45° Spring return	Only 3	1 to 3 decks; Up to 6 contacts	YB, SB, PB, FB



1. Do not use spring return (SR) for more than six contacts.
2. Two identical keys come with ACSNK unit. Specify "H" for handle key option.
3. For handle styles, see page 645.

Illuminated Selector Switches (Assembled)

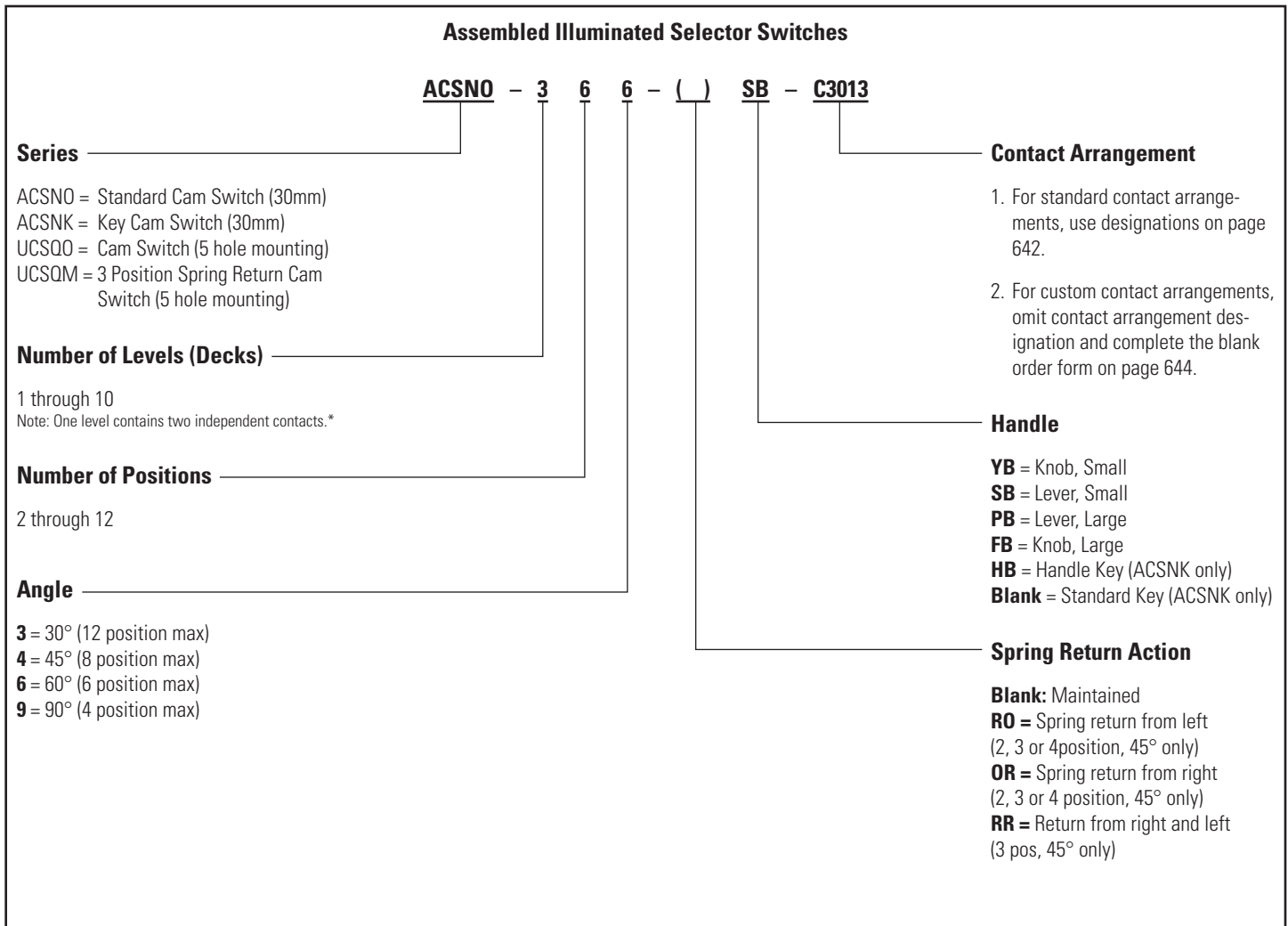

- *Contact blocks may contain two independent contacts, (a four position switch with four independent contacts only requires two contact blocks).
- *Caution: switches with 180° or more of rotation may require separate blocks for each contact due to cam overlapping.
- Key retainable in every 45° position (45, 90, 180, 225, 270, 315, 360).

Contact Arrangements

Standard Arrangements

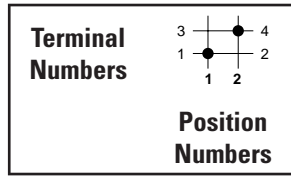

C-1001



C-1002



C-1014



C-1005

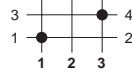

C-1008

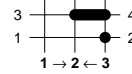

C-2001

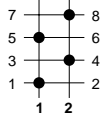

C-2002

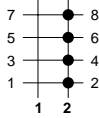

C-2006

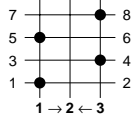

C-2004

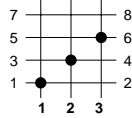

C-2008

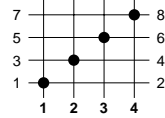

C-2009

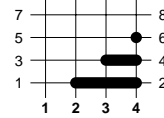

C-2027

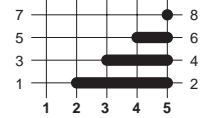

C-3001

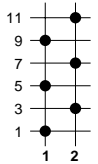

C-3002

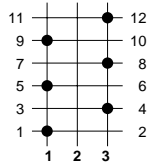

C-3005

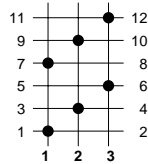

C-3013

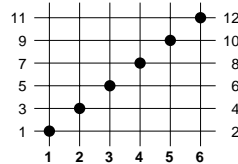

C-3016

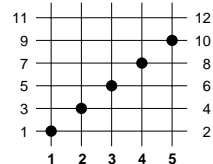

C-4001

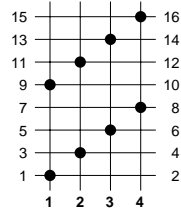

C-4002

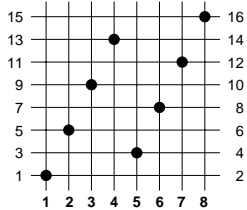

C-5001

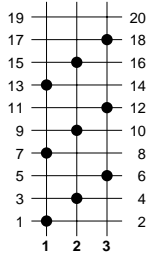

C-6001

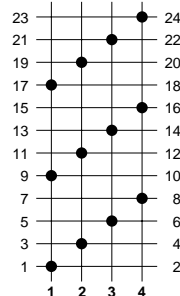

C-6002

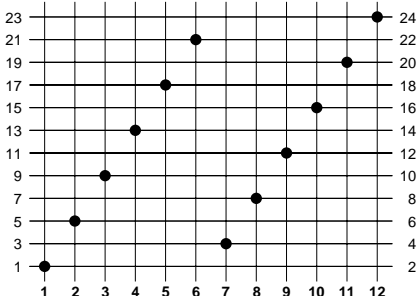

Switches & Pilot Lights
Display Lights
Relays & Sockets
Timers
Terminal Blocks
Circuit Breakers

Contact Arrangements continued

Ammeter Switching

C-1012

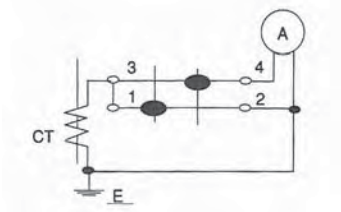

C-4007

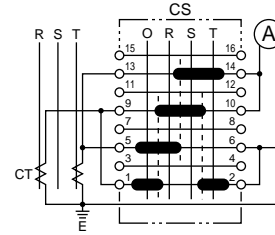

C-4003

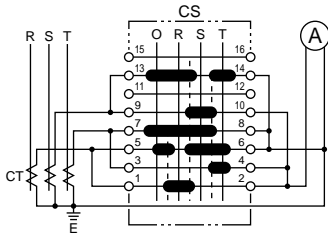

C-6003

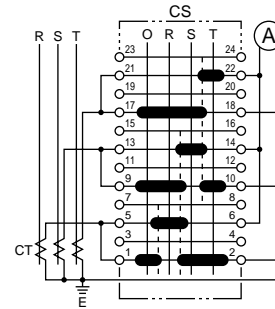

Voltmeter Switching

C-2022

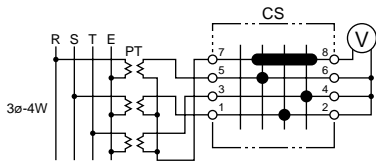

C-3008

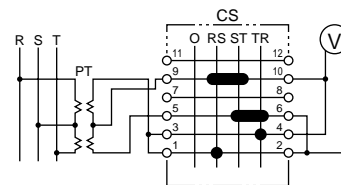

C-3009

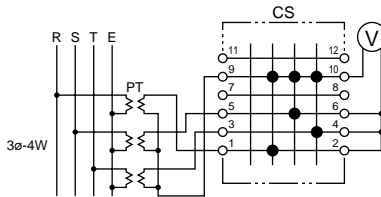

C-3007

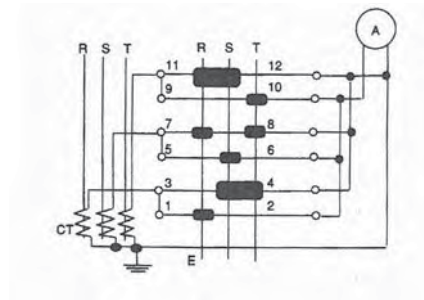

Order Form (Custom Contact Arrangement)

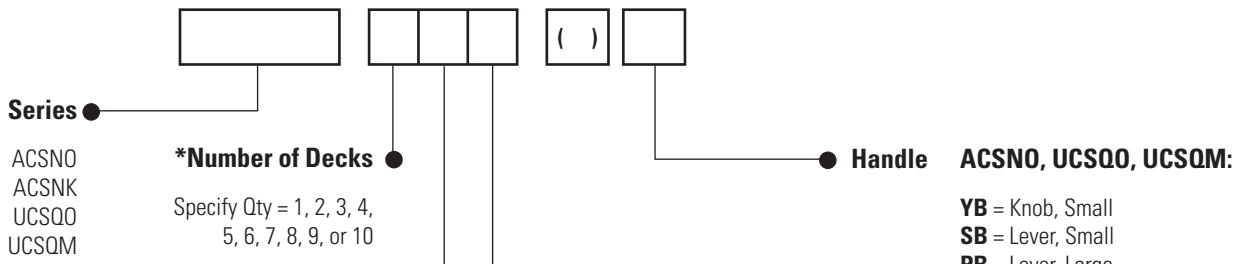

*Note: One Deck can drive two independent contacts.

Number of Positions

Unit	Angle	Positions
ACSNO ACSNK* UCSQO	30° only	9, 10, 11, 12
	30° or 45° only	7 or 8
	30°, 45° or 60°	5 or 6
UCSQM	30°, 45°, 60°, 90°	2, 3, or 4
	45° only	3 only

Spring Return

Blank = Maintained
RO = Spring return from left
(3 or 4 position, 45°)
OR = Spring return from right
(3 or 4 position, 45°)
RR = Return from right and left
(3 position, 45°)

ACSNK:
HB = Handle Key (option)
Blank = Standard Key

For handle styles, see page 645.

Angle
3 = 30°
4 = 45°
6 = 60°
9 = 90°

UCSQM is available in spring-return version only.

* ACSNK keys only remove at 45°.

Contact Arrangement Table

Cams	Terminal Numbers	Position											
		1	2	3	4	5	6	7	8	9	10	11	12
Deck 1	1 and 2												
	3 and 4												
Deck 2	5 and 6												
	7 and 8												
Deck 3	9 and 10												
	11 and 12												
Deck 4	13 and 14												
	15 and 16												
Deck 5	17 and 18												
	19 and 20												
Deck 6	21 and 22												
	23 and 24												
Deck 7	25 and 26												
	27 and 28												
Deck 8	29 and 30												
	31 and 32												
Deck 9	33 and 34												
	35 and 36												
Deck 10	37 and 38												
	39 and 40												

To specify non-standard arrangements (designation not on preceding pages), fill in this table using the following symbols.
X = Closed contact (break before make) **O** = Open contact **X-X** = Overlapping contact (remain on when switch is moved between two positions)

Specifying Nameplate (Optional)

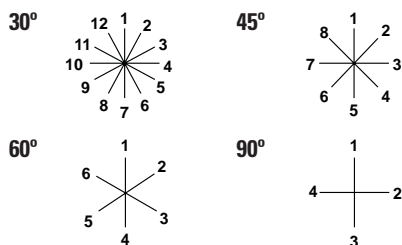

Specifying Legends

Position

1 _____
 2 _____
 3 _____
 4 _____
 5 _____
 6 _____

If no engraving information is provided, a blank nameplate will be supplied.

1 _____
 2 _____
 3 _____
 4 _____
 5 _____
 6 _____

Accessories — CS Series

Replacement Handles

Part Number	CSH-YB	CSH-SB	CSH-PB	CSH-FB	CSH-H2B
Dimensions	0.79"D x 1.61"H	0.79"D x 1.97"H	1.58"D x 1.97"H	1.58"D x Ø 1.97"	0.95"D x 2.28"H
Applicable Models	ACSNO, UCSQO, UCSQM				ACSNK

Replacement Nameplates

Size & Shape □ 2.52" (64mm) Black Aluminum			
Part Number	CQ	CQM	CQN
Applicable Models	UCSQO	UCSQM	ACSNO, ACSNK

- 1. Extra cost for engraving, 3/16" min. letter height, Legends maximum ten characters.
- 2. Blank nameplates are supplied with all cam switches (they need not be ordered separately).

Wiring Clips

Part Number	Contact Block Jumpers
CJ-1 	Between decks
CJ-2 	Same deck

Replacement Keys

Part Number	
K301 	Pair of keys (#301)

Switches & Pilot Lights

Display Lights

Relays & Sockets

Timers

Terminal Blocks

Circuit Breakers

Dimensions/Terminal Arrangements/Mounting Holes

ACSNO

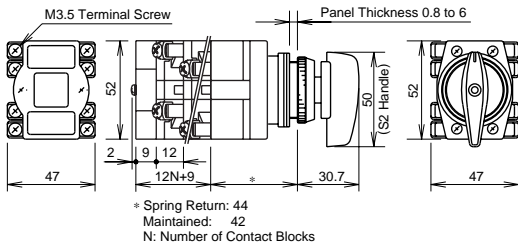

ACSNK

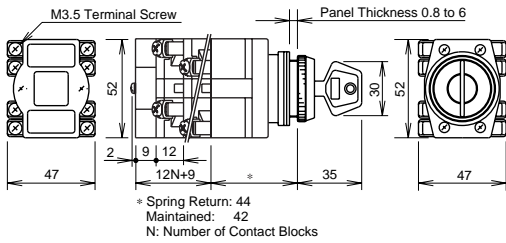

UCSQ0

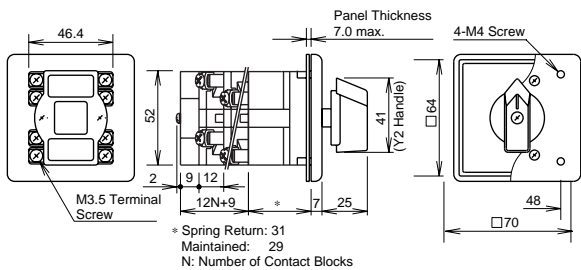

UCSQM

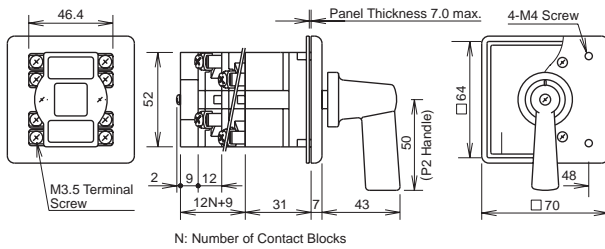

Terminal Arrangement

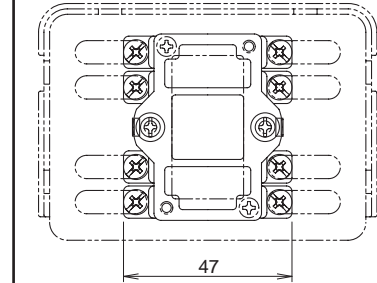

Mounting Holes

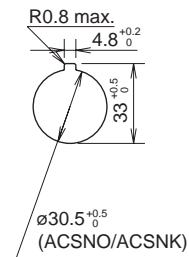

**UCSQ0
UCSQM**

