

NRBM Series

NRBM circuit breakers are the largest in rated current (1A to 50A) among the IDEC circuit breakers series. These small sized, high-efficiency breakers offer a variety of protection characteristics that can be widely employed for semiconductors, relay circuits, heater circuits, transformers, and solenoids.

Key features of the NRBM series include:

- Excellent overload and short circuit protection
- Small size and high efficiency
- Life expectancy of over 10,000 operations
- UL1077 recognized Supplementary Protectors
- VDE Certified to EN60934



File No. E68029



License #113434

General Specifications

Protection Method	Electromagnetic tripping
Internal Circuit	Series current trip
Number of Poles	1, 2, 3
Rated Voltage	250V AC, 50/60Hz, 65V DC
Rated Tripping Currents	Current trip: 1A, 2A, 3A, 5A, 7.5A, 10A, 15A, 20A, 25A, 30A, 40A, 50A
Rated Interrupting Capacity	250V AC, 50/60Hz, 1,000A 65V DC, 1,000A
Auxiliary Contacts / Alarm Contact	SPDT microswitch 250V AC, 5A (resistive load) 50V DC, 1 A (resistive load)
Reference Temperature	25°C
Ambient Operating Temperature	-40 to +85°C (avoid freezing)
Insulation Resistance	100MΩ (measured with 500V megger)
Dielectric Strength	Between main circuit terminals: 2,000V AC, 1 minute Between main circuit and auxiliary contact: 2,000V AC, 1 minute
Vibration Resistance	100N (approximately 10G), 10 to 55Hz
Shock Resistance	1,000N (approximately 100G)
Life Expectancy	10,000 operations minimum (at 6 operations per minute)
Terminal Style	Main terminal: M5 stud Auxiliary contact/ alarm contact: Quick-connect tab 0.110" terminal
Weight	1-pole/100g 2-pole/200g 3-pole/300g



Not suitable for branch circuit protection.

Part Numbering Guide

NRBM series part numbers are composed of 6 part number codes. When ordering an NRBM series part, select one code from each category.
 Example: NRBM 1 1 11 F-30A-AA

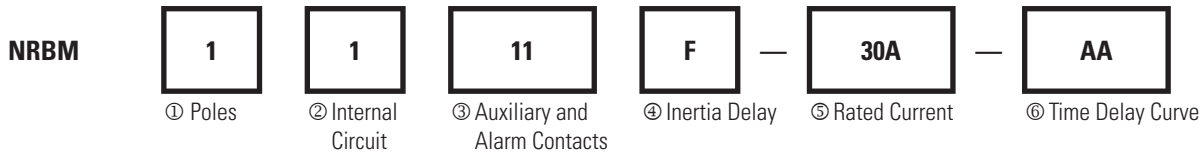

Part Number Codes: NRA Series

	Description	Part Number Code	Remarks
① No. of Poles	1-pole	1	All multiple pole circuit breakers are simultaneous throw/simultaneous break. All levers are mechanically interlocked.
	2-pole	2	
	3-pole	3	
② Internal Circuit	Series current trip	1	
③ Auxiliary and Alarm Contacts	Without	00	
	With auxiliary contact	11	Auxiliary contacts change state with lever and/or overload condition
	With alarm contact	21	Alarm contacts change state only with overload condition
④ Inertia Delay	Without inertia delay	Blank	
	With inertia delay	F	
⑤ Rated Current	Rated current (current trip)	1A, 2A, 3A, 5A, 7.5A, 10A, 15A, 20A, 25A, 30A, 40A, 50A	
⑥ Time Delay Curve	AC curves	AA, BA, MA	See page 897 for delay curves.
	DC curves	AD, MD	

- 1. For NRBM series time delay curves, see page 897.
- 2. For NRBM series dimensions, see page 899.
- 3. Not suitable for branch circuit protection.
- 4. UL recognized, applicable standard: UL1077, "Supplementary Protectors."

Switches & Pilot Lights

Display Lights

Relays & Sockets

Timers

Terminal Blocks

Circuit Breakers

Information About Circuit Breakers

Time Delay Curve Descriptions

Time Delay Curve	NRBM Application
AD, AA	Common curves used in molded-case circuit breakers.
BA	Response to overcurrent is quite fast. Suited for protection of semiconductor circuits with very little overload tolerance. If overcurrents are expected to flow, fuses may be required according to the circuit characteristics.
MD, MA	Suited for motor loads that draw high inrush currents lasting a considerable length of time.
With Inertia Delay (F)	Designed not to trip on 20 times the rated current (peak value) for a duration of 8ms. Suited for transformer and lamp loads that draw steep inrush currents.

Inertia Delay Descriptions

Circuit breakers equipped with inertia delay do not respond to high inrush currents such as those produced by transformer, lamp, or motor loads, but perform specified interruption on rated overcurrents.

Inertia delay is available with time delay curves AD, MD, AA, BA, and MA.

Specify inertia delay by inserting an "F" in the part number as shown in Part Number Guide on previous page.

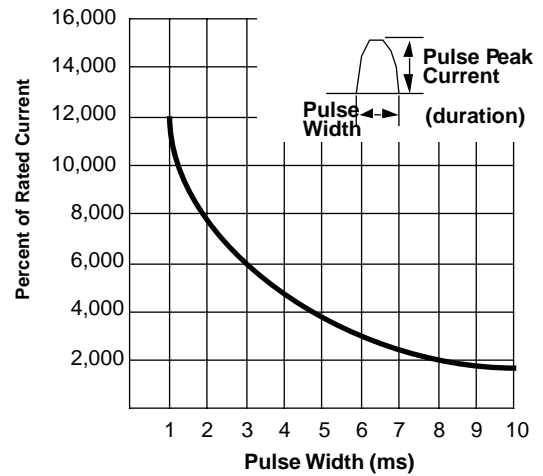

$$1. \text{Percent of Rated Current} = \frac{\text{Pulse Peak Current}}{\text{Protector Rated Current}} \times 100\%$$

2. Based on sinusoidal or parabolic pulse profile.

Notes

Multi-Pole

Multi-pole types such as 2- or 3-pole should be assembled by IDEC.

Because of their characteristics, 1-pole breakers cannot be combined to provide multi-pole units.

All multi-pole units are simultaneous break/simultaneous make, with levers mechanically interlocked.

Auxiliary and Alarm Contacts

Multi-pole units with auxiliary contacts will have one set of auxiliary contacts on the right-most breaker. Multi-pole units with alarm contacts will have one set of alarm contacts on the left-most breaker.

Internal Circuits and Terminal Arrangements

Series Current Trip

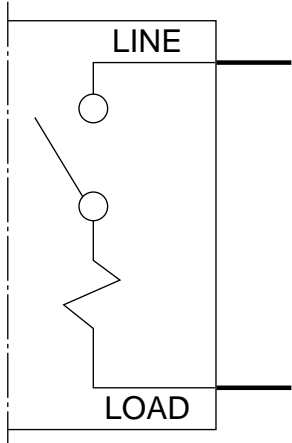

Series Current Trip with Auxiliary Contacts

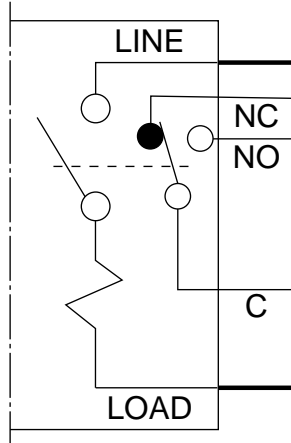

Series Current Trip with Alarm Contacts

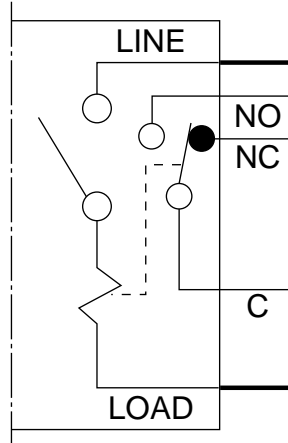

Switches & Pilot Lights

Display Lights

Relays & Sockets

Timers

Terminal Blocks

Circuit Breakers

Time Delay Curves (numerical equivalent)

Overcurrent — Time Delay Characteristics in Seconds (at 25°C)

		Percent of Rated Current								
		Curve	100%	125%	150%	200%	400%	600%	800%	1000%
AC (50/60Hz)	AA	No trip	15 – 120	8 – 45	3 – 15	0.48 – 2.5	0.06 – 0.8	0.007 – 0.13	0.005 – 0.04	
	BA	No trip	0.75 – 10	0.45 – 3.5	0.22 – 1.3	0.045 – 0.22	0.012 – 0.12	0.005 – 0.06	0.004 – 0.03	
	MA	No trip	70 – 900	30 – 260	10 – 70	1.8 – 11	0.5 – 4	0.009 – 1.1	0.006 – 0.2	
DC	AD	No trip	10 – 130	6 – 55	2.6 – 20	0.5 – 3.5	0.14 – 1.4	0.008 – 0.7	0.005 – 0.35	
	MD	No trip	35 – 400	20 – 180	8 – 60	1.6 – 10	0.6 – 4.5	0.01 – 2	0.007 – 0.5	

- 1. All values above are in seconds.
- 2. Data in this table is equivalent to information presented in the time delay curves shown on page 897.

AC Time Delay Curves

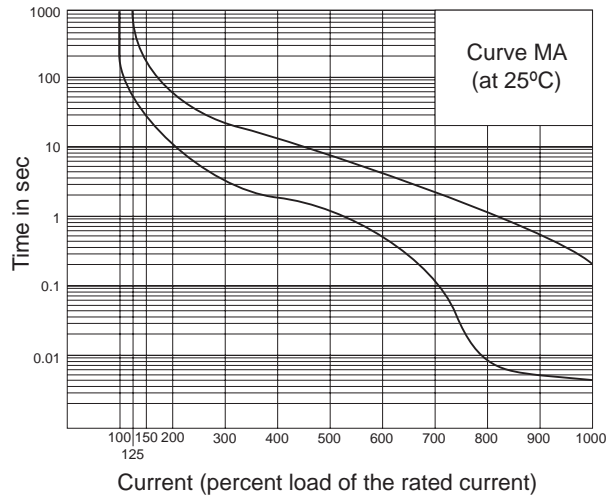
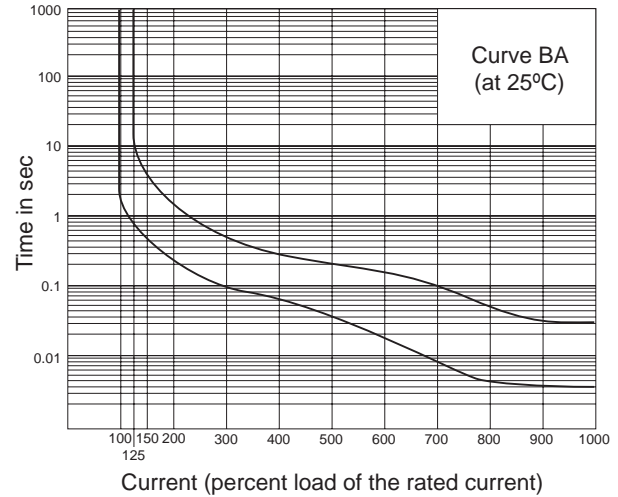
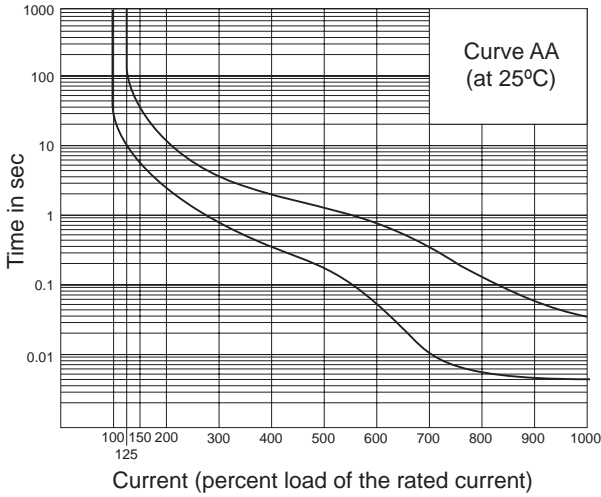

DC Time Delay Curves

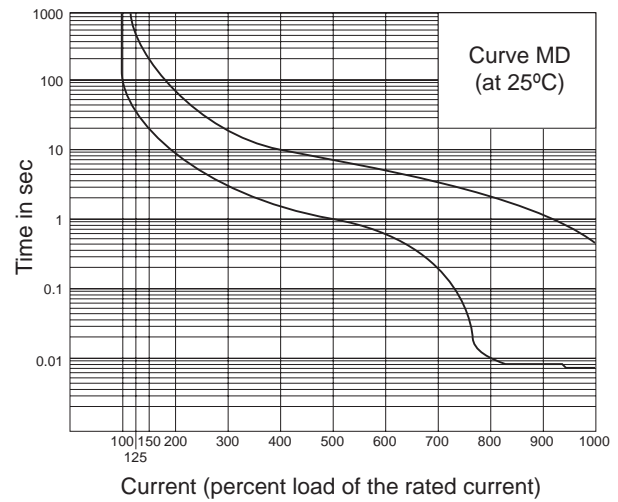
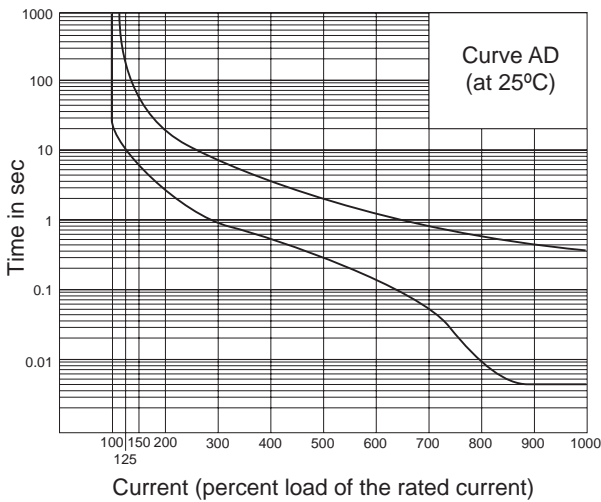

Switches & Pilot Lights

Display Lights

Relays & Sockets

Timers

Terminal Blocks

Circuit Breakers

Resistance and Impedance Characteristics

Coil Data

Rated Current	DC Resistance	AC Impedance (50/60Hz)
	Curves AD, MD	Curves AA, BA, MA
1A	1Ω	1.1Ω
2A	0.227Ω	0.245Ω
3A	0.091Ω	0.11Ω
5A	0.035Ω	0.039Ω
7.5A	0.015Ω	0.018Ω
10A	0.0088Ω	0.0124Ω
15A	0.005Ω	0.0065Ω
20A	0.003Ω	0.0047Ω
25A	0.0023Ω	0.0032Ω
30A	0.0019Ω	0.0031Ω
40A	0.0018Ω	0.002Ω
50A	0.0014Ω	0.0016Ω

Tolerance ±25% (up to 20A), ±50% (25A and over).

Coil Resistance at 25°C

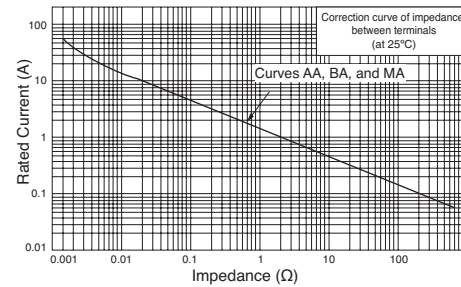
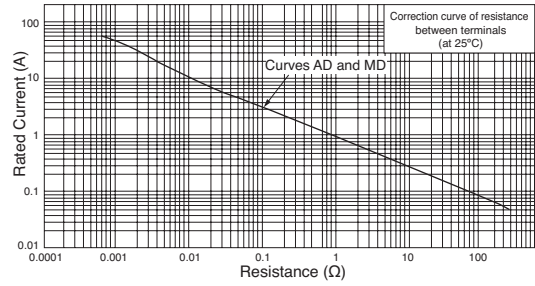

Temperature Correction Curves

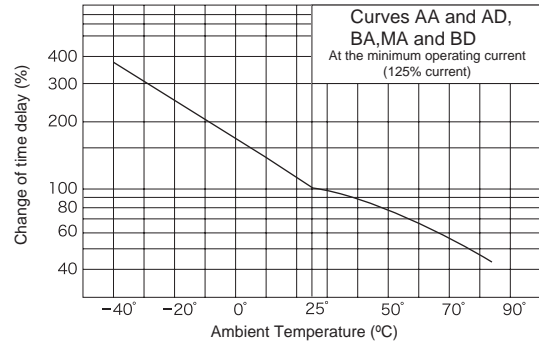

Voltage Drop Due to Resistance or Impedance

The internal resistance or impedance of a circuit breaker tends to be larger for a smaller rated current. Therefore, when circuit breakers of a small rated current are used, voltage drop should be taken into consideration. Internal resistance also varies with time delay curves, even at the same rated current. This should also be considered during installation.

Time Delay Curve and Ambient Temperature

Since NRBM series circuit breakers employ an electromagnetic tripping system, the rated current (trip current) is not affected by the ambient temperature, but the time delay varies with the oil viscosity in the tube. Lower oil viscosity at higher temperatures results in shorter delay; whereas at lower temperatures, the delay will be prolonged. The time delay curves, shown starting on page 897, are at 25°C. Time delay curves can be corrected.

Switches & Pilot Lights

Display Lights

Relays & Sockets

Timers

Terminal Blocks

Circuit Breakers

Dimensions: NRBM Series

NRBM

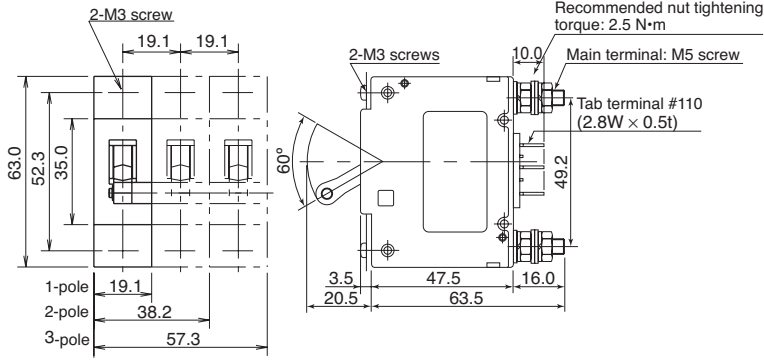

NRBM Series

Panel Cut-Outs

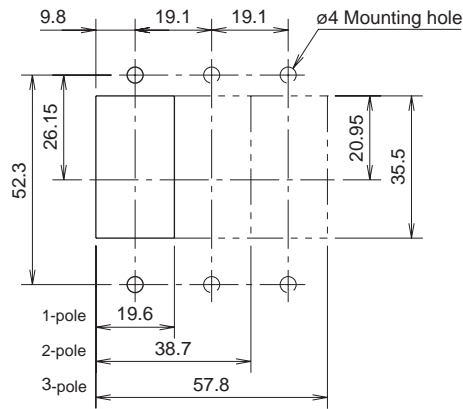

Drawings are not to scale.