

IDEC SmartRelay – The Intelligent Choice

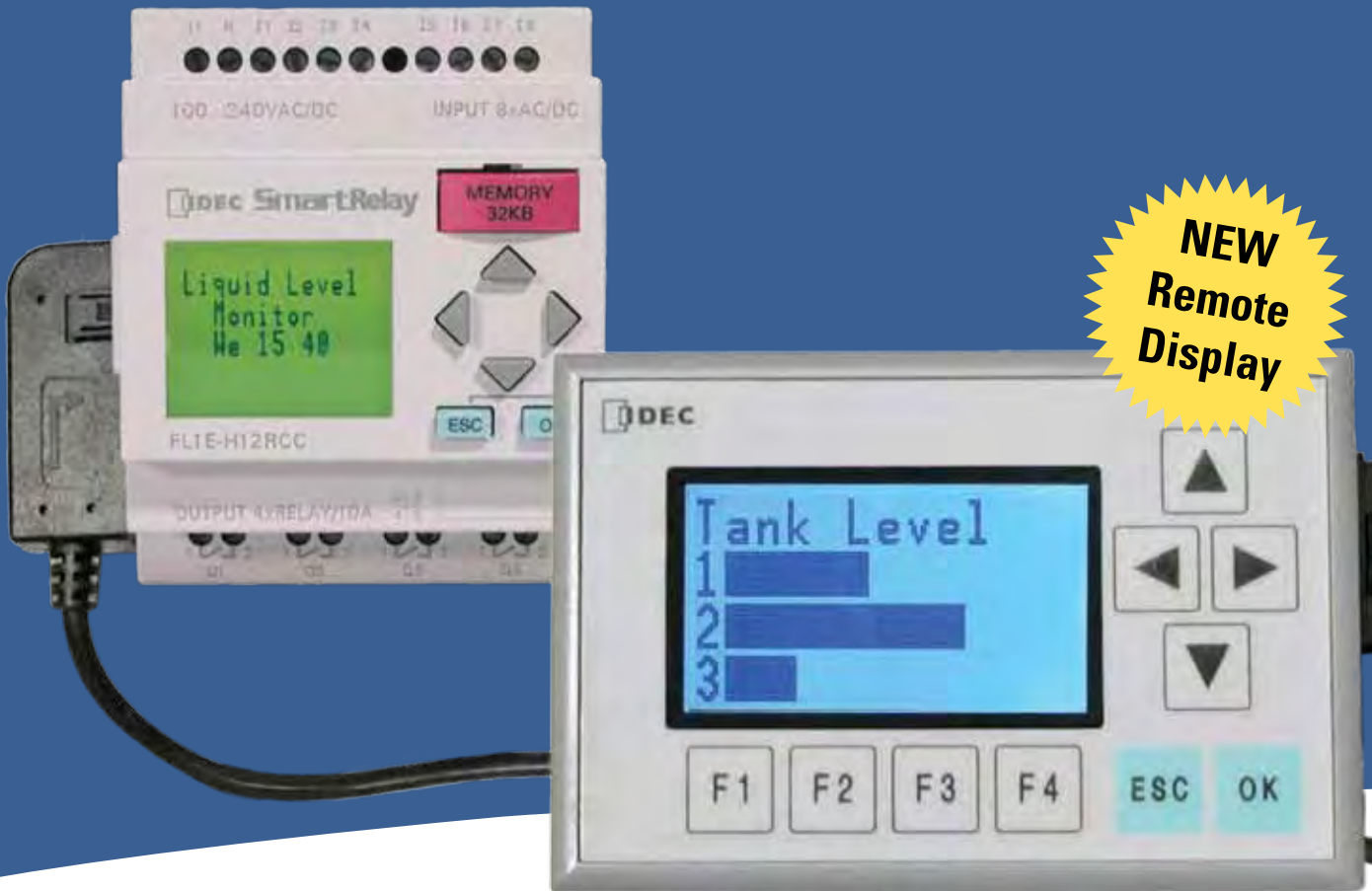

Increase your versatility with a new remote display

Look around. IDEC SmartRelays are in everything from lighting controls to ice-making machines and grocery store misters. Proving reliable time after time, these intelligent logic modules are the ideal controller for simple automation tasks. A new fifth-generation of SmartRelays offer functions to give you even more flexibility and convenience. Advances include extended memory, a brighter display with higher LCD contrast, improved analog and high-speed inputs, an external

text display, and upgraded programming software.

With an ever changing market and tough competition, you need an edge to stay on top. SmartRelay has a new HMI text display panel to do just that! This economical interface lets you make quick adjustments, while at the same time making it easy to spot and troubleshoot failures using built-in operator functions and diagnostics. So why wait? Make the smart choice, IDEC SmartRelay!



“With increased functionality and straightforward programming, IDEC SmartRelays make my job a lot easier!”

Industrial Facility Systems



- Conveyor systems
- Elevator controls
- Exhaust and filtering systems
- Automatic food dispensing machines
- Water treatment and irrigation systems
- Motor, pump and valve controls

Unique Solutions



- Solar-electric systems
- Marine systems
- Extreme environmental conditions
- Display panels and traffic light controls
- Energy management

Housing and Building Management



- Lighting controls (outside and inside)
- Door and gate controls
- Heating and cooling systems
- Shutter, sun blind and awning controls
- Water and sprinkler systems
- Ventilation systems

Monitoring Systems



- Access controls
- Alarm systems
- Limit level monitoring
- Parking Lot monitoring
- Baggage control

Control at your fingertips

New Faster Inputs

FL1E can support up to four 5KHz high-speed inputs. You have the option of configuring inputs I3, I4, I5 and I6 as fast counter inputs to give you even more flexibility.

New Built-in Analog Inputs

Each SmartRelay is equipped with 8 digital inputs that can be used for your applications. New in the FL1E 12/24VDC and 24VDC models are four built-in analog inputs. Inputs I1, I2, I7, and I8 can now be configured to accept 0-10V analog signals. Using expansion modules, you can utilize a maximum of 24 digital and 8 analog inputs.

Universal Voltages

Available in 12/24V DC for solar and vehicle applications, and 24V AC/DC for building automation, as well as 100-240V AC/DC, SmartRelay can be used for a wide variety of applications.

DIN Rail or Surface Mountable

New Controllable Backlit LCD Display

FL1E SmartRelays have a built-in LCD display with a brighter, higher contrast screen you can adjust to your own preference. System status — input, output, analog values, timers and counters — can be monitored through the 4x12 LCD screen or you can display a predefined message with up to 48 characters (chosen from 103 special character types). Non-LCD versions are also available.

New 50% More Memory

FL1E SmartRelays offer an expanded program memory of 200 function blocks! This is a 50% increase compared to the existing FL1D series.



New Memory Cartridges

Three memory cartridges are now available for FL1E: Violet, Green and Brown! Violet is a 32K high-capacity, removable program memory card. Green is a battery card that supports a Real Time Clock power supply for up to two years. Brown is a combined memory/battery card.



Operational Control Buttons

Program with just the push of a button! SmartRelay control buttons can be used to program, modify and change preset parameters. The four cursor keys can also be configured as inputs as needed.

Digital Outputs

IDEC SmartRelays are equipped with four relay outputs rated at 10A/pt. Using digital expansion modules; you can configure a maximum of sixteen outputs.

EEPROM Memory

With IDEC SmartRelays, your program is stored in a non-volatile EEPROM Memory.

New Extended Retentive Data Memory

Extended memory gives you up to 250 bytes of retentive data memory. More than 4 times that of FL1D!

New Arithmetic Functions

Analog Math function blocks allow basic arithmetic operations such as addition, subtraction, multiplication, and division.

Password Protection

Concerned about your program being copied or altered? IDEC SmartRelays keep you safe with a unique password protection scheme allowing end users to access certain parameters without seeing or modifying the actual program.

Additional text display

For the first time ever, you can connect an external text display to your SmartRelay, making it easy for you to monitor, view and troubleshoot from outside your panel. Turn to page 7 to learn more!

Quality

IDEC has built a reputation based on providing high-quality, dependable products you can trust, and our SmartRelays are no exception. Each model is cULus listed, CE certified, EMC compliant, FM approved for Class 1 Div 2 hazardous locations, C-tick compliant, Lloyds Registered and ABS approved.



Making things easier

1



Select "Program" from the main menu.

2



Create your control logic.

3



Select "Start," and you're done.

"Why worry about individual components like relays, timers, and counters, when one IDEC SmartRelay has everything you need? I reduced costs 50% and spent only a quarter of the time to do it!"

Set-up is as easy as 1, 2, 3!

Don't spend valuable time figuring out wiring! IDEC SmartRelays require minimal wiring; mount on a DIN rail with a quick snap; and make programming as simple as the touch of a button.

All IDEC SmartRelays meet industry standard approvals including cULus, CE, C-tick and ABS (American Bureau of Shipping). Plus they are FM approved for Class 1 Div 2 hazardous locations.

It's safe to say we all want to work smarter not harder, while also saving money. With IDEC SmartRelays, it's easy. These all-in-one controllers are easy-to-use and require less space in your control cabinet, which is basically money in your pocket. Combine that with low maintenance and you've got a cost-effective product you can count on for all your control operations.



Connect a new remote text display for added convenience



It doesn't get any easier than this! Now you can easily adjust settings, view status and troubleshoot failures using a remote text message display.

The IDEC SmartRelay base and text display panel are independent from each other, allowing you to choose if message will be displayed on the internal or external display, or both. With a backlit LCD (128 x 64 pixels) for easy viewing, the FL1E text display panel can show up to 50 message blocks and is capable of displaying 4x12 characters. A scrolling feature allows up to 24 character messages across the screen. Plus this intuitive visual interface supports analog values such as level sensor, flow rate, rpm, counts, temperature and more, on horizontal and vertical bar graphs. Six predefined cursor keys make screen navigation and data entry, along with four user defined function buttons configurable to your desired equipment operation.

The FL1E text display panel is IP65 and NEMA 4/4X rated for indoor wash down environments, as well as being certified with industry standard agency approval: cULus and FM Class 1 Div 2.

Adjustable Backlit LCD Display

System status — input, output, analog values, timers and counters — can be monitored through the 4x12 display.

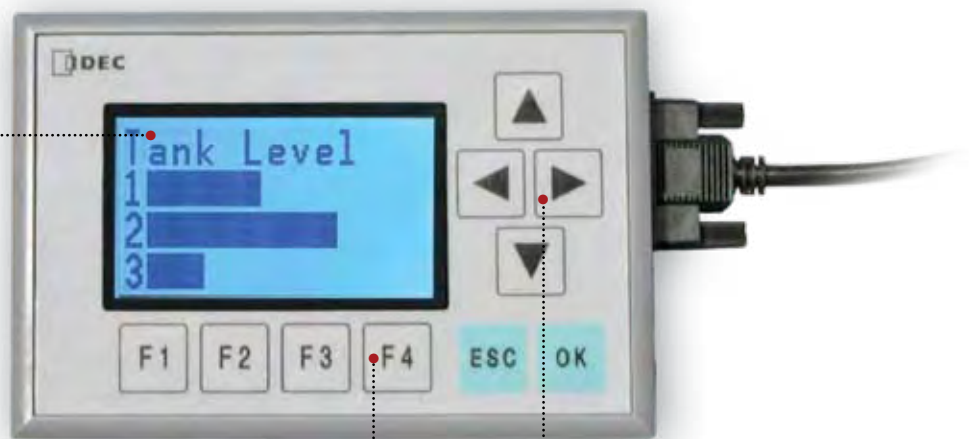

Programmable Function Keys

Four membrane switches that can be used as push-buttons, for turning on the back-light, or for starting and stopping programs.

Operational Control Buttons

Modify and change preset parameters or scroll the screen with just the push of a button! Each button has the same functions as the base unit and can also be configured as inputs as needed.



Expand your possibilities

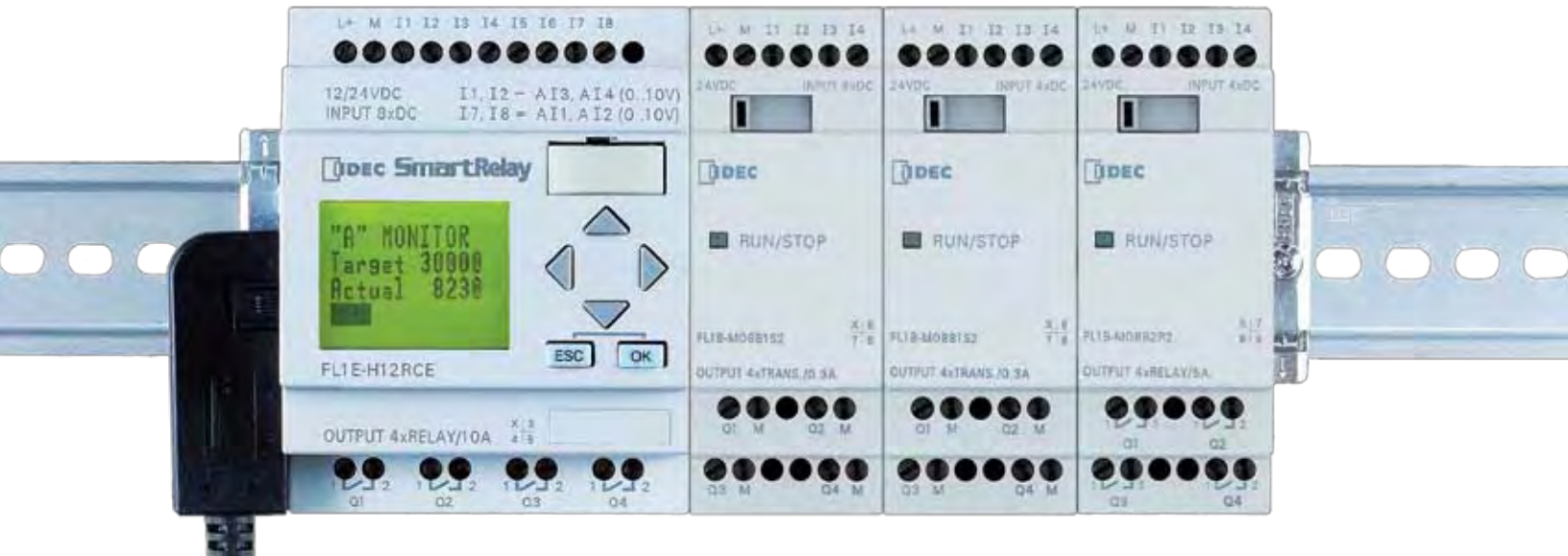

Analog Solutions

IDEC SmartRelay is not limited to simple, digital I/O controls. With four built-in 0-10V analog inputs (compared with only two in FL1D), you don't have to spend more money to connect your analog devices. Inputs I7, I8, I1 and I2 can be configured as analog inputs AI1 through AI4. Additional analog I/O expansion modules can be utilized to allow the FL1E SmartRelay to expand up to 10 analog inputs and 2 analog outputs. Sensors, flow meters, pressure transducers and many other analog devices can be utilized in the SmartRelay system to give you more power and flexibility without added cost!



FL1B-J2B2

- 2-pt analog input module
- Up to four modules can be configured
- Accepts 0-10V DC and 4-20mA input



FL1D-K2B2

- 2-pt analog output module
- Generates 0-10V DC output





LONWORKS® Communication Module FL1B-CL1C12



LonMark, LonWorks, LON, Lon Builder, Neuron, 3120, 3150, and Echelon are registered trademarks of Echelon, USA.

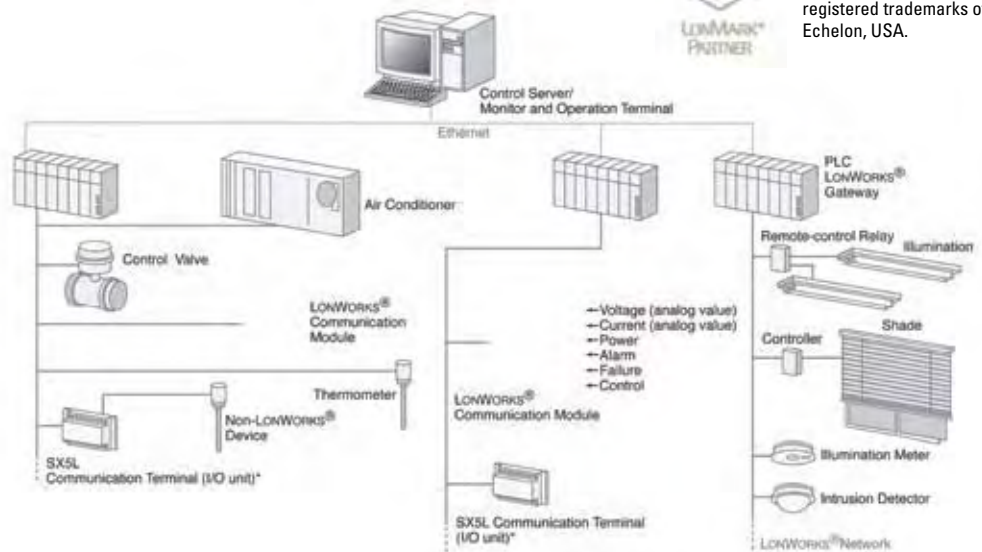

This communication module is an interface for connecting your IDEC SmartRelay to a Local Operating Network (LON). The LonWorks® communication module is a bus station on the LON and allows the IDEC SmartRelay to communicate with other LON devices.



Actuator Sensor-Interface (AS-Interface) Module FL1B-CAS2

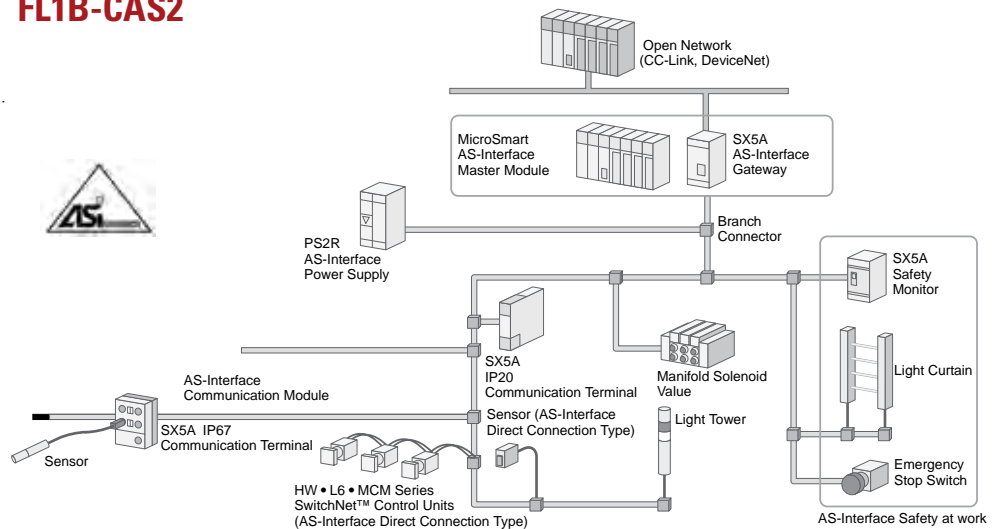

Primarily for control of sensors and actuators at distances of up to 100 meters, this interface utilizes the simplest and most-effective programmable control based industrial networking protocols, used in automation systems worldwide. Reducing the amount of engineering by employing simpler wiring, this module also enhances your operations by requiring little to no maintenance.

Program in seconds

SmartRelay Software

WindLGC is the exclusive programming software for the IDEC SmartRelay using Windows®.



• Create

Create, simulate, test and save your program using drag and drop functions. Eight basic functions make it easy to create a simple switching program in just a matter of seconds, while 31 additional special functions make it just as uncomplicated to create complex programs. Choose function block diagrams or ladder programming; you can always convert from one to the other with the click of an icon.

• Simulate

Offline program simulation (without the need for an actual SmartRelay) enables testing of the entire program from a PC.

• Test

Once you verify your control program works in Simulation Mode, WindLGC allows you to directly monitor your IDEC SmartRelay during operation using an Online Test mode.

• Document

You can create and save your WindLGC program as a PDF, BMP or JPG file. Professional documentation is included with all the necessary configuration information, such as comments and program settings.

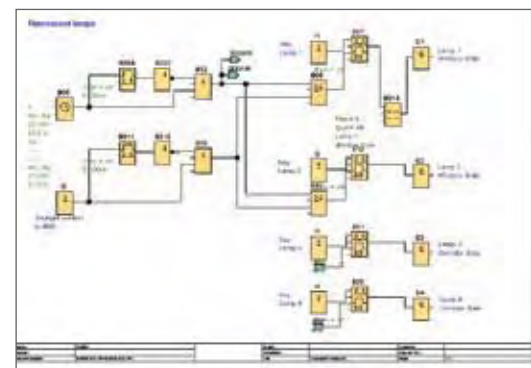
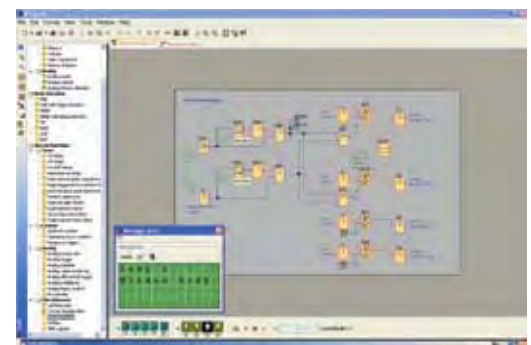
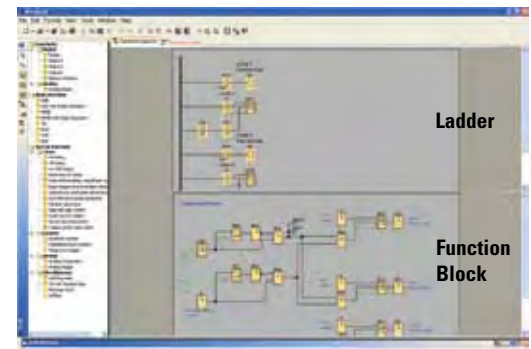

Part numbers

FL1E Base Modules



Part Numbers		Rated Voltage	Input Signal	Input Type	Output Type	With Clock
With LCD Display	FL1E-H12RCE	12/24V DC	DC	PNP	Relay	Yes
	FL1E-H12SND	24V DC			Transistor Source	—
	FL1E-H12RCA	24V AC/DC	AC/DC	NPN/PNP	Relay	Yes
	FL1E-H12RCC	100-240V AC/DC		PNP		
Without LCD Display	FL1E-B12RCE	12/24V DC	DC	PNP	Relay	Yes
	FL1E-B12RCA	24V AC/DC		NPN/PNP		Yes
	FL1E-B12RCC	100-240V AC/DC	PNP			

Text Message Display



Part Number	Rated Voltage	Description
FL1E-RD1	12 VDC, 24 VAC/DC	FL1E SmartRelay Text Display

Communication Modules



Part Numbers	Module	Input Power	Total I/O
FL1B-CL1C12	LonWorks® Communication Module	24V AC/DC	Input: 16 points Analog Input: 8 points Output: 12 points
FL1B-CAS2	AS-Interface Communication Module	30V DC	Input: 4 points Output: 4 points

*LonWorks® is a registered trademark of Echelon

I/O Expansion Modules



Part Numbers	Module	Rated Voltage	Input Type	Output Type	Total I/O
FL1B-M08B2R2	Combination I/O	12/24V DC	PNP	Relay	8 (4 in/4 Out)
FL1B-M08B1S2		24V DC		Transistor	
FL1B-M08C2R2		100-240V AC/DC	NPN/PNP	Relay	
FL1B-M08D2R2		24V AC/DC			
FL1B-J2B2	Analog Input	12/24V DC	0-10V, 4-20mA	—	2 (2 in/0 Out)
FL1D-K2B2	Analog Output	24V DC	—	0-10V	2 (0 in/2 Out)

Starter Kits & Accessories



Part Numbers		Description
Starter Kits	SMARTSTART-BAC-E	FL1E-B12RCC, WindLGC software and programming cable
	SMARTSTART-BDC-E	FL1E-B12RCE, WindLGC software, programming cable, and simulator switch
	SMARTSTART-HAC-E	FL1E-H12RCC, WindLGC software and programming cable
	SMARTSTART-HDC-E	FL1E-H12RCE, WindLGC software, programming cable, and simulator switch
Accessories	FL9Y-LP1CDW	WindLGC 6.0 programming software
	FL1A-PC1	SmartRelay Serial programming cable
	FL1E-PC2	SmartRelay USB programming cable (direct)
	FL1E-PM4	FL1E SmartRelay memory cartridge
	FL1E-PB1	FL1E SmartRelay battery cartridge
	FL1E-PG1	FL1E SmartRelay memory and battery combination cartridge
	FC4A-USB	Serial to USB converter
	FL9Y-B1090-0	FL1E SmartRelay user's manual
	FL1B-Y1371-SW8	8-pt simulator switch, used with 12-24VDC, 24VDC base module only

Your Complete Automation Solution

Our comprehensive line of automation products, along with personalized service and support, provide reliable solutions for even your most complex applications. Everything from precision sensors to high-capacity power supplies, bright and compact touchscreens, our new FL1E SmartRelays and even the fast MicroSmart Pentra are designed to work together to make your job easier. So call IDEC today and get ready to find the customized answer to your specific requirements!



IDEC *Think Automation and beyond...*