

## LCD Hour Meters – Codix 141 / LCD Service Timers – Codix 143

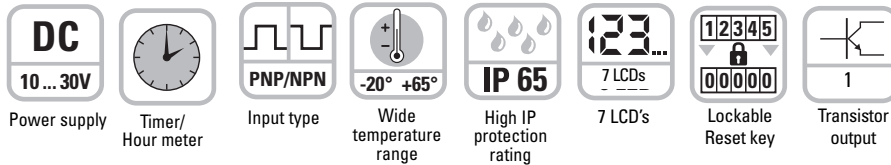

**Codix 141: Standard timer**  
**Codix 143: Service timer**

### User-friendly:

- Power supply 10 ... 30 V DC
- Values stored in EEPROM
- Fixed pre-programmed service intervals  
 e. g.: Service at 5000.00 (Service)  
 Pre-signal at 4900.00 (Pre-service)  
 Blinking text message on the display (Service or Pre-service)
- Multifunctional Reset key, lockable by a separate input.
- The device can also be reset to its delivery condition.



### Simple:

- Fast PNP or damped NPN, Control via separate inputs
- No programming required.

### Functional:

- Direct display of the total time
- Pressing the key displays the preset service value and its pre-signal
- Preset value output in form of a text on the display and on the transistor output
- Pre-signal for the service intervals in form of a text on the display
- Manual or electrical reset of the display or of the service intervals

Power supply:	10 ... 30 V DC, max. 25 mA
Display:	LCD, 7 digits, height of the figures 8 mm
Undervoltage:	display for $U_b < 8$ V: PO-FAIL and data backup
Data backup:	EEPROM
Start delay:	500 ms
<b>Inputs:</b>	
Input A:	static PNP input
Input B:	static NPN input
Reset key enable input:	static NPN input
Reset:	edge-triggered NPN input (min. 20 ms)
Input resistance:	10 kOhm
Switching level:	low 0 ... 2 V DC high 3,5 ... 30 V DC switching threshold approx. 2,7 V
Operating temperature:	-20 ... +65 °C
Storage temperature:	-25 ... +75 °C
Weight:	40 g

EMC:	Immunity to interference: EN55011 class B Emitted interference EN61000-6-2
Connections:	8-pole screw terminals, pitch 5,08 mm
Housing:	front panel mount DIN 43700, 48 x 24, dark grey, Ral 7021
Protection:	IP65 on the front, IP20 on the back
Cleaning:	the front side may only be cleaned using a soft cloth moistened with water
Shock resistance:	EN 60068-2-27: 100G EN 60068-2-29: 10G
Vibration resistance:	EN 60068-2-6: 10 ... 55 Hz/1 mm/30 min.
Additional data for Codix 143 (Service timer)	
Output:	NPN transistor output, open collector max. output voltage 30 V DC max. output current 50 mA

### Display and inquiry mode Service timer

If the Reset key is not released by means of the activation input of pin 6, pressing the key makes the following functions available to the user.

- Press 1x: The text "SErVICE" is displayed
- Press 2x: The following Service value is displayed
- Press 3x: The text "PrESErV" is displayed
- Press 4x: The following Preservice value is displayed
- Press 5x: The current value is displayed

For the service timers, the values counted remain stored, the service values are incremented by the stored preset value when resetting. E.g. service value 5000.00 h, counter count when resetting 5100.00 h, new service value 10100.00 h.

### Applications:

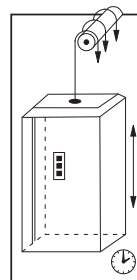

Operating time and service interval

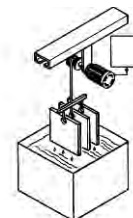

Total time and service interval

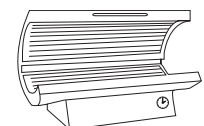

Service interval and total time of the UV lamps

## LCD Hour Meters – Codix 141 / LCD Service Timers – Codix 143

### Dimensions:

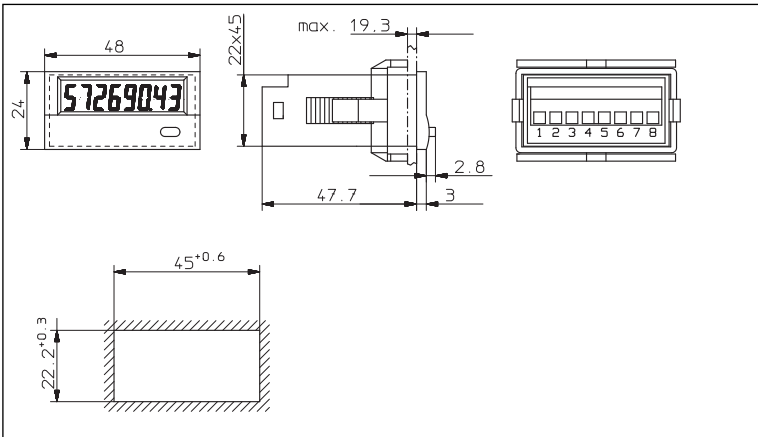

### Delivery specification:

- Counter
- Mounting clip
- Gaskets
- Multilingual operating instructions

### Connections:

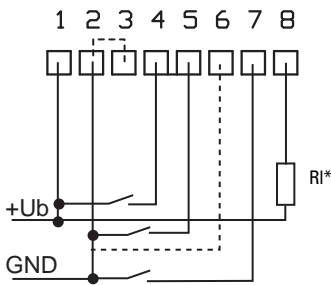

\* Output 8 is only used with Codix 143 as a NPN output

Pin	Description	Standard timer	Service timer
<b>Power supply</b>			
1	+Ub	10 ... 30 V DC	10 ... 30 V DC
2	0 V DC, GND	GND	GND
<b>Inputs</b>			
3	0 V DC, GND	GND	GND
4	Fast counting input	INP PNP	INP PNP
5	Slow counting input	INP NPN	INP NPN
6	Reset enable input	MANUAL RESET ENABLE	MANUAL RESET ENABLE
7	Reset input	RESET	RESET
<b>Output</b>			
8	NPN output	n.c.	OUT

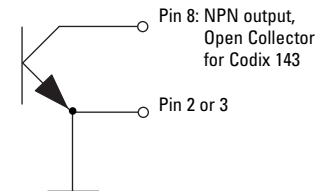

Timers

### Order code - Standard timer

**6.141.012.300**

### Order code - Service timer:

**6.143.011.300.005K.00**

#### Option 1\*

00 = Pre-warning at 100.00 before the preset service value PrESerV and SErVICE

#### Option 2\*

Service range 005K=> 5000.00 h

\* Attention: the following order code is only an example. The option 1 and 2 can be programmed according to customer needs.

#### Please note:

The min. order quantity for custom versions is 10 pcs with an extra charge, or 200+ pcs with no extra charge.

#### Stock models:

6.141.012.300  
6.143.011.300.005k.00