

FX-7

SERIES

Slim Body with Automatic Sensitivity Setting

FZ-10

FX-7

FX-10

FX-11A

CX-20

CX-30

CX-ND300R

EX-10

EQ-20

EQ-30

EX-40

RX

RX-LS200

Fiber Sensor

Amplifier Built-in Type

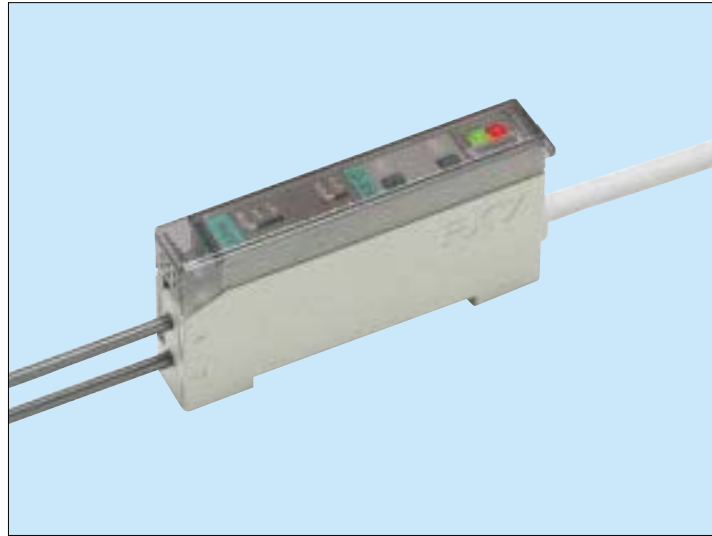

Compact Size with
Advanced Sensing
Technology

CE Marked

Conforming to EMC directive

Thickness : 10mm

Just 10mm thick. Even a number of FX-7 amplifiers save space.

Only 100mm wide with 10 units

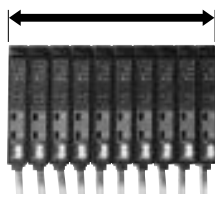

W10 × H31.5 × D59mm

Sensitivity : 8 Times Higher than Before

The FX-7 amplifier performs precise and accurate sensing 8 times greater than a conventional model. It can be used not only to detect the presence of an object, but also to discriminate color, or find a thin film overlap. Complicated and sophisticated application needs are relied on the FX-7.

The FX-7 series also provides the green LED amplifier that is eligible for applications much delicate.

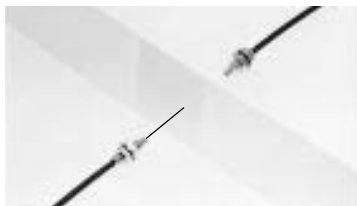

Easily detects translucent film overlap.

Long Sensing Range

The standard M4 fiber offers the sensing range of 600mm.

Thru-beam mode

M4 standard • long sensing range fiber FT-B8



With lens attachments
(FX-LE2 + FT-FM10)

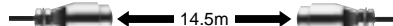

Reflective mode

M6 standard • long sensing range fiber FD-B8



Sensitivity Shift

If either one of the Light state or the Dark state is unstable but the other is stationary, the threshold level can be shifted from the center between the set ON and OFF levels to the stationary side.

Automatic Sensitivity Setting

Anyone can set on optimum sensitivity by just pressing buttons. Even if its power is turned off, the EEPROM memory saves your set sensitivity.

Press the "ON" button with an object

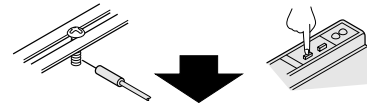

Press the "OFF" button with no object

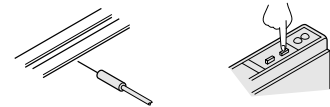

Stability Margin Indication

The number of blinks of the stability indicator represents the stability margin that you have set the sensitivity.

Number of blinks	0	1	2	3	4	5
Margin (%) Margin near by (threshold level)	Under 15	15 to 30	30 to 45	45 to 60	60 to 75	Over 75

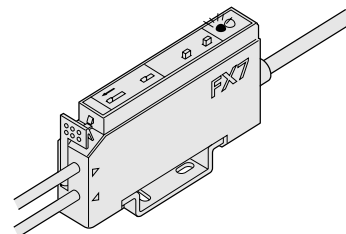

APPLICATIONS

Detecting wafer

The **FD-L42** convergent sensing fiber securely detects a wafer without any affection of color or glossiness of the surface.

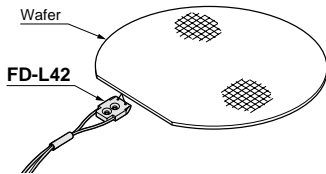

Wafer in vacuum chamber

The vacuum fiber kit composed of the inner fiber, the joint fiber, and the outer fiber detects a wafer inside a vacuum chamber with air-tightness.

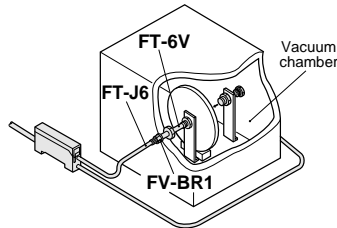

Detecting wafers in cassette

The opening angle of the **FT-K2** or the **FT-KV2** is only 4° so that it securely detects wafers in a cassette individually.

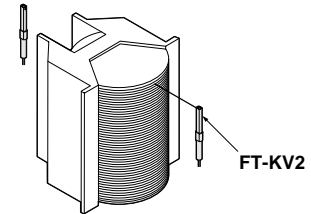

Detecting clock hands

The **FD-EG1** fiber and the **FX-MR3** spot lens produce the smallest projection area of 0.3mm diameter.

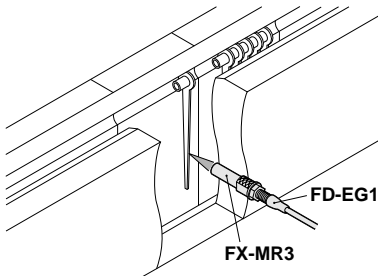

Presence of glass board

The **FD-L41** securely detects the nearest glass board only.

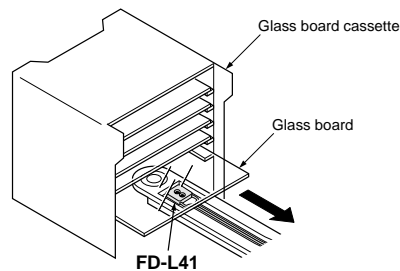

Seam on can

The **FD-AFM2E** array fiber accurately detects a seam on a can because of its line focusing.

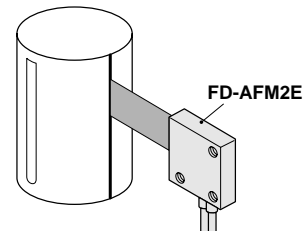

External Synchronization (FX-75 only)

The **FX-75** is incorporated with the trigger function, either gate or edge trigger is available.

With only a synchronizing sensor directly connected to the **FX-75**, the synchronous detection is realized without any other controller.

<For IC orientation detection>

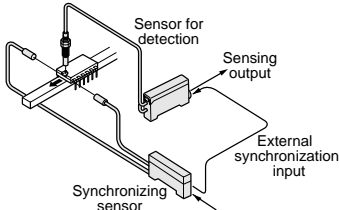

Off-delay Timer (FX-7 & FX-77 only)

Each of the **FX-7** and the **FX-77** is incorporated with the OFF-delay timer, for approx. 40ms fixed.

It is useful when the output signals are so quick and short that a connected device can not take in, for example, by slow scanning time of a device or miniature object detection on a fast production line.

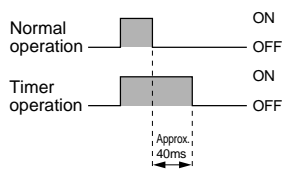

Test Input (FX-75 only)

The **FX-75** is incorporated with the test input that makes beam emission stop. It is useful to check for the operability before start-up.

<When using thru-beam fiber>

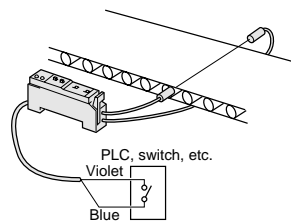

Remote Sensitivity Adjustment (FX-77 only)

As the sensitivity can be set with two remote switches from the amplifier, your production change-over becomes smooth.

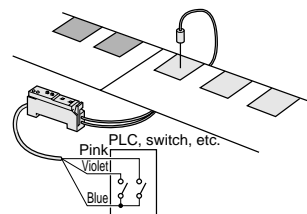

New Fibers

The **FD-L41** for detecting glass boards, the **FD-L42** for detecting wafers or specular objects, the **FT-K2** for detecting wafers in a cassette by the sharp beam (opening angle 4°), and the **FT-KV2** as the side-view type of the **FT-K2**.

Plug-in Connector Type

The **FX-7** amplifier with the plug-in connector on the tail can be connected with the **SL-BM** or the **SL-BX** of the sensor & wire-saving link system **S-LINK**; the **SL-BMW** or the **SL-BW** of the sensor block for simple wiring; or the **CN-54-C2** or the **CN-54-C5** mating cable at a touch.

Refer to the details of the **S-LINK** system on P.582~, the sensor block for simple wiring on P.626~.

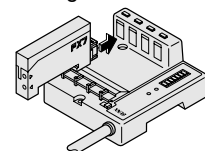

FX-7

ORDER GUIDE

For general use fibers [Thru-beam mode (One pair of two fibers a set)]



Type	Shape of fiber head (mm)	Sensing range (*1) ■ : Red LED type □ : Green LED type	Min. sensing object [on optimum condition (*2)] ① : Red LED type ② : Green LED type	Features	Fiber cable length	Model No.
Standard	Lens applicable 	40mm 600mm	① φ0.16mm opaque object ② φ0.16mm opaque object	• Twice longer sensing range than before	Free Cut 2m	FT-B8
	Lens applicable 	25mm 320mm	① φ0.08mm opaque object ② φ0.08mm opaque object	• Free-cut type	Free Cut 2m	FT-FM2
	With sleeve φ1.48 	25mm 320mm	① φ0.08mm opaque object ② φ0.08mm opaque object			FT-FM2S With sleeve 90mm
	φ2.5 	25mm 320mm	① φ0.08mm opaque object ② φ0.08mm opaque object			FT-FM2S4 With sleeve 40mm
Small fiber head	Lens applicable 	25mm 320mm	① φ0.08mm opaque object ② φ0.08mm opaque object	• Miniature but the same sensing range as the standard type	Free Cut 2m	FT-T80
Small diameter	Lens applicable 	7mm 80mm	① φ0.05mm opaque object ② φ0.03mm opaque object	• Mountable in a tight area or a narrow space • Free-cut type	Free Cut 2m	FT-NFM2
	With sleeve φ0.88 	7mm 80mm	① φ0.05mm opaque object ② φ0.03mm opaque object			FT-NFM2S With sleeve 90mm
	φ1.5 	7mm 80mm	① φ0.05mm opaque object ② φ0.03mm opaque object			FT-NFM2S4 With sleeve 40mm
Flexible	Lens applicable Small diameter 	6mm 90mm	① φ0.05mm opaque object ② φ0.08mm opaque object	• Small diameter fiber head with coiled cable	2m	FT-C4
	Lens applicable 	25mm 320mm	① φ0.08mm opaque object ② φ0.08mm opaque object	• Allowable bending radius : R4mm or more • Bending durability : One million times or more	Free Cut 2m	FT-P80
	Small diameter 	6mm 100mm	① φ0.05mm opaque object ② φ0.08mm opaque object			FT-P40
	Small diameter φ1.5 	7mm 120mm	① φ0.08mm opaque object ② φ0.08mm opaque object			FT-P2 (*3)

Environmental-resistant fibers [Thru-beam mode (One pair of two fibers a set)]



Type	Shape of fiber head (mm)	Sensing range (*1) ■ : Red LED type □ : Green LED type	Min. sensing object [on optimum condition (*2)] ① : Red LED type ② : Green LED type	Features	Fiber cable length	Model No.
Heat-resistant	Lens applicable 	20mm 270mm	① φ0.12mm opaque object ② φ0.08mm opaque object	• Heat-resistant : 350°C • Cold-resistant : -60°C	2m	FT-H35-M2
	With sleeve φ2.1 	20mm 270mm	① φ0.12mm opaque object ② φ0.08mm opaque object	• Flexible cable with silicon jacket • Heat-resistant : 200°C • Cold-resistant : -60°C	1m	FT-H35-M2S6 With sleeve 60mm
	Lens applicable 	37mm 320mm	① φ0.12mm opaque object ② φ0.12mm opaque object			• Heat-resistant : 130°C • Cold-resistant : -60°C • Free-cut type
Chemical-resistant	φ5.5 	1,500mm	① φ1mm opaque object	• Applicable in chemical solvent • Heat-resistant specification (115°C) • Long sensing range with lenses	2m (Bending R : 30mm)	FT-L8Y
	φ5.5 	300mm	① φ1mm opaque object	• Applicable in chemical solvent • Heat-resistant specification (115°C) • Side-view type	2m (Bending R : 30mm)	FT-V8Y
Vacuum	Lens applicable 	200mm	① φ0.1mm opaque object	• Applicable in vacuum chamber • Heat-resistant : 120°C	1m (Bending R : 200mm)	FT-6V
		100mm	① φ0.1mm opaque object		1m (Bending R : 30mm)	FT-60V

(*1) : The free-cut fibers may reduce the sensing ranges 20% lower than the above specified according to how they are cut off.

(*2) : The optimum condition is specified that the sensitivity is adjusted to have the operation indicator exactly light up at a certain distance in the Light-ON mode.

(*3) : Its model No. has been changed because the shorter plug attachments are provided for the FX-7 connection. The specifications including the sensing range are identical as before.

The vacuum fiber must be used with both the followings.

FT-J6 : Outer fibers in the atmosphere (One pair of two fibers a set)

FV-BR1 : Terminal joints (One pair of two joints a set)

ORDER GUIDE

For special use fibers [Thru-beam mode (One pair of two fibers a set)]



Type	Shape of fiber head (mm)	Sensing range (*1) ■ : Red LED type □ : Green LED type	Min. sensing object [on optimum condition (*2)] ① : Red LED type ② : Green LED type	Features	Fiber cable length	Model No.
Long sensing range with lenses			① ϕ 0.5mm opaque object ② ϕ 0.5mm opaque object	• Large lenses on the tops of the fiber heads expand the sensing range significantly. • Fiber cable length 10m each	Free Cut 10m	FT-FM10L
			① ϕ 0.1mm opaque object ② ϕ 0.08mm opaque object	• Small fiber heads of ϕ 2.5mm with lenses expand the sensing range.	Free Cut 2m	FT-SFM2L
Array	Top sensing 		① Horizontal ϕ 0.05mm opaque object Vertical ϕ 0.3mm opaque object ② Horizontal ϕ 0.03mm opaque object Vertical ϕ 0.3mm opaque object	• The wide beam stripe detects an object at any place within the area.	Free Cut 2m	FT-AFM2
	Side sensing 		① Horizontal ϕ 0.05mm opaque object Vertical ϕ 0.3mm opaque object ② Horizontal ϕ 0.03mm opaque object Vertical ϕ 0.3mm opaque object			FT-AFM2E
Elbow	Lens applicable 		① ϕ 0.08mm opaque object ② ϕ 0.08mm opaque object	• The fiber head is bent at a right angle of 5mm radius at the neck.	Free Cut 2m	FT-R80
Side-view	Small diameter 		① ϕ 0.05mm opaque object	• The side-view sensing enables to use in a tight space.	Free Cut 2m	FT-V22 (*3)
	Sleeve part can not be bent. (ϕ 2 for FT-V22) 		① ϕ 0.05mm opaque object			FT-V41
			① ϕ 0.05mm opaque object ② ϕ 0.08mm opaque object			FT-SFM2SV2
Ultra-small diameter	Sleeve part can not be bent. 		① ϕ 0.01mm opaque object	• Ultra-small diameter heads produce the sharp beam envelope of ϕ 0.125mm.	500mm	FT-E10 (*3)
	Sleeve part can not be bent. 		① ϕ 0.03mm opaque object	• Ultra-small diameter heads produce the sharp beam envelope of ϕ 0.25mm.	1m	FT-E20 (*3)
Narrow beam			① ϕ 0.3mm copper wire ② ϕ 0.3mm copper wire	• Beam-opening angle 4° • Equivalent quality as the laser ray	1m	NEW FT-K2
			① ϕ 0.3mm copper wire	• Beam-opening angle 4° • Side-view type	1m	NEW FT-KV2
		Sleeve part can not be bent.		① ϕ 0.05mm opaque object	• The narrow beam-opening angle, one-sixth of a conventional model, reduces cross-talking.	1m

(*1) : The free-cut fibers may reduce the sensing ranges 20% lower than the above specified according to how they are cut off.

(*2) : The optimum condition is specified that the sensitivity is adjusted to have the operation indicator exactly light up at a certain distance in the Light-ON mode.

(*3) : Its model No. has been changed because the shorter plug attachments are provided for the FX-7 connection. The specifications including the sensing range are identical as before.

Semi-standard fibers (Custom-order made)

The standard fibers can be modified in fiber cable length or in sleeve length based on your request. Select the fiber cable length (symbolized with \boxtimes) or the sleeve length (symbolized with \boxminus) you need from the below table.

Type	Basic model No.	\boxtimes Fiber cable length (Unit : m)	\boxminus Sleeve length (Unit : cm)
Standard of threaded head (Free-cut)	FT-FM \boxtimes	3, 4, 5, 10, 15, 20, 25, 30	—
With sleeve	FT-FM \boxtimes -S \boxminus	2 (*1), 3, 4, 5, 10, 15, 20, 25, 30	1, 2, 3, 4, 5, 6, 7, 8, 9, 10, 11, 12
With large diameter lens	FT-FM \boxtimes L	20, 30	—
Small diameter of threaded head with sleeve (Free-cut)	FT-NFM2-S \boxminus	—	1, 2, 3, 4, 5, 6, 7, 8, 9, 10, 11, 12
200°C heat-resistant	FT-H20-M \boxtimes	2, 3	—
350°C heat-resistant	FT-H35-M \boxtimes	3	—

(*1) : The standard fiber features 2m in fiber cable length and 4cm or 9cm in sleeve length.

Correlation between attenuation factor of sensing range and fiber cable length

The longer the fiber cable is the shorter the sensing range becomes.

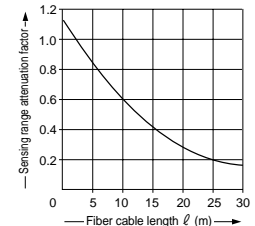

FX-7

ORDER GUIDE

For general use fibers [Reflective mode]

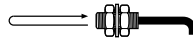

Type	Shape of fiber head (mm)	Sensing range (*1) (*2) ■ : Red LED type □ : Green LED type	Min. sensing object [at the maximum sensitivity (*3)] ① : Red LED type ② : Green LED type	Features	Fiber cable length	Model No.
Standard	Coaxial		① 160mm ② 14mm	• Long sensing range	Free Cut 2m	FD-B8
			① 130mm ② 8mm			
	With sleeve		① 130mm ② 8mm	• Suitable for green LED type	500mm	FD-5 (*4)
Small fiber head	Small diameter		① 130mm ② 8mm	• Miniature but the same sensing range as the standard type	Free Cut 2m	FD-T80
			① 30mm ② 2.5mm			
	Small diameter		① 130mm ② 8mm	① 0.01mm gold wire ② 0.4mm copper wire	• Free-cut type	2m
Small diameter	With sleeve		① 30mm ② 2mm	• Mountable in a tight area or a narrow space • Free-cut type	Free Cut 2m	FD-NFM2 FD-NFM2S With sleeve 90mm FD-NFM2S4 With sleeve 40mm
			① 30mm ② 2mm			
	Small diameter		① 30mm ② 2mm	① 0.01mm gold wire ② 0.4mm copper wire	• Free-cut type	2m
Flexible	Small diameter		① 80mm ② 6mm	• Allowable bending radius : R4mm or more • Bending durability : One million times or more	Free Cut 2m	FD-P80 FD-P40
			① 8mm ② 8mm			
	Small diameter		① 15mm ② 1mm	① 0.01mm gold wire ② 0.4mm copper wire	• Free-cut type	1m

Environmental-resistant fibers [Reflective mode]

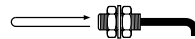

Type	Shape of fiber head (mm)	Sensing range (*1) (*2) ■ : Red LED type □ : Green LED type	Min. sensing object [at the maximum sensitivity (*3)] ① : Red LED type ② : Green LED type	Features	Fiber cable length	Model No.
Heat-resistant	Coaxial		① 88mm ② 9mm	• Heat-resistant : 350°C • Cold-resistant : -60°C	2m	FD-H35-M2 FD-H35-M2S6 With sleeve 60mm
			① 88mm ② 9mm			
	Coaxial		① 88mm ② 11mm	• Flexible cable with silicon jacket • Heat-resistant : 200°C • Cold-resistant : -60°C	1m	FD-H20-M1
	Coaxial		① 88mm ② 11mm	① 0.01mm gold wire ② 1.45mm stainless steel bar	• Heat-resistant : 130°C • Cold-resistant : -60°C • Free-cut type	Free Cut 2m
Vacuum		① 50mm	① 0.1mm copper wire	• Applicable in vacuum chamber • Heat-resistant : 120°C	1m	FD-6V

(*1) : The sensing range is specified with using white non-glossy paper (50 × 50mm). (FD-B8 : 100 × 100mm, FD-SFM2SV2 : 30 × 30mm, FD-KM1S2 : 10 × 10mm)

(*2) : The free-cut fibers may reduce the sensing ranges 20% lower than the above specified according to how they are cut off.

(*3) : The minimum sensing object is obtainable with the maximum sensitivity, but at the ideal sensing distance within the rated sensing range.

(*4) : Its model No. has been changed because the shorter plug attachments are provided for the FX-7 connection. The specifications including the sensing range are identical as before.

The vacuum fiber must be used with both the followings.

FT-J6 : Outer fibers in the atmosphere (One pair of two fibers a set)

FV-BR1 : Terminal joints (One pair of two joints a set)

ORDER GUIDE

For special use fibers [Reflective mode]

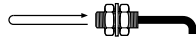

Type	Shape of fiber head (mm)	Sensing range (*1) (*2) ■ : Red LED type □ : Green LED type	Min. sensing object [at the maximum sensitivity (*3)] ① : Red LED type ② : Green LED type	Features	Fiber cable length	Model No.
Convergent reflective Glass board detection Wafer or special object detection	18 × 14	4.5 to 8mm (Center : 6mm)	① φ0.01mm gold wire	• The optical system cancels affection by color or surface condition of an object.	Free Cut 2m	FD-L4
	24 × 21	3 to 13mm (Center : 8mm)	① φ0.2mm copper wire	• Just 4mm thick • Glass board is securely detected.		NEW FD-L41
	15 × 19	Center : 2mm	① φ0.5mm copper wire	• Just 3mm thick • Wafer is securely detected.		NEW FD-L42
High precision	Lens applicable Coaxial	M4 44mm	① φ0.01mm gold wire	• The coaxial fiber gives precise and symmetrical sensing.	Free Cut 2m	FD-G4
	Lens applicable Coaxial • Small diameter	M3 13mm	① φ0.01mm gold wire	• The combination with the FX-MR3 lens gives the smallest spot diameter of approx. φ0.3mm.	500mm	FD-G500
Array	Top sensing	□20 66mm	① Horizontal φ0.01mm gold wire ② Vertical φ0.05mm copper wire	• Its wide and flat detection area enables to detect objects traveling through inexactly.	Free Cut 2m	FD-AFM2
	Side sensing	4mm	① Horizontal φ0.08mm copper wire ② Vertical φ1.45mm stainless steel bar			FD-AFM2E
Elbow		M6 5mm 66mm	① φ0.01mm gold wire ② φ2.1mm stainless steel bar	• The fiber head is bent at a right angle of 5mm radius at the neck.	Free Cut 2m	FD-R80
Side-view	Small diameter	φ1.5 φ3 15mm	① φ0.02mm gold wire	• The side view sensing enables to use in a tight space.	Free Cut 2m	FD-V41
	Sleeve part can not be bent.	φ2 φ5 2mm 24mm	① φ0.02mm gold wire ② φ2.1mm stainless steel bar			FD-SFM2SV2
Ultra-small diameter	Sleeve part can not be bent.	φ0.5 M3 1.5mm	① φ0.01mm gold wire	• Mountable in a complex area	500mm	FD-EN500S1
	Coaxial Sleeve part can not be bent.	φ0.8 M3 13mm	① φ0.01mm gold wire	• The coaxial fiber gives precise and symmetrical sensing.	1m	FD-ENM1S1
Narrow-view	Coaxial Sleeve part can not be bent.	φ2 M5 9mm	① φ0.02mm gold wire	• The narrow beam-opening angle, one-sixth of a conventional model, makes a small detecting area.	1m	FD-KM1S2
Liquid level detection	Mountable on pipe	φ6 φ5	① (Liquid)	• Liquid drop on the top never affects the sensing.	Free Cut 2m	NEW FD-F8Y
		25 × 20 Applicable pipe diameter : φ6 to φ26mm PFA (Fluorine resin) or the equivalent bearing the same transparency thickness 1mm	① (Liquid)	• Liquid surface is securely detected from the outside of a pipe.	Free Cut 2m Free Cut 5m	NEW FD-F4 NEW FD-F9

(*1) : The sensing range is specified with using white non-glossy paper (50 × 50mm). (FD-B8 : 100 × 100mm, FD-SFM2SV2 : 30 × 30mm, FD-KM1S2 : 10 × 10mm)

(*2) : The free-cut fibers may reduce the sensing ranges 20% lower than the above specified according to how they are cut off.

(*3) : The minimum sensing object is obtainable with the maximum sensitivity, but at the ideal sensing distance within the rated sensing range.

Semi-standard fibers (Custom-order made)

The standard fibers can be modified in fiber cable length or in sleeve length based on your request. Select the fiber cable length (symbolized with □) or the sleeve length (symbolized with △) you need from the below table.

Type	Basic model No.	□ Fiber cable length (Unit : m)	△ Sleeve length (Unit : cm)
Standard of threaded head (Free-cut)	FD-FM	3, 4, 5, 10, 15, 20	—
With sleeve	FD-FM-S	2 (*1), 3, 4, 5, 10, 15, 20	1, 2, 3, 4, 5, 6, 7, 8, 9, 10, 11, 12
Small diameter of threaded head with sleeve (Free-cut)	FD-NFM2-S	—	1, 2, 3, 4, 5, 6, 7, 8, 9, 10, 11, 12
200°C heat-resistant	FD-H20-M	2, 3	—
350°C heat-resistant	FD-H35-M	3	—

(*1) : The standard fiber features 2m in fiber cable length and 4cm or 9cm in sleeve length.

Correlation between attenuation factor of sensing range and fiber cable length

The longer the fiber cable is, the shorter the sensing range becomes.

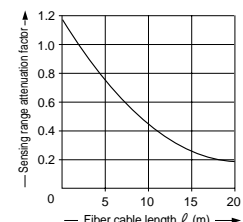

ORDER GUIDE

Amplifiers

Type	Appearance	Model No.	Functions (● : Incorporated)							Emitting element	Output	
			Sensitivity shift	Stability margin indication	External synchronization	Test input	Remote sensitivity adjustment	OFF-delay timer	Crosstalk prevention			
Standard type		FX-7								Red LED	NPN open-collector transistor	
		FX-7P	●	●	—	—	—	●	●		PNP open-collector transistor	
		FX-7G								Green LED	NPN open-collector transistor	
		FX-7GP	●	●	—	—	—	●	●		PNP open-collector transistor	
External synchronization input type		FX-75	●	●	●	●	—	—	●	Red LED	NPN open-collector transistor	
		FX-75G	●	●	—	—	—	—	●	Green LED		
Remote sensitivity adjustment type		FX-77	●	●	—	—	—	—	●	●		Red LED
		FX-77G	●	●	—	—	—	—	●	●		Green LED

Plug-in connector type

Integrated plug-in connector is available on the standard type. (Standard : Cable type)

Model No. : FX-7J, FX-7PJ (Red LED type)

FX-7GJ, FX-7GPJ (Green LED type)

Applicable with the SL-BM or the SL-BX of the sensor & wire-saving link system S-LINK; the SL-BMW or the SL-BW of the sensor block for simple wiring; or the CN-54-C2 or the CN-54-C5 mating cable.

FX-7J
FX-7GJ

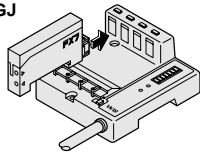

Sensor & wire-saving link system, S-LINK

(Refer to P.582 for details.)

FX-7J, FX-7PJ
FX-7GJ, FX-7GPJ

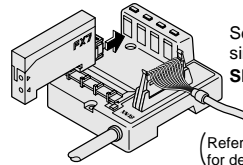

Sensor block for simple wiring SL-BMW/SL-BW

(Refer to P.626 for details.)

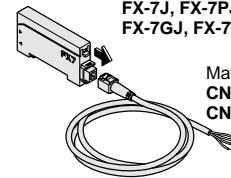

FX-7J, FX-7PJ
FX-7GJ, FX-7GPJ

Mating cable
CN-54-C2 (2m long)
CN-54-C5 (5m long)

PNP output type amplifier can not be connected.

OPTION

Designation	Model No.	Description		
Protective tube (For thru-beam fiber)	FTP-500 (0.5m)	For M4 thread	FT-B8 FT-FM2 FT-FM2S FT-FM2S4	
	FTP-1000 (1m)		FT-P80 FT-H13-FM2	
	FTP-1500 (1.5m)			
	Protective tube (For reflective fiber)	FDP-500 (0.5m)	For M6 thread	FD-B8 FD-FM2 FD-FM2S FD-FM2S4
		FDP-1000 (1m)		FD-P80 FD-H13-FM2
		FDP-1500 (1.5m)		
Protective tube (For reflective fiber)	FDP-N500 (0.5m)	For M3 thread	FT-T80 FT-NFM2 FT-NFM2S FT-NFM2S4	
	FDP-N1000 (1m)			
	FDP-N1500 (1.5m)			
	FDP-N500 (0.5m)		FD-B8 FD-FM2 FD-FM2S FD-FM2S4	
Protective tube (For reflective fiber)	FDP-N1000 (1m)	For M4 thread	FD-T80 FD-NFM2 FD-NFM2S FD-NFM2S4	
	FDP-N1500 (1.5m)			
	FDP-N500 (0.5m)			
	FDP-N1000 (1m)			
Fiber bender	FB-1	The fiber bender curves the sleeve part of the fiber head at the proper radius. (*1)		
Universal sensor mounting stand (*2)	MS-AJ-F	Fiber assemblies (For M3, M4 or M6 threaded head fiber)		

Protective tube



Fiber bender

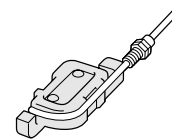

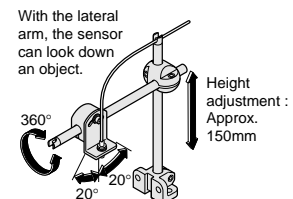

Universal sensor mounting stand



(*1) : Do not bend the sleeve part of any side-view fiber, ultra-small diameter head fiber, or narrow-view fiber.

(*2) : Refer to P.242~ for details of the universal sensor mounting stand.

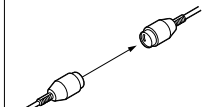
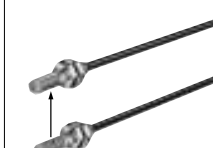
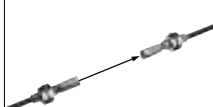
OPTION

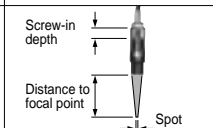
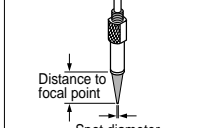
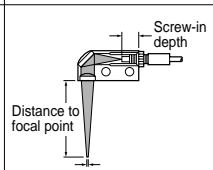
Designation	Model No.	Description																																						
For thru-beam fiber	Expansion lens	FX-LE1	 <p>Six times longer or more • Ambient temperature : - 60 to + 350°C</p>	Sensing range (mm) [Two lenses on both sides] <table border="1"> <thead> <tr> <th>Fiber</th> <th>Applicable amplifier</th> <th>Red LED type</th> <th>Green LED type</th> </tr> </thead> <tbody> <tr><td>FT-B8</td><td></td><td>2,500</td><td>230</td></tr> <tr><td>FT-FM2</td><td></td><td>2,000</td><td>200</td></tr> <tr><td>FT-T80</td><td></td><td>2,000</td><td>200</td></tr> <tr><td>FT-C4</td><td></td><td>540</td><td>90</td></tr> <tr><td>FT-P80</td><td></td><td>2,000</td><td>200</td></tr> <tr><td>FT-H35-M2</td><td></td><td>1,600</td><td>140</td></tr> <tr><td>FT-H20-M1</td><td></td><td>1,600</td><td>140</td></tr> <tr><td>FT-R80</td><td></td><td>1,600</td><td>190</td></tr> </tbody> </table>	Fiber	Applicable amplifier	Red LED type	Green LED type	FT-B8		2,500	230	FT-FM2		2,000	200	FT-T80		2,000	200	FT-C4		540	90	FT-P80		2,000	200	FT-H35-M2		1,600	140	FT-H20-M1		1,600	140	FT-R80		1,600	190
	Fiber	Applicable amplifier	Red LED type	Green LED type																																				
	FT-B8		2,500	230																																				
	FT-FM2		2,000	200																																				
FT-T80		2,000	200																																					
FT-C4		540	90																																					
FT-P80		2,000	200																																					
FT-H35-M2		1,600	140																																					
FT-H20-M1		1,600	140																																					
FT-R80		1,600	190																																					
Super-expansion lens	FX-LE2	 <p>The farthest expansion with large aperture lenses • Ambient temperature : - 60 to + 350°C</p>	Sensing range (mm) [Two lenses on both sides] <table border="1"> <thead> <tr> <th>Fiber</th> <th>Applicable amplifier</th> <th>Red LED type</th> <th>Green LED type</th> </tr> </thead> <tbody> <tr><td>FT-B8</td><td></td><td>3,500 (*1)</td><td>1,400</td></tr> <tr><td>FT-FM2</td><td></td><td>3,500 (*2)</td><td>1,700</td></tr> <tr><td>FT-P80</td><td></td><td>3,500 (*1)</td><td>1,300</td></tr> <tr><td>FT-H35-M2</td><td></td><td>3,500 (*3)</td><td>800</td></tr> <tr><td>FT-H20-M1</td><td></td><td>1,600 (*1)</td><td>900</td></tr> <tr><td>FT-H13-FM2</td><td></td><td>3,500 (*1)</td><td>800</td></tr> <tr><td>FT-R80</td><td></td><td>3,500 (*1)</td><td>1,400</td></tr> </tbody> </table>	Fiber	Applicable amplifier	Red LED type	Green LED type	FT-B8		3,500 (*1)	1,400	FT-FM2		3,500 (*2)	1,700	FT-P80		3,500 (*1)	1,300	FT-H35-M2		3,500 (*3)	800	FT-H20-M1		1,600 (*1)	900	FT-H13-FM2		3,500 (*1)	800	FT-R80		3,500 (*1)	1,400					
Fiber	Applicable amplifier	Red LED type	Green LED type																																					
FT-B8		3,500 (*1)	1,400																																					
FT-FM2		3,500 (*2)	1,700																																					
FT-P80		3,500 (*1)	1,300																																					
FT-H35-M2		3,500 (*3)	800																																					
FT-H20-M1		1,600 (*1)	900																																					
FT-H13-FM2		3,500 (*1)	800																																					
FT-R80		3,500 (*1)	1,400																																					
Side-view lens	FX-SV1	 <p>Beam axis is bent by 90°. • Ambient temperature : - 60 to + 300°C</p>	Sensing range (mm) [Two lenses on both sides] <table border="1"> <thead> <tr> <th>Fiber</th> <th>Applicable amplifier</th> <th>Red LED type</th> <th>Green LED type</th> </tr> </thead> <tbody> <tr><td>FT-B8</td><td></td><td>750</td><td>40</td></tr> <tr><td>FT-FM2</td><td></td><td>400</td><td>35</td></tr> <tr><td>FT-T80</td><td></td><td>400</td><td>35</td></tr> <tr><td>FT-C4</td><td></td><td>120</td><td></td></tr> <tr><td>FT-P80</td><td></td><td>400</td><td>35</td></tr> <tr><td>FT-H35-M2</td><td></td><td>300</td><td>25</td></tr> <tr><td>FT-H20-M1</td><td></td><td>300</td><td>25</td></tr> </tbody> </table>	Fiber	Applicable amplifier	Red LED type	Green LED type	FT-B8		750	40	FT-FM2		400	35	FT-T80		400	35	FT-C4		120		FT-P80		400	35	FT-H35-M2		300	25	FT-H20-M1		300	25					
Fiber	Applicable amplifier	Red LED type	Green LED type																																					
FT-B8		750	40																																					
FT-FM2		400	35																																					
FT-T80		400	35																																					
FT-C4		120																																						
FT-P80		400	35																																					
FT-H35-M2		300	25																																					
FT-H20-M1		300	25																																					
Expansion lens for vacuum fiber	FV-LE1	 <p>Six times longer or more • Ambient temperature : - 60 to + 350°C</p>	Sensing range (mm) [Two lenses on both sides] <table border="1"> <thead> <tr> <th>Fiber</th> <th>Applicable amplifier</th> <th>Red LED type</th> </tr> </thead> <tbody> <tr><td>FT-6V</td><td></td><td>1,200</td></tr> <tr><td>FT-60V</td><td></td><td>600</td></tr> </tbody> </table>	Fiber	Applicable amplifier	Red LED type	FT-6V		1,200	FT-60V		600																												
Fiber	Applicable amplifier	Red LED type																																						
FT-6V		1,200																																						
FT-60V		600																																						
For reflective fiber	Pinpoint spot lens	FX-MR1	 <p>Pinpoint spot of $\phi 0.5\text{mm}$ • Applicable amplifiers : Red LED type • Distance to focal point : $6 \pm 1\text{mm}$ • Applicable fibers : FD-G4 or FD-G500 • Ambient temperature : - 60 to + 300°C</p>																																					
	Zoom lens	FX-MR2	 <p>The spot diameter is adjustable from $\phi 0.7$ to $\phi 2\text{mm}$ according to how much it is screwed in. • Applicable amplifiers : Red LED type • Applicable fibers : FD-G4 & FD-G500 • Ambient temperature : - 40 to + 70°C</p> <table border="1"> <thead> <tr> <th>Screw-in depth</th> <th>Distance to focal point</th> <th>Spot diameter</th> </tr> </thead> <tbody> <tr><td>7mm</td><td>Approx. 18.5mm</td><td>$\phi 0.7\text{mm}$</td></tr> <tr><td>12mm</td><td>Approx. 27mm</td><td>$\phi 1.2\text{mm}$</td></tr> <tr><td>14mm</td><td>Approx. 43mm</td><td>$\phi 2.0\text{mm}$</td></tr> </tbody> </table>	Screw-in depth	Distance to focal point	Spot diameter	7mm	Approx. 18.5mm	$\phi 0.7\text{mm}$	12mm	Approx. 27mm	$\phi 1.2\text{mm}$	14mm	Approx. 43mm	$\phi 2.0\text{mm}$																									
	Screw-in depth	Distance to focal point	Spot diameter																																					
	7mm	Approx. 18.5mm	$\phi 0.7\text{mm}$																																					
12mm	Approx. 27mm	$\phi 1.2\text{mm}$																																						
14mm	Approx. 43mm	$\phi 2.0\text{mm}$																																						
Finest spot lens	FX-MR3	 <p>Finest spot of $\phi 0.3\text{mm}$ (with FD-EG1) • Applicable amplifiers : Red LED type • Applicable fibers : FD-EG1 & FD-G4 • Ambient temperature : - 40 to + 70°C</p> <table border="1"> <thead> <tr> <th>Screw-in depth</th> <th>Distance to focal point</th> <th>Spot diameter</th> </tr> </thead> <tbody> <tr><td>FD-EG1</td><td>$7.5 \pm 0.5\text{mm}$</td><td>Approx. $\phi 0.3\text{mm}$</td></tr> <tr><td>FD-G4</td><td>$7.5 \pm 0.5\text{mm}$</td><td>Approx. $\phi 0.5\text{mm}$</td></tr> </tbody> </table>	Screw-in depth	Distance to focal point	Spot diameter	FD-EG1	$7.5 \pm 0.5\text{mm}$	Approx. $\phi 0.3\text{mm}$	FD-G4	$7.5 \pm 0.5\text{mm}$	Approx. $\phi 0.5\text{mm}$																													
Screw-in depth	Distance to focal point	Spot diameter																																						
FD-EG1	$7.5 \pm 0.5\text{mm}$	Approx. $\phi 0.3\text{mm}$																																						
FD-G4	$7.5 \pm 0.5\text{mm}$	Approx. $\phi 0.5\text{mm}$																																						
Zoom lens (Side-view type)	FX-MR5	 <p>The side-view spot lens FX-MR5 contributes space saving. • Applicable amplifiers : Red LED type • Applicable fibers : FD-G4 & FD-G500 • Ambient temperature : - 40 to + 70°C</p> <table border="1"> <thead> <tr> <th>Screw-in depth</th> <th>Distance to focal point</th> <th>Spot diameter</th> </tr> </thead> <tbody> <tr><td>8mm</td><td>Approx. 13mm</td><td>$\phi 0.5\text{mm}$</td></tr> <tr><td>10mm</td><td>Approx. 15mm</td><td>$\phi 0.8\text{mm}$</td></tr> <tr><td>14mm</td><td>Approx. 30mm</td><td>$\phi 3.0\text{mm}$</td></tr> </tbody> </table>	Screw-in depth	Distance to focal point	Spot diameter	8mm	Approx. 13mm	$\phi 0.5\text{mm}$	10mm	Approx. 15mm	$\phi 0.8\text{mm}$	14mm	Approx. 30mm	$\phi 3.0\text{mm}$																										
Screw-in depth	Distance to focal point	Spot diameter																																						
8mm	Approx. 13mm	$\phi 0.5\text{mm}$																																						
10mm	Approx. 15mm	$\phi 0.8\text{mm}$																																						
14mm	Approx. 30mm	$\phi 3.0\text{mm}$																																						

(*1) : The fiber cable length practically limits the sensing range at 3,500mm long (FT-H20-M1 : 1,600mm).

(*2) : The sensing range can be expanded up to 14.5m with fiber cables 10m long each.

(*3) : The sensing range can be expanded up to 5.5m with fiber cables 3m each.

FX-7

SPECIFICATIONS

Fibers

Item	Type	Heat-resistant			Chemical-resistant	Vacuum	Convergent reflective	Side-view, Narrow beam, Narrow-view, Reflective of ultra-small diameter	Liquid level detection		
		350°C type	200°C type	130°C type						Mountable on pipe	
Allowable bending radius	Standard, Small fiber head, Small diameter, Flexible, Long sensing range with lenses, Array, Elbow, High precision, Thru-beam of ultra-small diameter	R25mm or more (Flexible : R4mm or more, Thru-beam of ultra-small diameter : R5mm or more)			R30mm or more	R200mm or more (FT-60V : R30mm or more)	R10mm or more	R25mm or more (FT-K2 and FT-KV2 : R10mm or more)	Protective tube : R40mm or more Fiber cable : R15mm or more	R10mm or more	
Ambient temperature	-40 to +70°C (FD-EG1 : -20 to +60°C)	-60 to +350°C (*1)	-60 to +200°C	-60 to +130°C	-40 to +115°C	-40 to +120°C	-40 to +70°C (FD-L42 : -40 to +60°C)	-20 to +60°C (FT-V41, FD-V41, FT-K2, and FT-KV2 : -40 to +60°C)	-40 to +125°C (*2)	-40 to +100°C (*2)	
Ambient humidity	35 to 85%RH (No dew condensation nor icing allowed)										
Material	Fiber core	Acrylic	Multi-component glass (*3)		Acrylic	Quartz glass (*3)	Acrylic				
	Sheath	Polyethylene (Thru-beam of ultra-small diameter and Flexible except for FT-C4 and FD-P2 : Vinyl chloride)		Silicone (SUS spiral tube inside)	Fluorine resin		Fluorine resin	Polyethylene Reflective of narrow-view type : Polyurethane, FT-K2 and FT-KV2 : Polyolefine		Polypropylene	
Material	Fiber head	Brass : Threaded part of standard, (Nickel plated) Threaded part of small diameter, High precision, FT-C4, Threaded part of thru-beam of ultra-small diameter, FT-P80, FD-P80, Array, Threaded part of FT-R80 SUS : FT-SFM2, Small fiber head, FT-SNFM2, FD-SNFM2, FT-SFM2L, FT-P40, FT-P2, FD-P40, FD-P2, Sleeve part of sleeve-attached fiber ABS : FT-FM10L (Lens : Acrylic) Zinc alloy die-casted : Threaded part of FD-R80	SUS	Brass (Nickel plated)	Brass (Nickel plated)	Protective tube : Fluorine resin (*4) Fiber sheath : Polypropylene	Aluminum	ABS : FD-L4, FD-L41, FD-L42 (Lens : Acrylic) Aluminum : FD-L42 (Lens : Acrylic)	SUS (FT-KV2 and Thru-beam of FD-EN500S1, FD-ENM1S1, FT-KM1S2 and FD-KM1S2 : Brass Lens of FT-K2 : Glass Lens of FT-KV2 : Acrylic)	Protective tube : Fluorine resin Sheath : Polypropylene	Polyetherimido
	Accessories	Threaded head fiber : 2 pcs. of nuts (thru-beam type : 4 pcs.) and 1 pc. of toothed lock washer (thru-beam type : 2 pcs.) Free-cut type, flexible coiled fiber, chemical-resistant fiber and liquid level detection fiber : 1 pc. of FX-CT1 (Fiber cutter) Small diameter of free-cut fiber, convergent reflective fiber, high precision of free-cut fiber, FD-F4 and FD-F9 : 2 sets of plug attachments (FD-L41, FD-L42, FD-F4 and FD-F9 : 1 set of attachments) FD-F4 and FD-F9 : 4 pcs. of tying bands and 2 pcs. of anti-slip tubes FD-L4 : 2 pcs. of M2.6 × 12mm screws with washers and 2 pcs. of nuts									

(*1) : If the fiber is used under -30°C, its resistable maximum temperature drops to +200°C. If the side-view lens FX-SV1 is put on the fiber head, the allowable maximum temperature comes down to +300°C. (The ambient temperature range of the FX-SV1 is from -60 to +300°C.)

(*2) : With the liquid level detection fiber, also make sure of the temperature of the liquid in which the fiber is immersed.

(*3) : Keep the fiber composed of multi-component glass or quartz glass from vibration or impact.

SPECIFICATIONS

Amplifiers

Item	Model No.	Type	NPN output				PNP output			
		Standard type	External synchronization input type	Remote sensitivity adjustment type	Standard type					
		FX-7	FX-7G	FX-7S	FX-7SG	FX-7T	FX-7TG	FX-7P	FX-7GP	
Supply voltage		12 to 24V DC \pm 10% Ripple P-P 10% or less								
Current consumption		30mA or less								
Sensing output		NPN open-collector transistor • Maximum sink current : 100mA • Applied voltage : 30V DC or less • Residual voltage : 1.0V or less (at 100mA sink current) 0.4V or less (at 16mA sink current)					PNP open-collector transistor • Maximum source current : 100mA • Applied voltage : 30V DC or less • Residual voltage : 2.0V or less (at 100mA source current) 1.0V or less (at 16mA source current)			
Utilization category		DC-12 or DC-13								
Output operation		Selectable either Light-ON or Dark-ON with the order of pressing ON and OFF buttons (Selectable with the external inputs on the FX-7T or the FX-7TG)								
Short-circuit protection		Incorporated								
Self-diagnosis output		NPN open-collector transistor • Maximum sink current : 50mA • Applied voltage : 30V DC or less • Residual voltage : 1.0V or less (at 50mA sink current) 0.4V or less (at 16mA sink current)					PNP open-collector transistor • Maximum source current : 50mA • Applied voltage : 30V DC or less • Residual voltage : 2.0V or less (at 50mA source current) 1.0V or less (at 16mA source current)			
Output operation		ON under the unstable sensing condition and it is restored automatically after approx. 40ms; also ON if the sensing output is short-circuited until it is removed (The remote sensitivity adjustment type makes it turned ON for approx. 40ms after the remote sensitivity input is received.)								
Short-circuit protection		Incorporated								
Response time		0.5ms or less (0.7ms or less when the crosstalk prevention function is used)								
Operation indicator		Red LED (lights up when the sensing output is activated)								
Stability indicator		Green LED (<ul style="list-style-type: none"> "RUN" mode : Lights up at the stable Light condition or the stable Dark condition "SET" mode : Blinks twice when the difference between ON and OFF levels is greater than the hysteresis, but 15 times when it is equal to or less than the hysteresis after the completion of the sensitivity setting. Also blinks twice after the crosstalk prevention is set "SET" mode \rightarrow "SIF" or "RUN" mode : Blinks from 0 to 5 times according to the operation margin)								
Test input function		Incorporated								
External synchronization function		Incorporated (Either gate or edge trigger is selectable)								
Remote sensitivity adjustment function		Incorporated								
Sensitivity shift function		Shifts the sensitivity setting level								
Crosstalk prevention function		Incorporated								
Timer function		Fixed OFF-delay timer approx. 40ms (switchable either effective or ineffective)				Fixed OFF-delay timer approx. 40ms (switchable either effective or ineffective)				
Environmental resistance	Pollution degree	3 (Industrial environment)								
	Ambient temperature	- 10 to + 50°C (No dew condensation nor icing allowed), Storage : - 20 to + 70°C								
	Ambient humidity	35 to 85%RH, Storage : 35 to 85% RH								
	Ambient illuminance (Extraneous light immunity)	Sun light : 10,000lx at the light-receiving face, Incandescent light : 3,000lx at the light-receiving face								
	EMC	Emission : EN50081-2, Immunity : EN50082-2								
	Voltage withstandability	1,000V AC for one min. between all terminals connected and enclosure (*1)								
	Insulation resistivity	20M Ω or more at 250V DC Megger between all terminals connected and enclosure (*1)								
Vibration-proof	10 to 150Hz frequency, 0.75mm amplitude, and X, Y, and Z directions each for two hours (unenergized)									
Shock-proof	98m/s ² acceleration (approx. 10G), and X, Y, and Z directions each for five times (unenergized)									
Emitting element	Red LED (modulated)	Green LED (modulated)	Red LED (modulated)	Green LED (modulated)	Red LED (modulated)	Green LED (modulated)	Red LED (modulated)	Green LED (modulated)		
Material	Enclosure : Heat-resistant ABS, Case cover : Polycarbonate, Fiber lock lever : PPS									
Cable	Cabletyre cable 2m long with six 0.15mm ² conductors (FX-7, FX-7G, FX-7P or PX-7GP : four 0.2mm ² conductors)									
Cable extension	Maximum extension is 100m overall with an equivalent cable with conductors 0.3mm ² or more									
Weight	Approx. 65g									
Accessory	MS-DIN-2 (Mounting bracket) : 1pc.									

(*1) : The voltage withstandability and the insulation resistivity described in the above table are inherent in the amplifier only.

FZ-10

Fiber Sensor
FX-7

FX-10

FX-11A

CX-20

CX-30

CX-ND300R

CX-ND300R

EX-10

EX-20

EQ-20

EQ-30

EQ-40

EX-40

RX

RX-LS200

FX-7

I/O CIRCUIT AND WIRING DIAGRAMS

**FX-7 FX-7G
FX-7J FX-7GJ** Standard type·NPN output

I/O circuit diagram

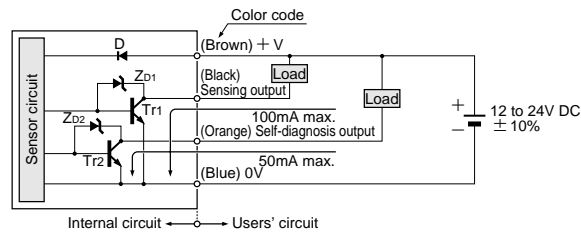

Symbol . . . D : Reverse polarity protection diode
ZD1, ZD2 : Surge absorption zener diode
Tr1, Tr2 : NPN output transistor

Wiring diagram

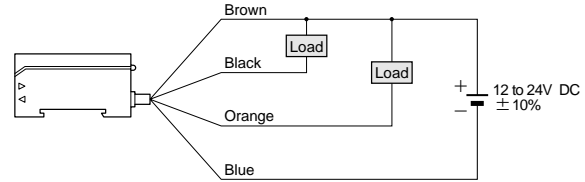

**FX-75
FX-75G**

External synchronization input type

I/O circuit diagram

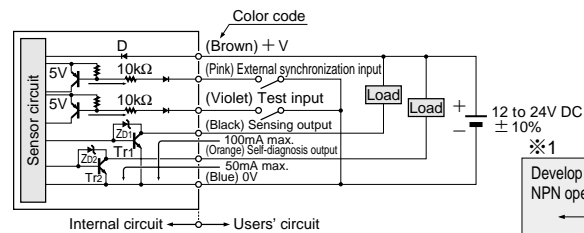

Symbol . . . D : Reverse polarity protection diode
ZD1, ZD2 : Surge absorption zener diode
Tr1, Tr2 : NPN output transistor

Wiring diagram

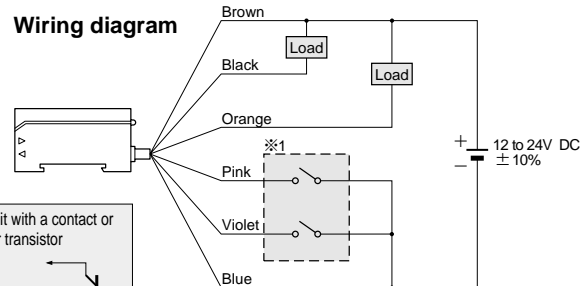

※1
Develop short-circuit with a contact or
NPN open-collector transistor

Low : 0 to 1V
High : 4.5 to 30V or Open

**FX-77
FX-77G**

Remote sensitivity adjustment type

I/O circuit diagram

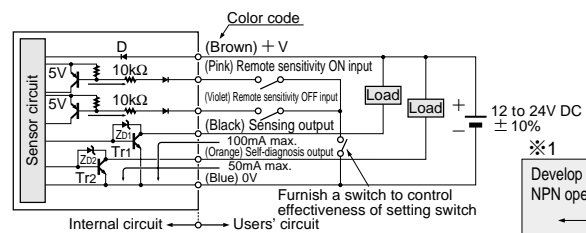

Symbol . . . D : Reverse polarity protection diode
ZD1, ZD2 : Surge absorption zener diode
Tr1, Tr2 : NPN output transistor

Wiring diagram

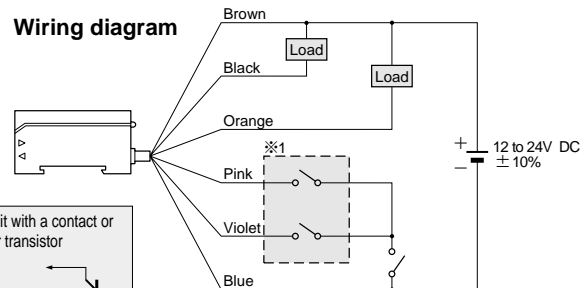

※1
Develop short-circuit with a contact or
NPN open-collector transistor

Low : 0 to 1V
High : 4.5 to 30V or Open

**FX-7P FX-7GP
FX-7PJ FX-7GPJ**

Standard type·PNP output

I/O circuit diagram

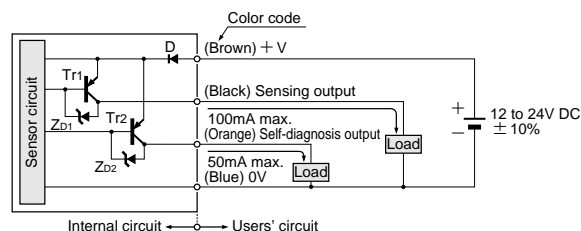

Symbol . . . D : Reverse polarity protection diode
ZD1, ZD2 : Surge absorption zener diode
Tr1, Tr2 : PNP output transistor

Wiring diagram

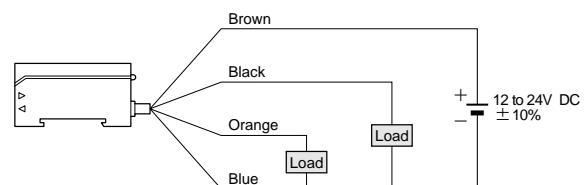

SENSING FIELDS (TYPICAL)

Correlation between setting distance and excess gain

FT-FM2 Thru-beam

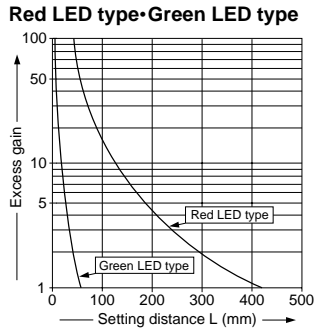

FD-FM2 Reflective

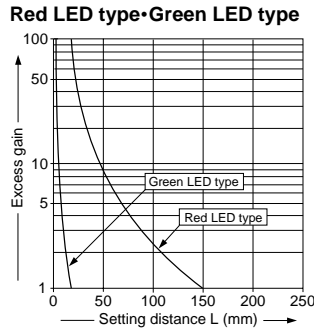

Parallel deviations

FT-B8 Thru-beam

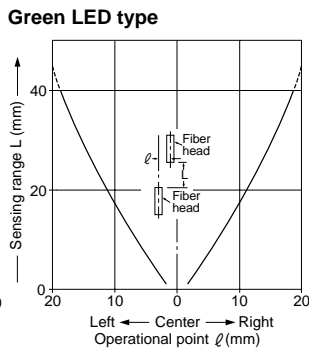
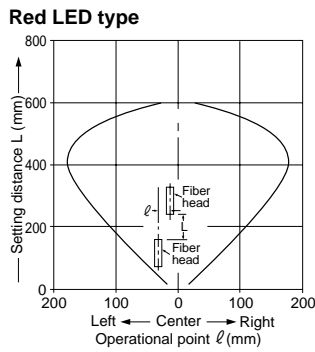

FT-FM2 FT-FM2S FT-FM2S4 FT-SFM2 FT-T80 Thru-beam

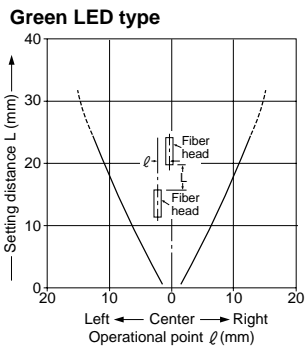
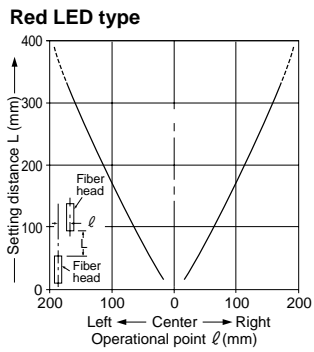

FT-NFM2 FT-NFM2S FT-NFM2S4 FT-SNFM2 Thru-beam

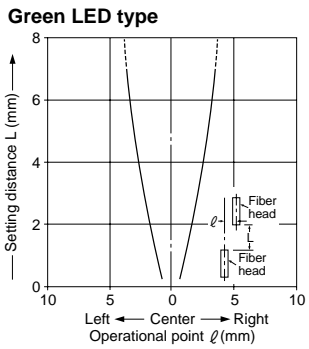
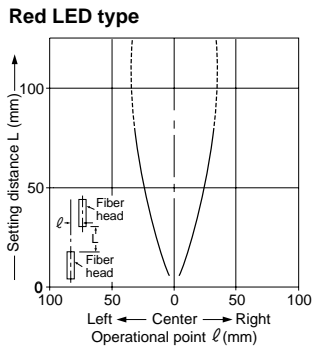

FT-C4 Thru-beam

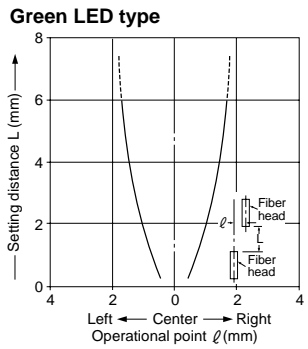
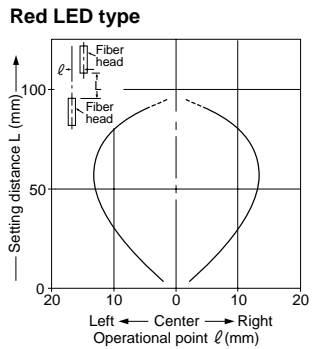

FT-P80 Thru-beam

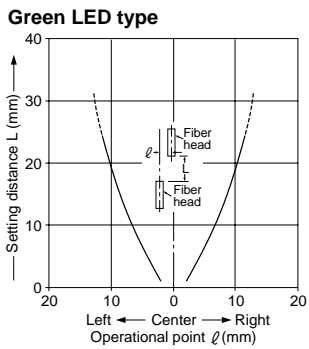
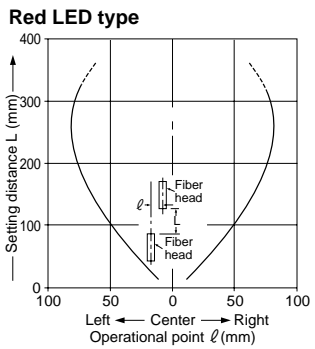

FT-P40 Thru-beam

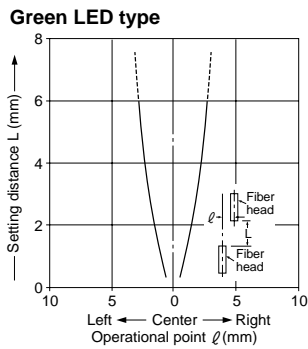
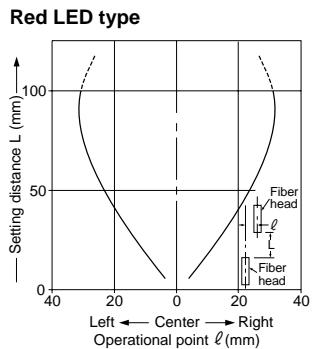

FZ-10

Fiber Sensor FX-7

Fiber Sensor FX-10

Fiber Sensor FX-11A

CX-20

CX-30

CX-ND300R

EX-10

Amplifier Built-in Type EQ-20

EQ-30

EX-40

RX

RX-LS200

FX-7

SENSING FIELDS (TYPICAL)

Parallel deviations

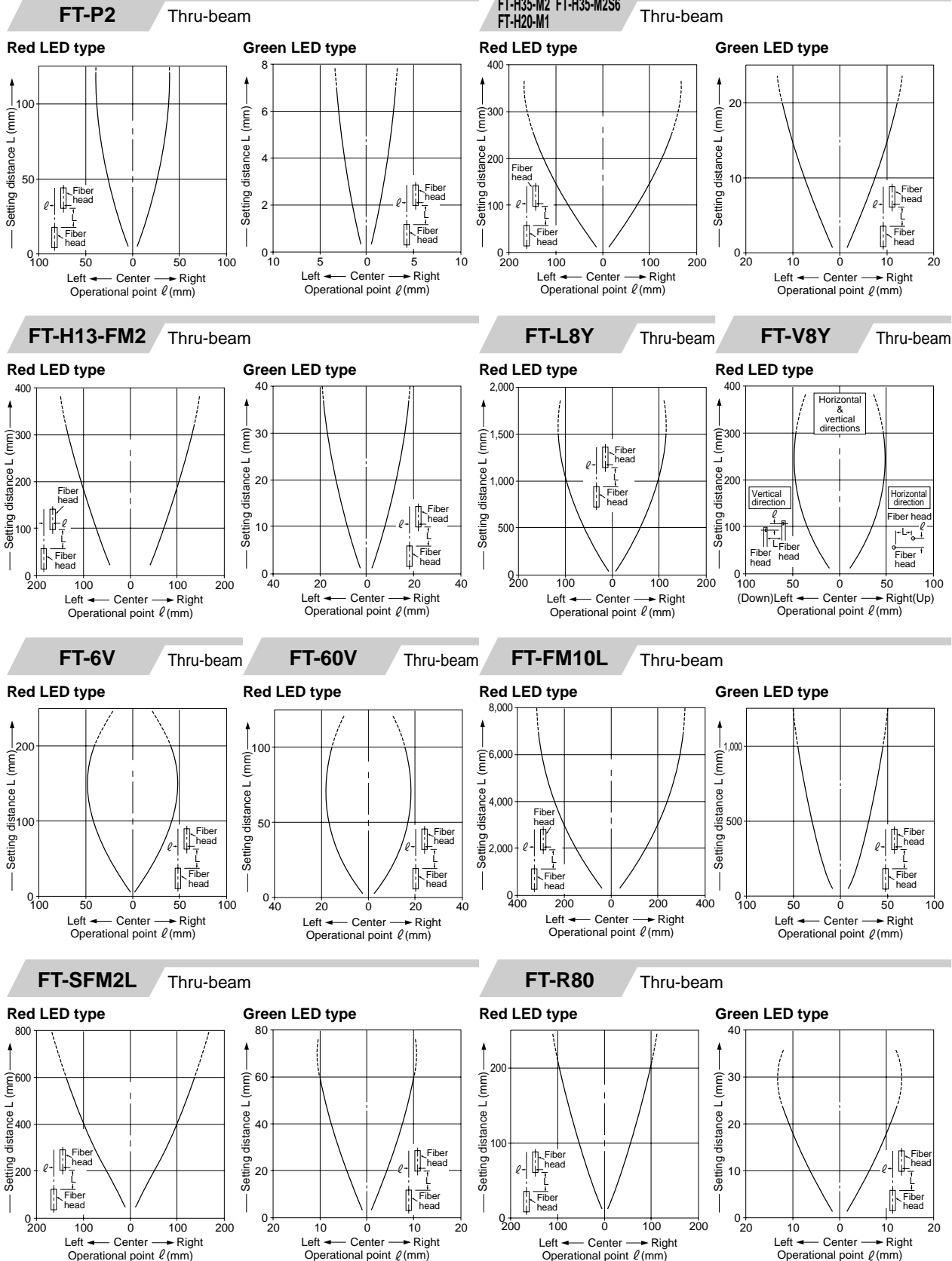

SENSING FIELDS (TYPICAL)

Parallel deviations

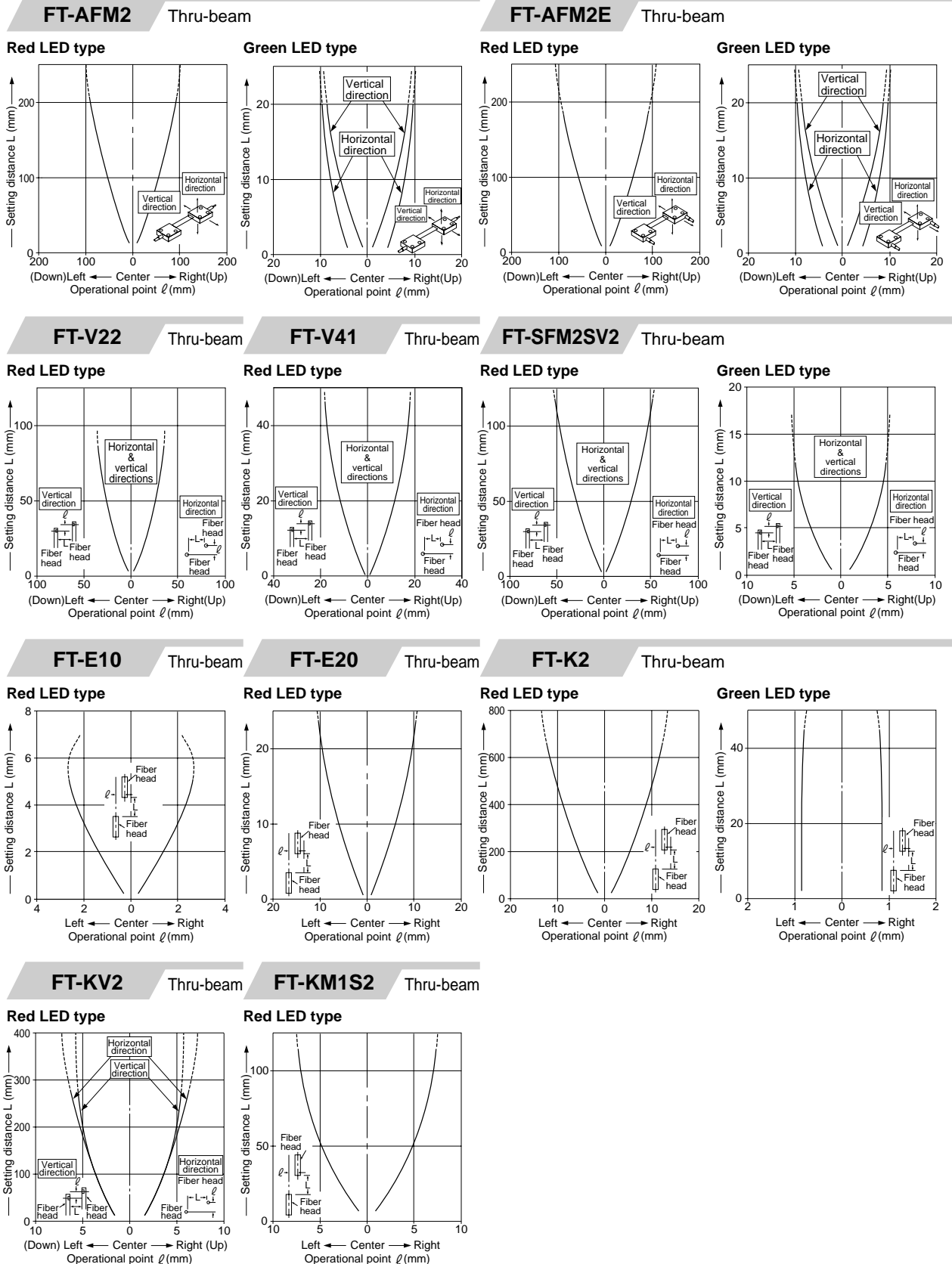

FZ-10

Fiber Sensor
FX-7

FX-10

FX-11A

CX-20

CX-30

CX-ND300R

Amplifier Built-in Type
EX-10

EQ-20

EQ-30

EX-40

RX

RX-LS200

SENSING FIELDS (TYPICAL)

Parallel deviations with FX-LE1 (Expansion lens) applied on both sides

FT-B8 Thru-beam

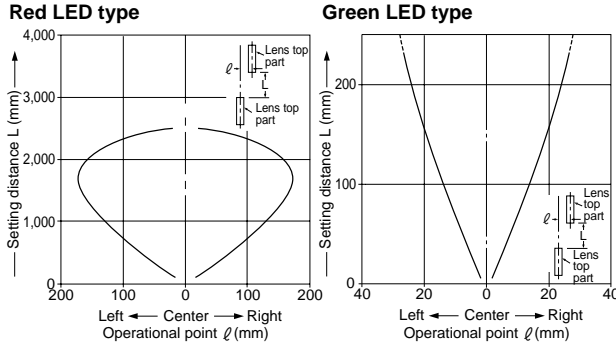

FT-FM2
FT-T80 Thru-beam

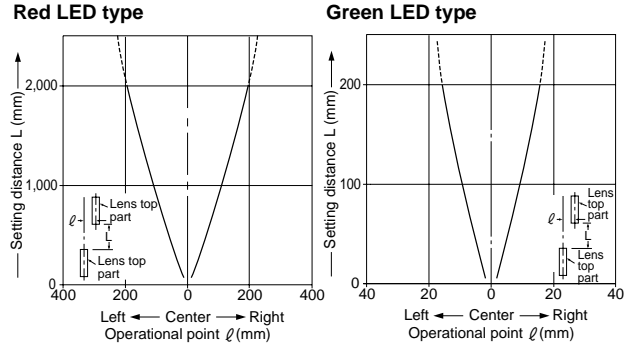

FT-C4 Thru-beam

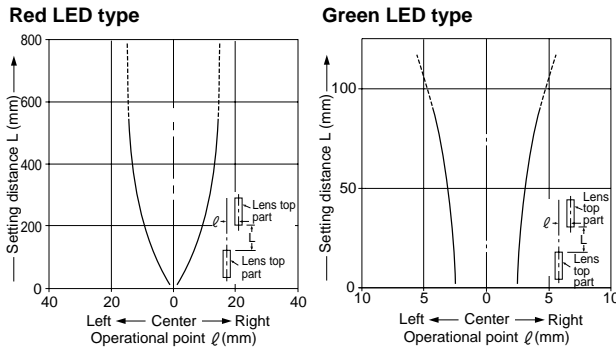

FT-P80 Thru-beam

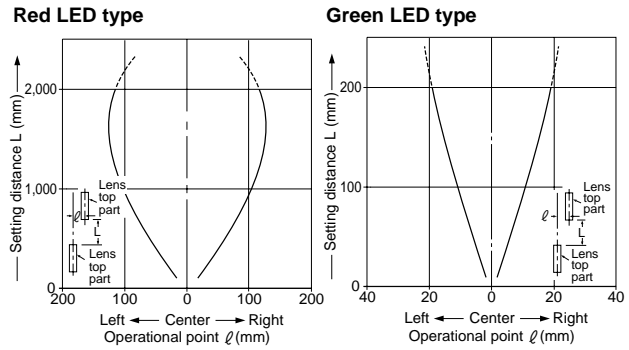

FT-R80 Thru-beam

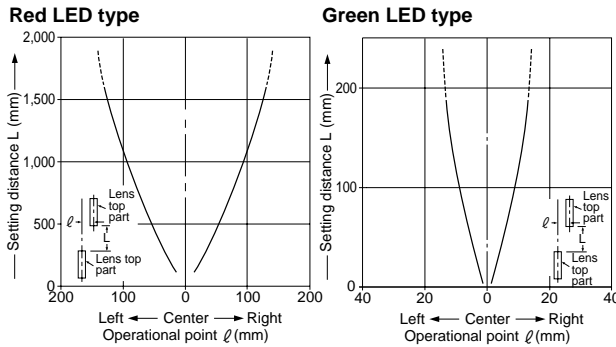

FT-H35-M2
FT-H20-M1 Thru-beam

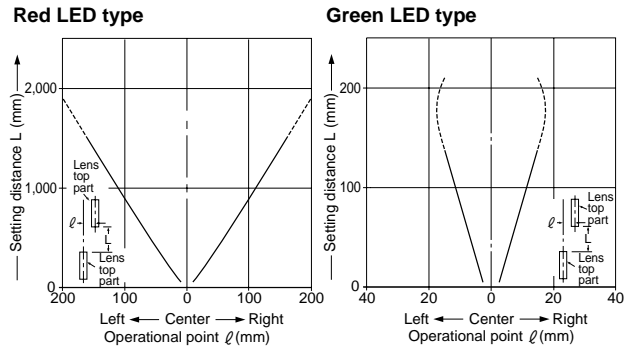

Parallel deviations with FX-LE2 (Super-expansion lens) applied on both sides

FT-B8 Thru-beam

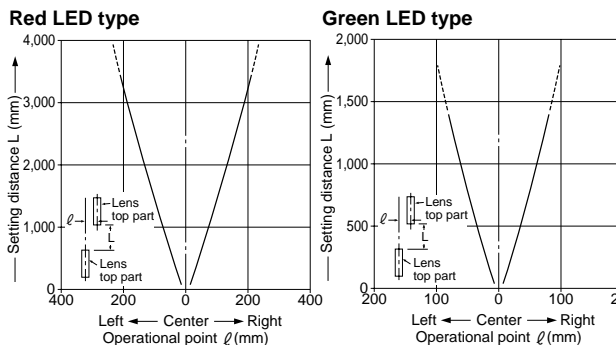

FT-FM2 Thru-beam

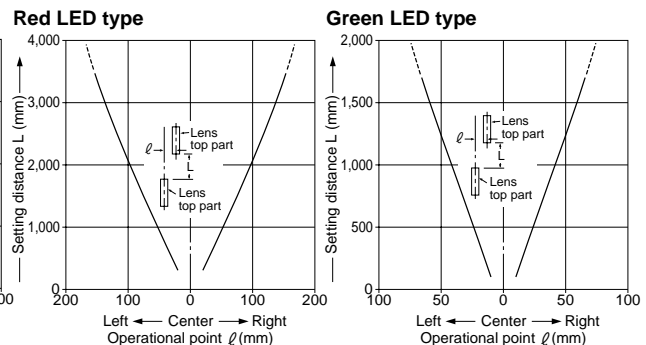

FZ-10

FX-7

FX-10

FX-11A

CX-20

CX-30

CX-ND300R

EX-10

EQ-20

EQ-30

EX-40

RX

RX-LS200

Fiber Sensor

Amplifier Built-in Type

SENSING FIELDS (TYPICAL)

Parallel deviations with FX-LE2 (Super-expansion lens) applied on both sides

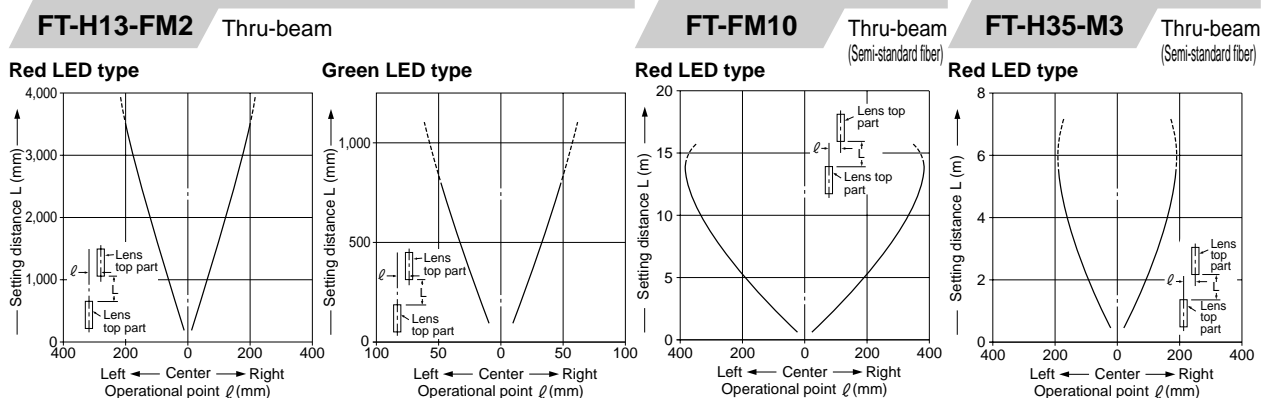
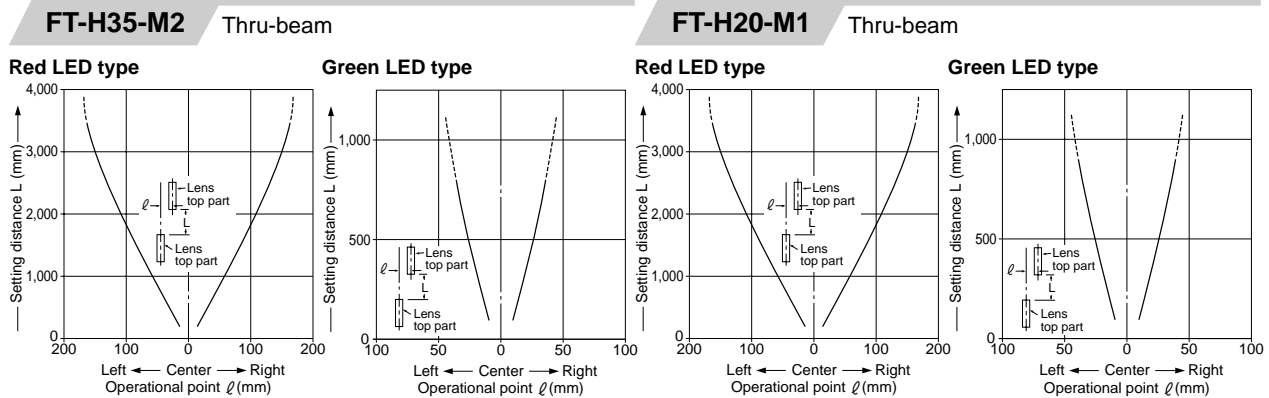
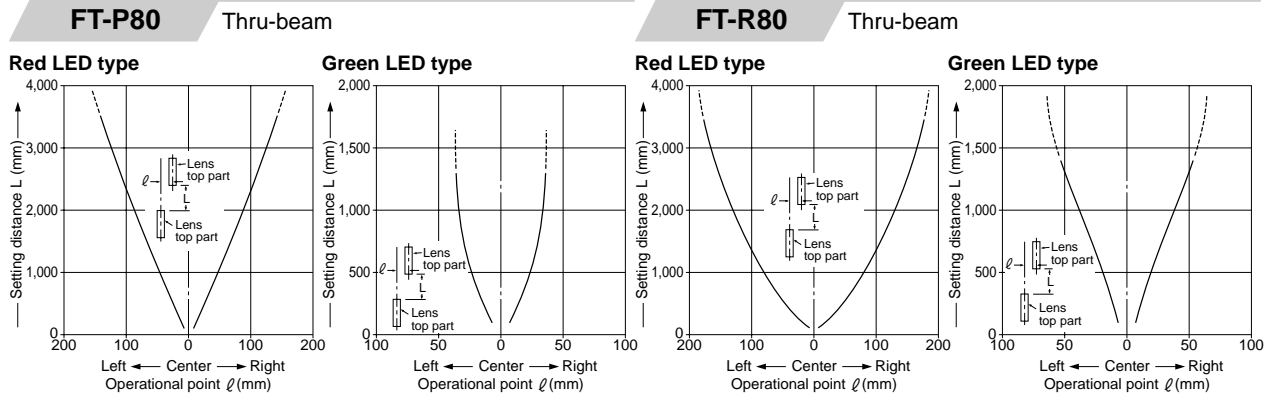

Parallel deviations with FV-LE1 (Vacuum-expansion lens) applied on both sides

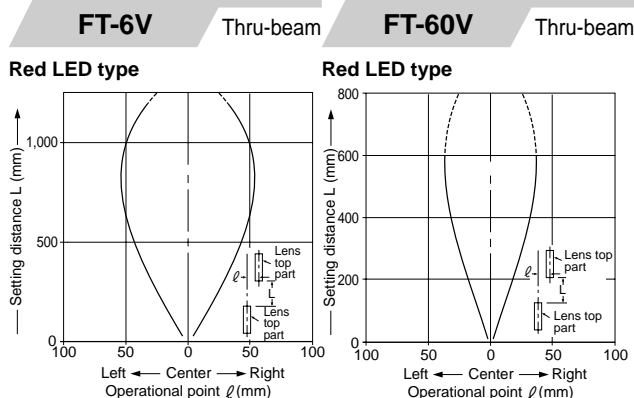

Fiber Sensor

- FX-7
- FX-10
- FX-11A
- CX-20
- CX-30
- CX-ND300R
- EX-10
- EX-20
- EQ-30
- EX-40
- RX
- RX-LS200

Amplifier Built-in Type

SENSING FIELDS (TYPICAL)

Parallel deviations with FX-SV1 (Side-view lens) applied on both sides

FT-B8 Thru-beam

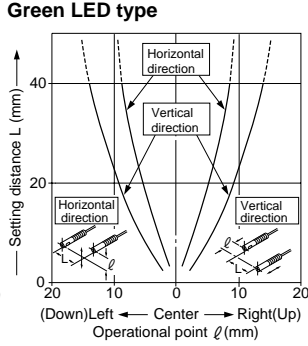
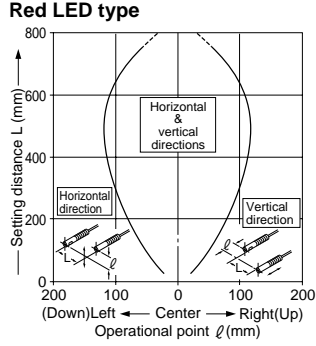

FT-FM2 FT-T80 Thru-beam

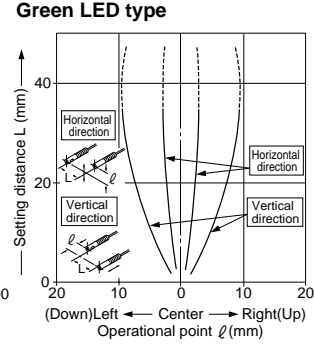
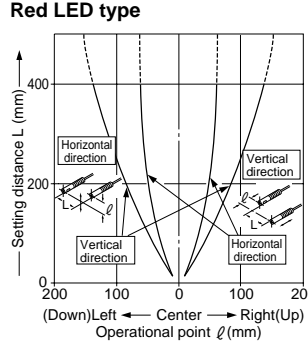

FT-C4 Thru-beam

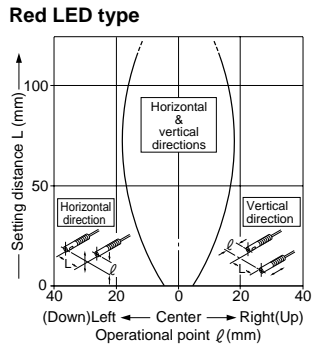

FT-P80 Thru-beam

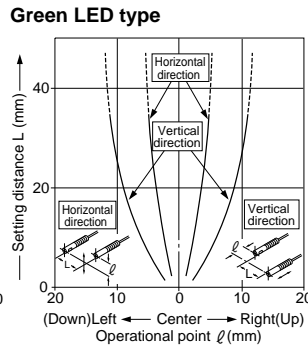
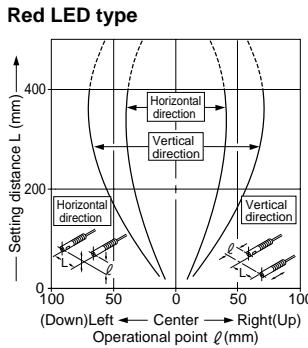

FT-H35-M2 FT-H20-M1 Thru-beam

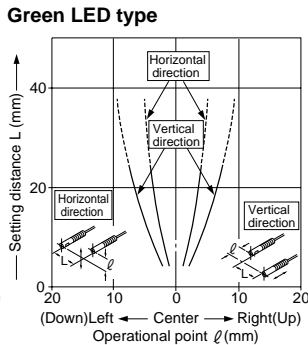
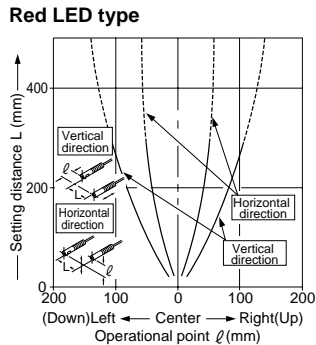

Sensing fields

FD-B8 Reflective

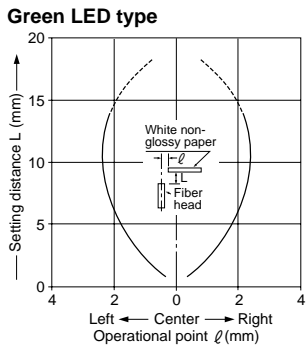
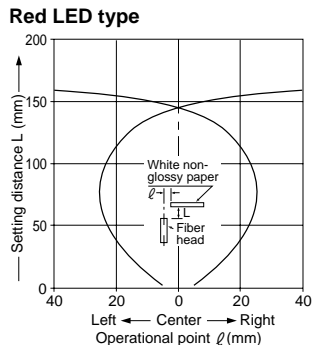

FD-5 FD-FM2 FD-FM2S FD-FM2S4 FD-T80 FD-S80 Reflective

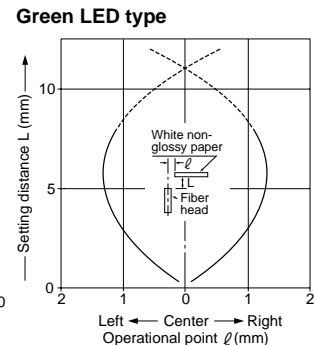
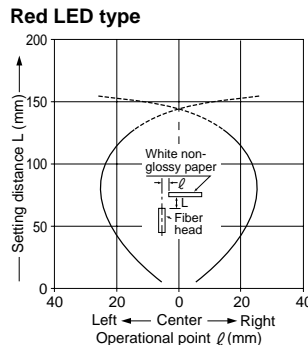

SENSING FIELDS (TYPICAL)

Sensing fields

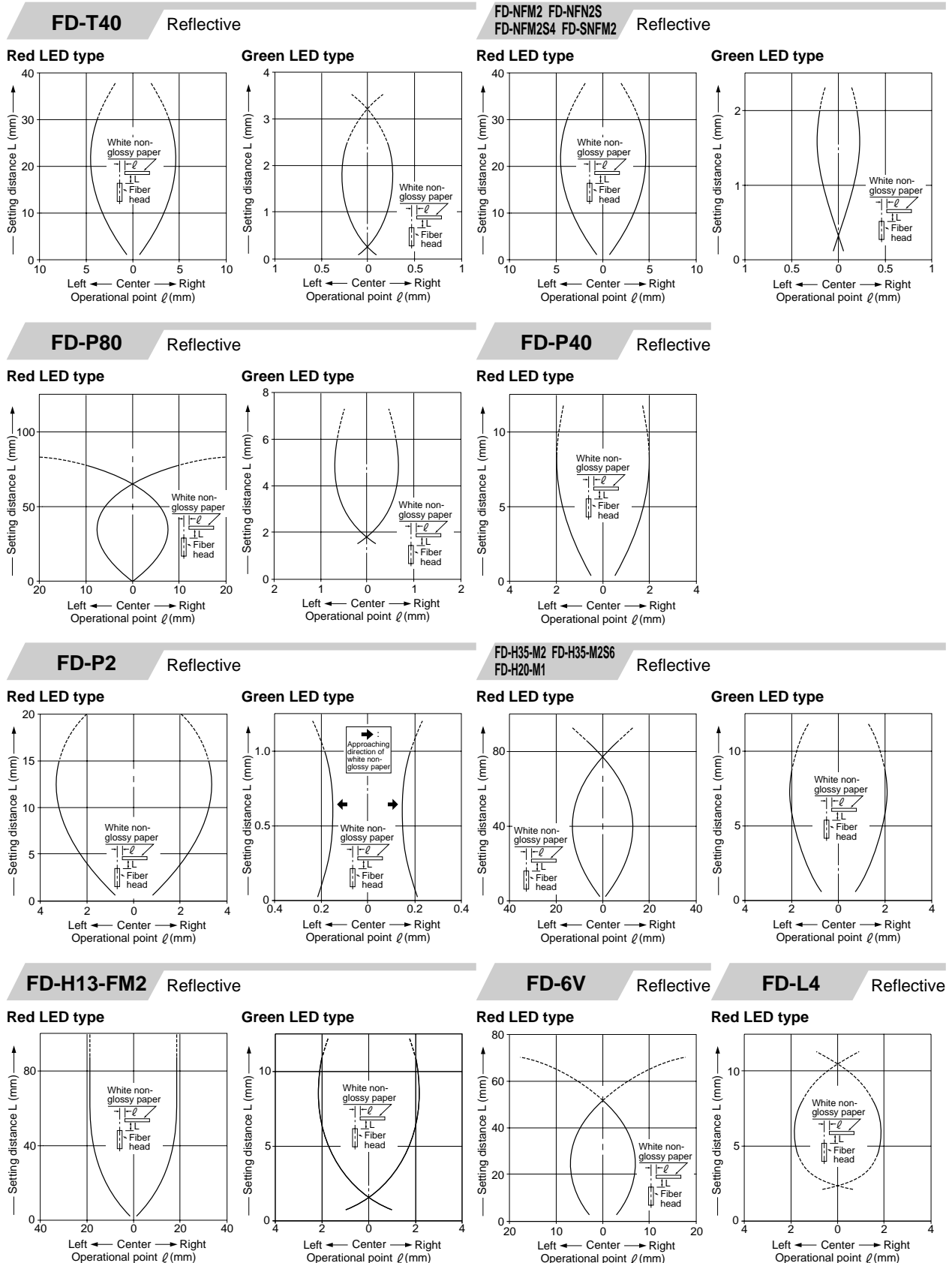

PHOTOELECTRIC SENSOR

Fiber Sensor
 FX-7
 FX-10
 FX-11A
 CX-20
 CX-30
 CX-ND300R
 CX-ND300R
 EX-10
 EX-20
 EQ-20
 EQ-30
 EX-40
 RX
 RX-LS200

FX-7

SENSING FIELDS (TYPICAL)

Sensing fields

FD-L41

Reflective

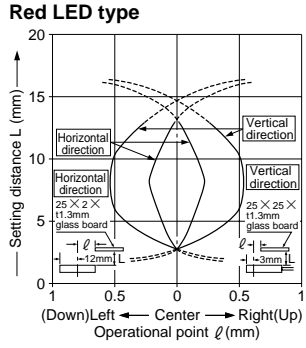

FD-L42

Reflective

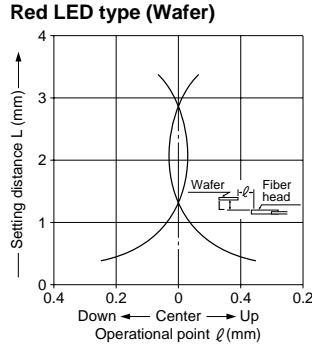

Red LED type (Glass board)

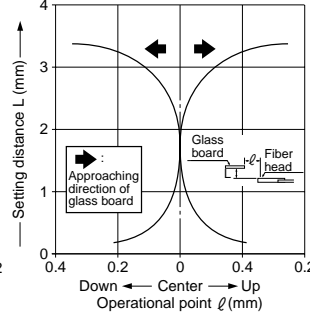

FD-G4

Reflective

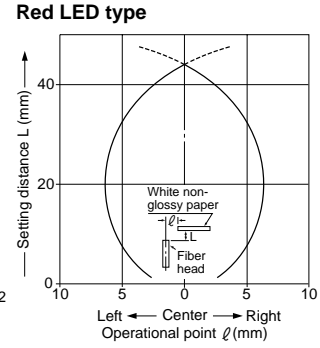

FD-G500

Reflective

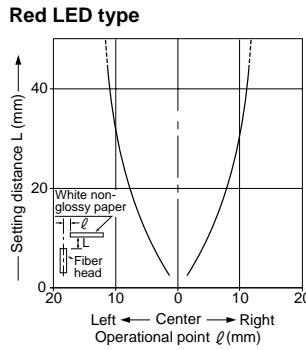

FD-EG1

Reflective

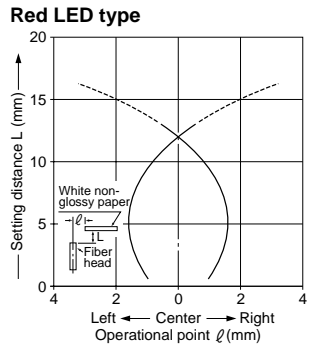

**FD-AFM2
FD-AFM2E**

Reflective

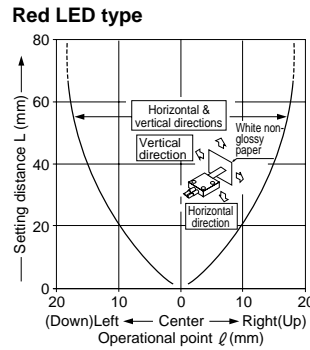

Green LED type

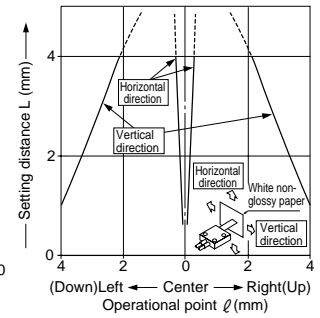

FD-R80

Reflective

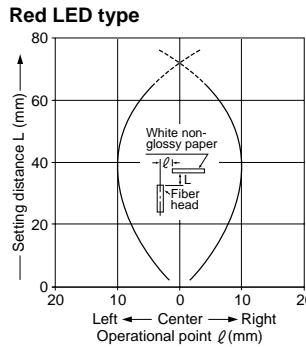

Green LED type

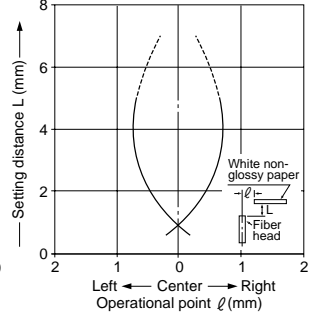

FD-V41

Reflective

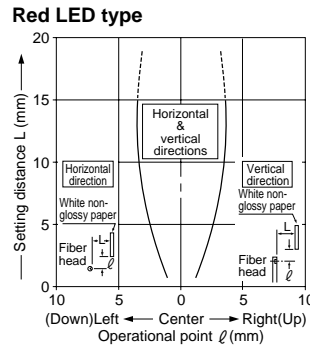

FD-SFM2SV2

Reflective

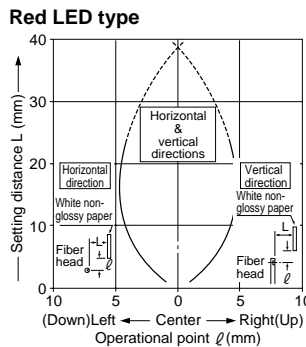

Green LED type

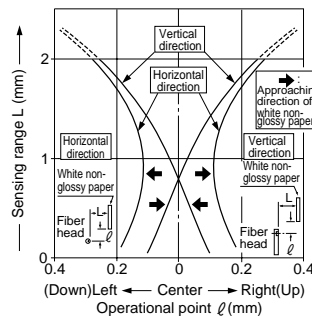

FD-EN500S1

Reflective

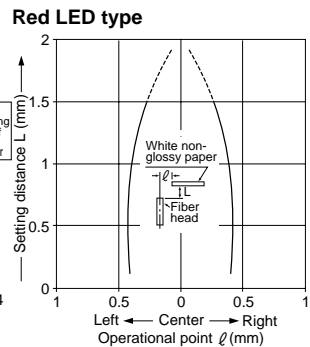

FD-ENM1S1

Reflective

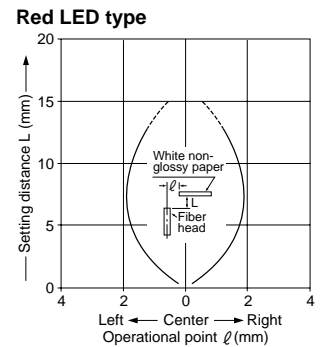

SENSING FIELDS (TYPICAL)

Sensing fields

FD-KM1S2 Reflective

Red LED type

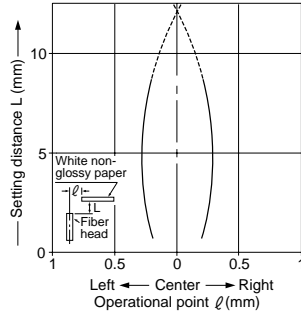

Sensing fields with FX-MR1 (Pinpoint spot lens) applied

FD-G4 Reflective **FD-G500** Reflective

Red LED type

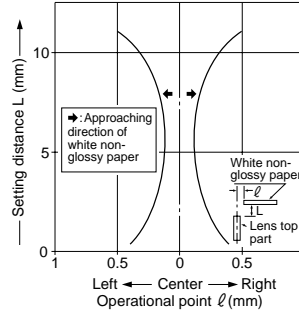

Red LED type

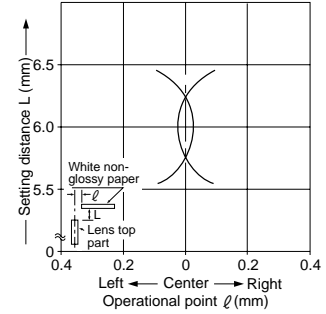

Sensing fields with FX-MR2 (Zoom lens) applied

FD-G4 Reflective

Red LED type

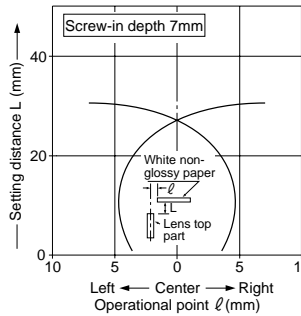

Red LED type

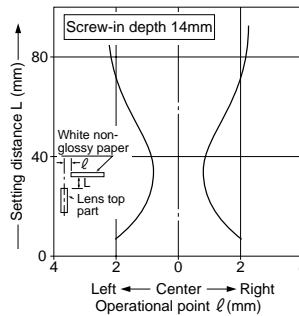

FD-G500 Reflective

Red LED type

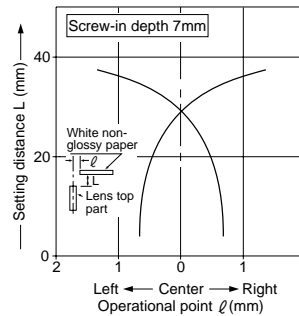

Red LED type

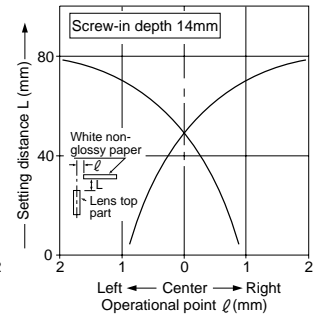

Sensing fields with FX-MR3 (Finest spot lens) applied

FD-G4 Reflective

Red LED type

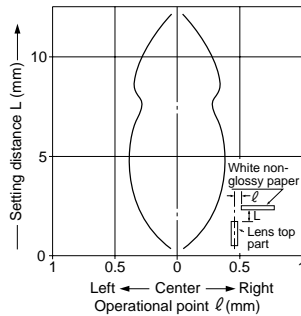

FD-EG1 Reflective

Red LED type

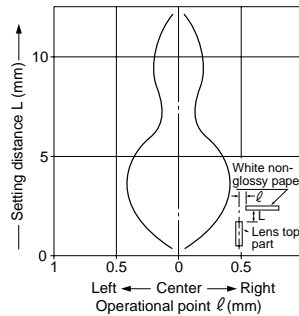

FZ-10

Fiber Sensor
FX-7

FX-10

FX-11A

CX-20

CX-30

CX-ND300R

Amplifier Built-in Type
EX-10

EQ-20

EQ-30

EX-40

RX

RX-LS200

SENSING FIELDS (TYPICAL)

Sensing fields with FX-MR5 (Side-view type zoom lens) applied

**FD-G4
FD-G500** Reflective

Red LED type

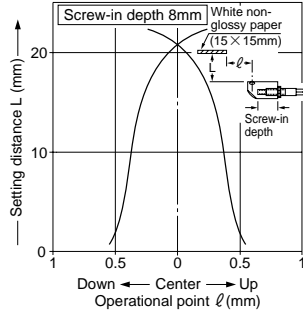

Red LED type

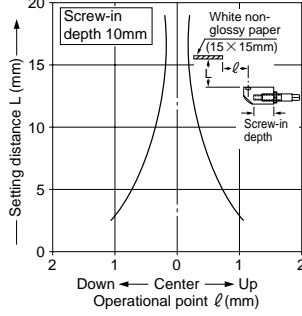

Red LED type

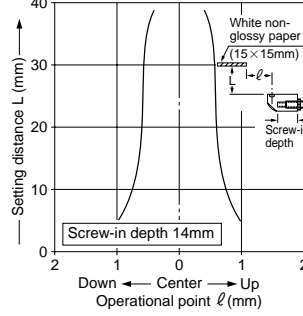

Correlation between diameter of an object and sensing field (Red LED type)

FD-B8 Reflective

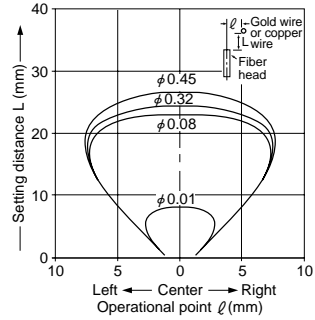

**FD-5 FD-FM2
FD-T80 FD-S80** Reflective

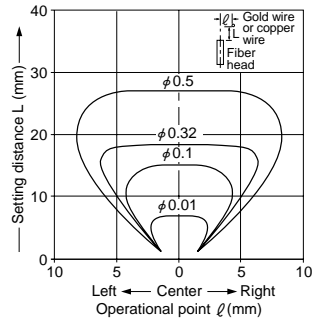

FD-T40 Reflective

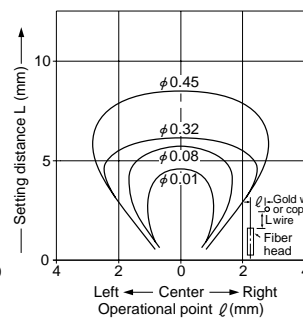

FD-NFM2 Reflective

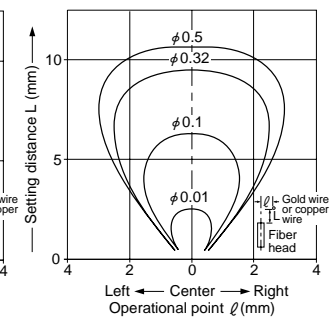

FD-P80 Reflective

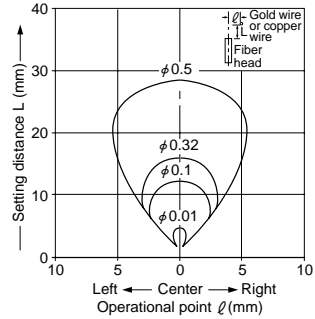

FD-P40 Reflective

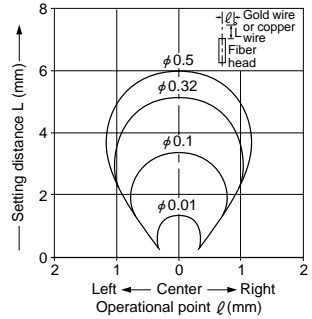

FD-P2 Reflective

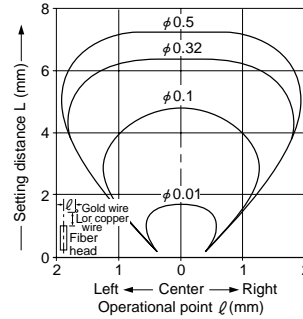

FD-L4 Reflective

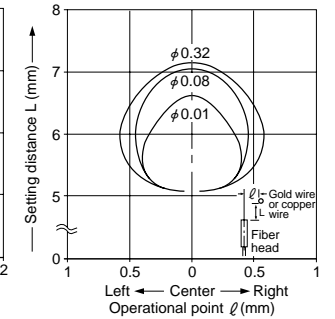

**FD-G4
FD-G500** Reflective

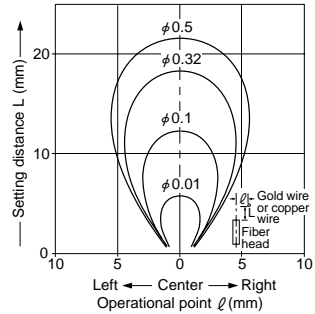

FD-EG1 Reflective

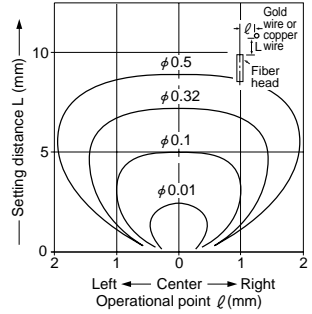

FD-AFM2 Reflective

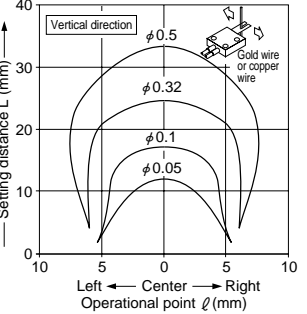
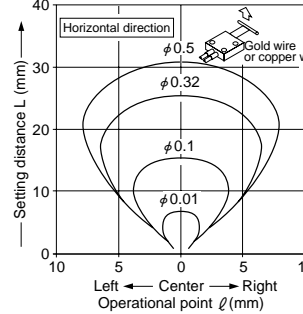

SENSING FIELDS (TYPICAL)

Correlation between diameter of an object and sensing field (Red LED type)

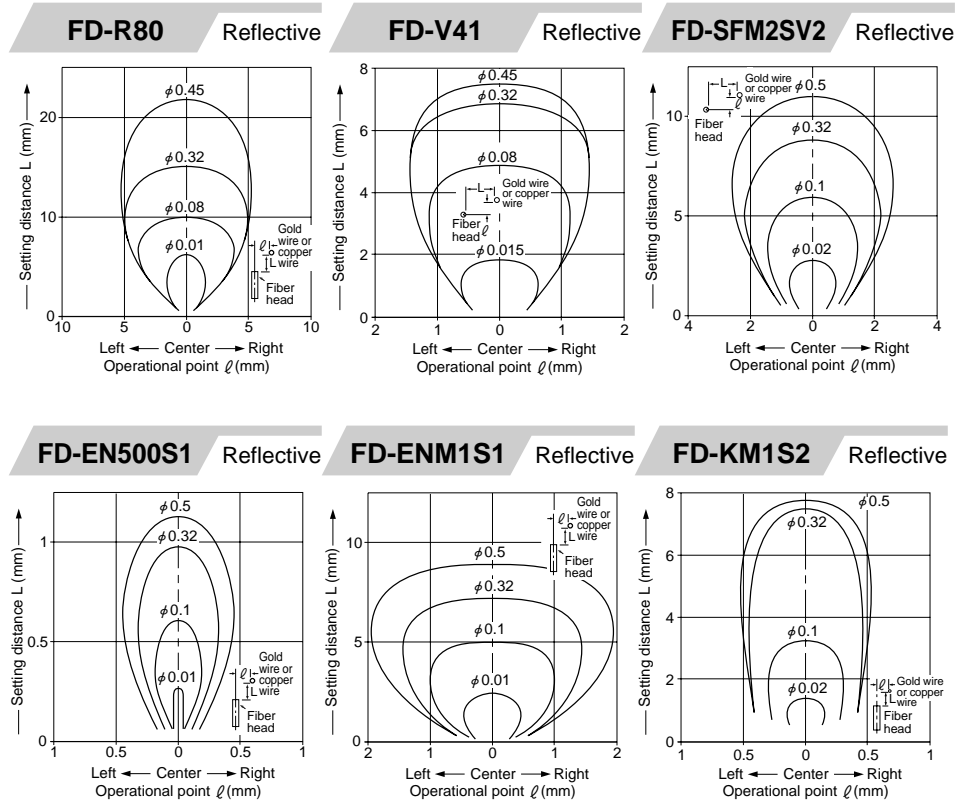

Crosstalk characteristics (Red LED type)

The following graphs are specified that two sensors are set at the same emitting frequency. If they are set at the distinct frequencies, they can be mounted close together.

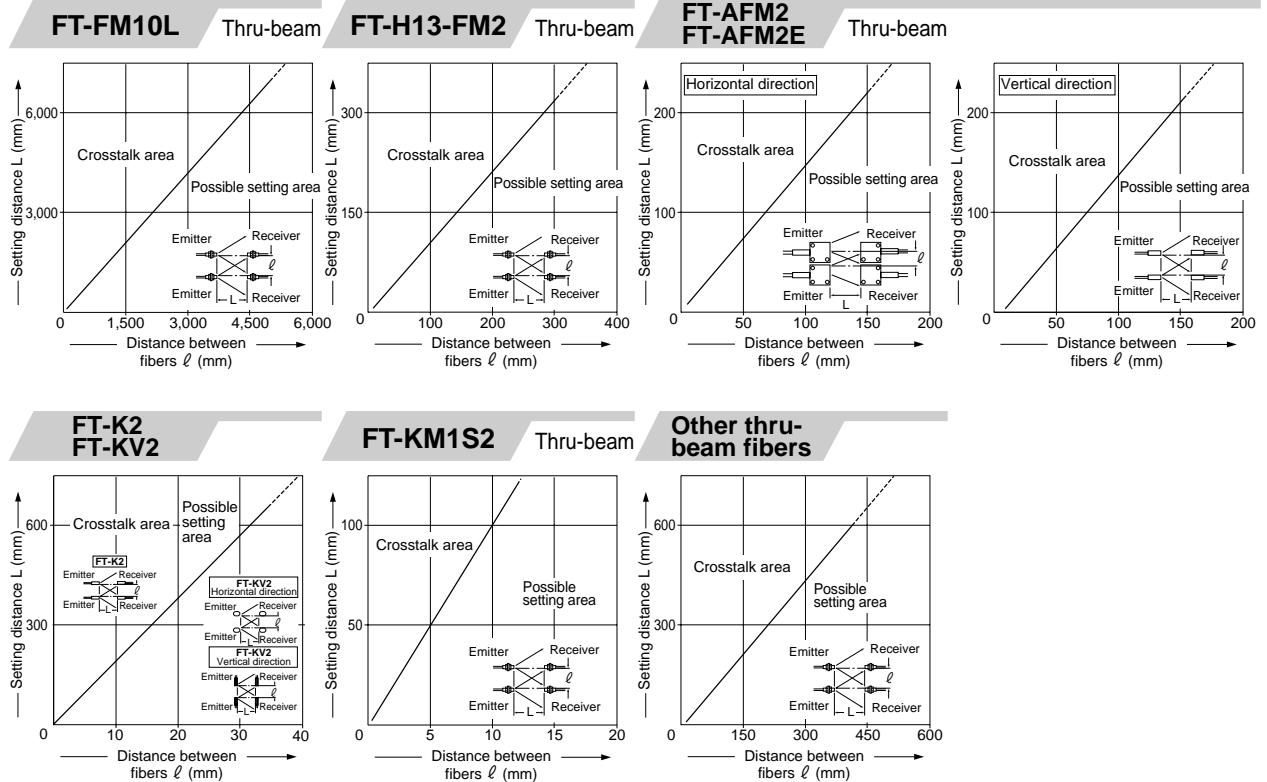

FX-7

SENSING FIELDS (TYPICAL)

Crosstalk characteristics (Red LED type)

- The following graphs are specified that two sensors are set at the same emitting frequency. If they are set at the distinct frequencies, they can be mounted close together.

FD-H13-FM2

Reflective

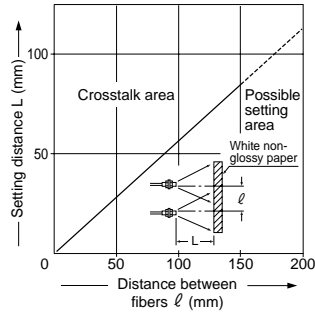

FD-L4

Reflective

Horizontal direction

The fibers can be mounted closely.

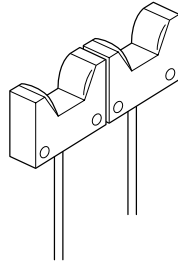

Vertical direction

Keep the distance of 15mm or more.

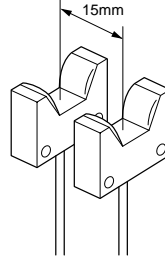

FD-L41 FD-L42 FD-KM1S2

Reflective

These fibers can be mounted closely.

FD-AFM2 FD-AFM2E

Reflective

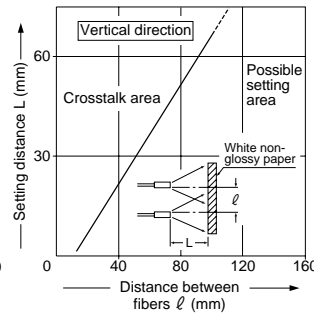
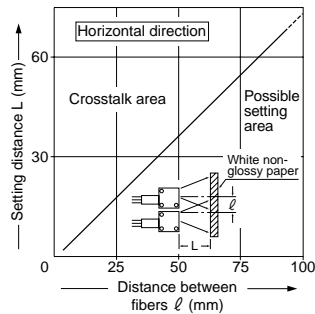

Other reflective fibers

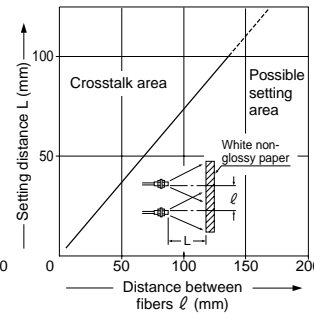

PRECAUTIONS FOR PROPER USE

Refer to P.682~ for general cautions

Amplifier



This product is not a safety sensor. Its use is not intended or designed to protect life and prevent body injury or property damage from dangerous parts of machinery. It is a normal object detection sensor.

Mounting

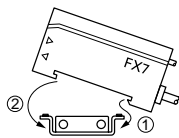

- Hook the rear part to the attached mounting bracket (**MS-DIN-2**) or DIN rail.
- Press the amplifier down on the bracket or DIN rail.

DIN rail or the attached mounting bracket

- ※ To remove the amplifier, push it forward and lift up the front side.

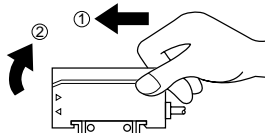

How to connect fiber cables

- The set of fiber cables is connected at a touch.

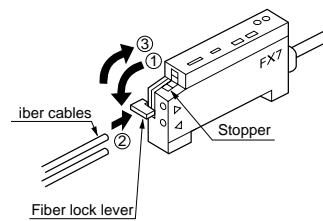

- Snap the fiber lock lever down.
- Insert both fiber cables into the inlets slowly until fully deepend.
- Snap the fiber lock lever up until a "click" is heard.

Designation

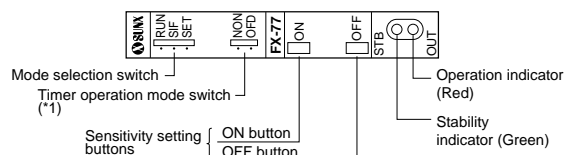

(*1): The external synchronization selection switch is substituted for it on **FX-77** or **FX-77G**.