

LA-300 SERIES

LED Collimated Beam Sensor

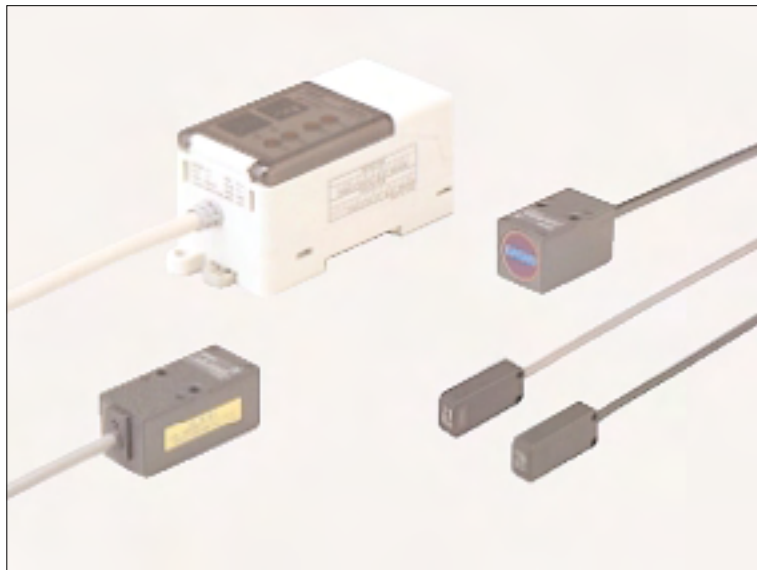

LED collimated beam type which is as accurate as a laser sensor, but much safer.



Conforming to
EMC Directive

Compact size

Its emitter and receiver are much smaller compared to those of the amplifier built-in type (LA-510). Hence, they can be installed even in a narrow space inside an automatic assembly machine, etc.

Long sensing range type / LA-310



- Emitter:
W20 × H20 × D45 mm
W0.787 × H0.787 × D1.772 in
- Receiver:
W20 × H20 × D35 mm
W0.787 × H0.787 × D1.378 in

Slim type / LA-305



- Emitter:
W18 × H40 × D10 mm
W0.709 × H1.575 × D0.394 in
- Receiver:
W18 × H40 × D10 mm
W0.709 × H1.575 × D0.394 in

Two comparative outputs plus one analog output

In addition to 1 to 5 V analog output, two comparative outputs (HIGH, LOW) have been incorporated.

External synchronization

The timing and the effective duration of the comparative outputs can be controlled by an external input. (Either edge trigger or gate trigger is selectable.)

Safe red LED beam

Since a red LED, harmless to your eyes, has been incorporated as the beam source, you are free from strict laser safety regulations. Moreover, due to the red LED beam source, the measuring spot is visible, which makes positioning of the object simple.

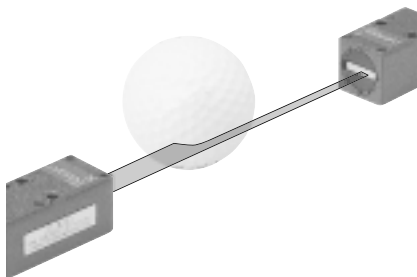

Simple beam alignment

Beam alignment is easy by using the target label (accessory). Further, the 3-stage stability indicators on the amplifier indicate the incident beam level at a glance.

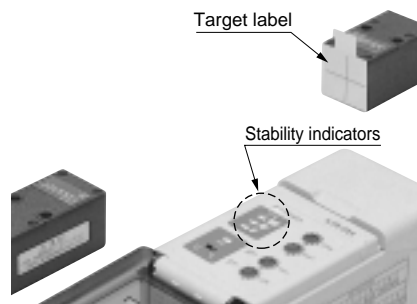

Span & shift adjustment

For the analog output, in addition to the span adjustment function, a convenient shift function which enables the analog voltage to be shifted by ± 0.5 V has been incorporated.

Example: To shift the analog voltage from 2.51 V to 3.00 V with a certain amount of beam interruption

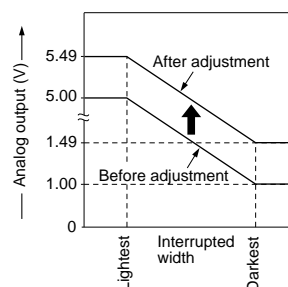
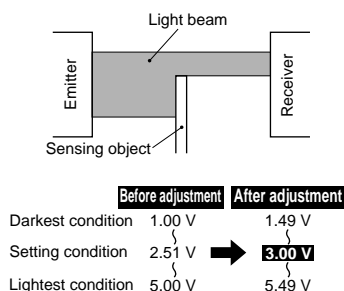

APPLICATIONS

Detecting unseated wafers

Two sensors inspect vertical and lateral displacement of wafers.

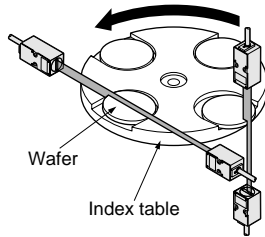

Inspecting burrs on workpieces

If burrs are present, they increase the width of beam interruption.

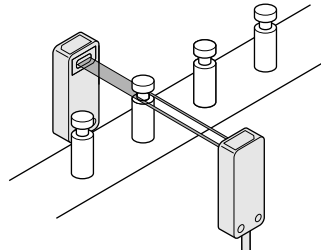

Detecting glass bottles

Even clear glass bottles are reliably detected.

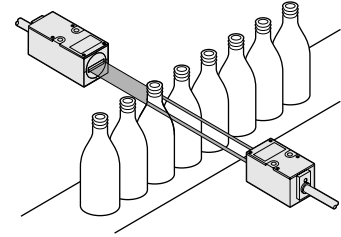

ORDER GUIDE

Sensor heads Always use the sensor head and the amplifier together as a set.

Type	Appearance	Sensing range	Sensing width	Minimum sensing object	Model No.
Long sensing range		500 mm 19.685 in	10 mm 0.394 in	φ0.1 mm φ0.004 in opaque object	LA-310
Slim		300 mm 11.811 in	5 mm 0.197 in	φ0.05 mm φ0.002 in opaque object	LA-305

Amplifiers Always use the sensor head and the amplifier together as a set.

Type	Appearance	Model No.	Output
NPN output		LA-A1	NPN open-collector transistor (Comparative outputs) Analog voltage • Output voltage 1 to 5 V
PNP output		LA-A1P	PNP open-collector transistor (Comparative outputs) Analog voltage • Output voltage 1 to 5 V

Accessories

• MS-LA3-1
(Sensor head mounting bracket for LA-310)

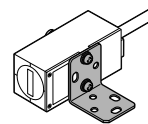

Four M3 (length 25 mm 0.984 in) pan head screws are attached.

• MS-LA3-2
(Sensor head mounting bracket for LA-305)

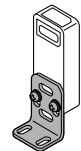

Four M3 (length 15 mm 0.591 in) screws with washers are attached.

OPTIONS

Designation	Model No.	Description
Digital panel controller (Note)	CA2-T2	NPN open-collector transistor This is a very small controller which allows two independent threshold level settings. • Supply voltage: 24 V DC ± 10 % • No. of inputs: 1 No. (sensor input) • Input range: 1 to 5 V DC • Main functions: Auto-reference function, zero-adjust function, start / hold function, etc.
	CA-R2	Relay contact This is a multi-functional controller having mathematical functions, hold function, etc. • Supply voltage: 100 to 240 V AC ± 10 % • No. of inputs: 2 Nos. (sensor inputs) • Input range: 1 to 5 V DC • Power supply for sensor: 12 V DC, 150 mA
	CA-T2	NPN open-collector transistor • Main functions: Mathematical functions, hold function, auto-reference function, zero-adjust function, etc.
	CA-B2	NPN open-collector transistor With BCD output

Digital panel controller

• CA2 series



• CA series



Note: If analog voltage output of LA-A1 or LA-A1P is shifted, the input range may be exceeded. In that case, use CA2-T5 or CA-□5 (input range -10 to +10 V). For further details, refer to p.864~ for the ultra-compact digital panel controller CA2 series, and to p.854~ for the digital panel controller CA series.

LA-300

SPECIFICATIONS

Sensor heads

Type	Long sensing range	Slim	
Item Model No.	LA-310	LA-305	
Applicable amplifiers	LA-A1, LA-A1P		
Beam width	10 mm 0.394 in	5 mm 0.197 in	
Sensing range	500 mm 19.685 in	300 mm 11.811 in	
Min. sensing object	φ0.1 mm φ0.004 in opaque object	φ0.05 mm φ0.002 in opaque object	
Repeatability	0.01 mm 0.0004 in or less (perpendicular to sensing axis)		
Temperature characteristics	0.1 % F.S. /°C or less	0.2 % F.S. /°C or less	
Emission indicator	Red LED (lights up when emitting)		
Environmental resistance	Pollution degree	3 (Industrial environment)	
	Ambient temperature	0 to +40 °C +32 to +104 °F (No dew condensation), Storage: -20 to +70°C -4 to +158 °F	
	Ambient humidity	35 to 85 % RH, Storage: 35 to 85 % RH	
	Ambient illuminance	Sunlight: 10,000 lx at the light-receiving face, Incandescent light: 10,000 lx at the light-receiving face	
	EMC	EN 50081-2, EN 50082-2, EN 61000-6-2	
	Voltage withstandability	1,000 V AC for one min. between all supply terminals connected together and enclosure	
	Insulation resistance	20 MΩ, or more, with 250 V DC megger between all supply terminals connected together and enclosure	
	Vibration resistance	10 to 150 Hz frequency, 0.75 mm 0.030 in amplitude in X, Y and Z directions for two hours each	
	Shock resistance	500 m/s ² acceleration (50 G approx.) in X, Y and Z directions for three times each	
Emitting element	Red LED (modulated)		
Material	Enclosure: Die-cast zinc alloy Top face: Aluminum	Enclosure: Heat-resistant ABS Cover: Heat-resistant ABS, Front cover: Glass	
Cable	0.22 mm ² 3-core composite cable, 2 m 6.562 ft long	0.18 mm ² 3-core composite cable, 2 m 6.562 ft long	
Cable extension	Extension up to total 10 m 32.808 ft is possible, for both emitter and receiver, with 0.22 mm ² , or more, cable. (Shield wire must be extended with shield wire.)	Extension up to total 10 m 32.808 ft is possible, for both emitter and receiver, with 0.18 mm ² , or more, cable. (Shield wire must be extended with shield wire.)	
Weight	Emitter: 110 g approx., Receiver: 100 g approx.	Emitter: 70 g approx., Receiver: 70 g approx.	
Accessories	MS-LA3-1 (Sensor head mounting bracket): 1 set for emitter and receiver, Target label: 2 pcs.	MS-LA3-2 (Sensor head mounting bracket): 1 set for emitter and receiver, Target label: 2 pcs.	

SPECIFICATIONS

Amplifiers

		Type	NPN output type	PNP output type
Item	Model No.		LA-A1	LA-A1P
Applicable sensor heads		LA-310, LA-305		
Supply voltage		12 to 24 V DC \pm 10 % Ripple P-P 10 % or less		
Current consumption		120 mA or less (including sensor heads)		
Comparative outputs (HIGH, LOW)		NPN open-collector transistor • Maximum sink current: 100 mA • Applied voltage: 30 V DC or less (between comparative output and 0 V) • Residual voltage: 1.5 V or less (at 100 mA sink current) 0.5 V or less (at 16 mA sink current)		PNP open-collector transistor • Maximum source current: 100 mA • Applied voltage: 30 V DC or less (between comparative output and +V) • Residual voltage: 1.5 V or less (at 100 mA source current) 0.5 V or less (at 16 mA source current)
Utilization category		DC-12 or DC-13		
Response time		0.5 ms or less		
Output operation		HIGH output: ON when the received beam level is equal to or lower than HIGH (Over-dark) level LOW output: ON when the received beam level is equal to or higher than LOW (Under-dark) level		
Short-circuit protection		Incorporated		
Analog output		Analog voltage • Output voltage: 1 V (Darkest) to 5 V (Lightest) • Output impedance: 75 Ω		
Slew rate		8 V/ms or more		
Temperature characteristics		0.05 % F.S. /°C or less		
External synchronization		Incorporated (Active-Low, either gate trigger or edge trigger is selectable)		
Indicators	Power	Green LED (lights up when the power is ON)		
	Stable incident beam	Three green LEDs (light up in three stages in proportion to the amount of beam received)		
	Operation	Two orange LEDs (light up when High and Low comparative outputs are ON, respectively)		
	External synchronization	Green LED (lights up when the external synchronization input is effective, i.e., LOW)		
Adjusters	Span	15-turn adjuster sets the span for the analog output voltage		
	Shift	15-turn adjuster sets the offset for the analog output voltage		
	HIGH (Over-dark) level	15-turn adjuster sets the HIGH output threshold level (Over-dark level)		
	LOW (Under-dark) level	15-turn adjuster sets the LOW output threshold level (Under-dark level)		
Environmental resistance	Pollution degree	3 (Industrial environment)		
	Ambient temperature	0 to + 50 °C + 32 to + 122 °F (No dew condensation), Storage: - 20 to + 70°C - 4 to + 158 °F		
	Ambient humidity	35 to 85 % RH, Storage: 35 to 85 % RH		
	EMC	EN 50081-2, EN 50082-2, EN 61000-6-2		
	Voltage withstandability	1,000 V AC for one min. between all supply terminals connected together and enclosure		
	Insulation resistance	20 M Ω , or more, with 250 V DC megger between all supply terminals connected together and enclosure		
	Vibration resistance	10 to 150 Hz frequency, 0.75 mm 0.030 in amplitude in X, Y and Z directions for two hours each		
Shock resistance	500 m/s ² acceleration (50 G approx.) in X, Y and Z directions for three times each			
Material		Enclosure: Heat-resistant ABS, Terminal cover: Heat-resistant ABS, Front cover: Polycarbonate		
Cable		0.22 mm ² (shield wire: 0.15 mm ²) 7-core composite cabtyre cable, 2 m 6.562 ft long		
Cable extension		Extension up to total 50 m 164.042 ft is possible with 0.22 mm ² , or more, cable. (Shield wire must be extended with 0.15 mm ² , or more, shield wire.)		
Weight		200 g approx.		
Accessory		Adjusting screwdriver: 1 pc.		

Note: This is a CE conformity product complying with EMC Directive. The harmonized standard with regard to immunity that applies to this product is EN 61000-6-2 and the following conditions must be met to conform to that standard.

Conditions

- The amplifier should be connected less than 10 m 32.808 ft from the power supply.
 - The signal line to connect with the amplifier should be less than 30 m 98.425 ft.
- The EN 50082-2 that previously applied to the products for conforming to EMC Directive was replaced by EN 61000-6-2 starting April 1st, 2002.

I/O CIRCUIT AND WIRING DIAGRAMS

LA-A1 NPN output type

I/O circuit diagram

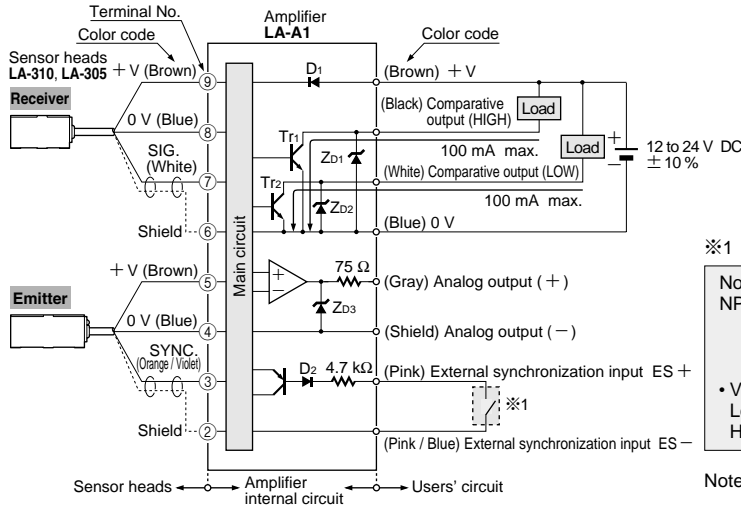

Symbols ... D1: Reverse supply polarity protection diode
 D2: Input protection diode
 ZD1, ZD2, ZD3: Surge absorption zener diode
 Tr1, Tr2: NPN output transistor

※1

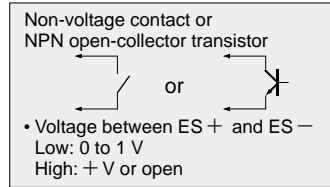

- Notes: 1) When ES+ (pink) and ES- (pink/blue) of external synchronization input are connected, both HIGH and LOW comparative outputs are triggered in the mode selected by the external synchronization selection switch. If the external synchronization function is not used, short-circuit ES+ and ES- and set the external synchronization selection switch to gate trigger.
- 2) To use the analog output (gray), choose a device with an input impedance of 1 MΩ, or more, and connect the shield wire of the analog output to 0 V (common input) of the device.
- 3) Insulate all unused wires individually to avoid miscontact.

LA-A1P PNP output type

I/O circuit diagram

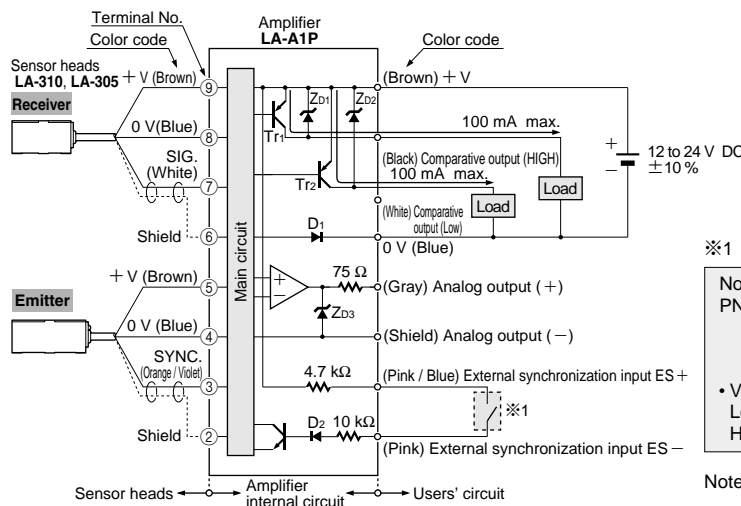

Symbols ... D1: Reverse supply polarity protection diode
 D2: Input protection diode
 ZD1, ZD2, ZD3: Surge absorption zener diode
 Tr1, Tr2: PNP output transistor

※1

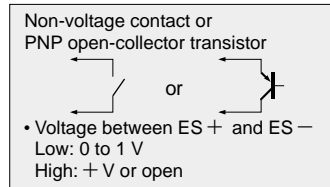

- Notes: 1) When ES+ (pink/blue) and ES- (pink) of external synchronization input are connected, both HIGH and LOW comparative outputs are triggered in the mode selected by the external synchronization selection switch. If the external synchronization function is not used, short-circuit ES+ and ES- and set the external synchronization selection switch to gate trigger.
- 2) To use the analog output (gray), choose a device with an input impedance of 1 MΩ, or more, and connect the shield wire of the analog output to 0 V (common input) of the device.
- 3) Insulate all unused wires individually to avoid miscontact.

I/O CIRCUIT AND WIRING DIAGRAMS

Wiring diagram

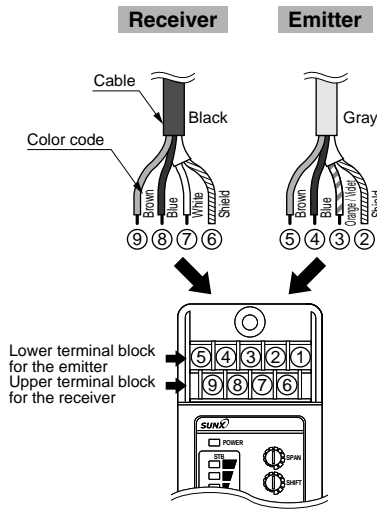

Connect color-coded wires in accordance with the table below. The receiver wires should be connected on the upper terminal block and the emitter wires on the lower terminal block.

Emitter		Receiver	
Terminal No.	Color code	Terminal No.	Color code
②	Shield	⑥	Shield
③	Orange / Violet	⑦	White
④	Blue	⑧	Blue
⑤	Brown	⑨	Brown

Note: Do not connect any wire to the terminal ①.

SENSING CHARACTERISTICS (TYPICAL)

LA-310

Long sensing range type

Correlation between transverse deviation and output voltage

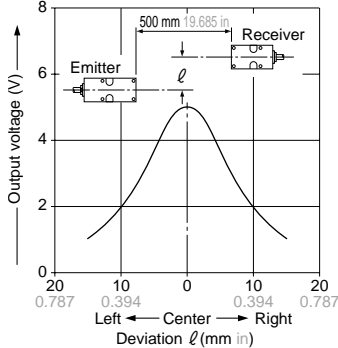

Correlation between interrupted beam width and output voltage

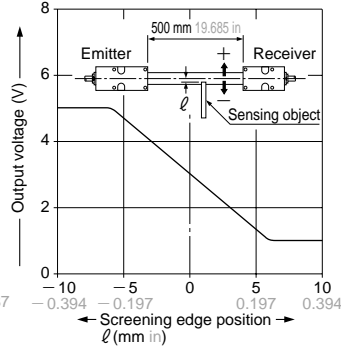

Correlation between ambient temperature and output voltage variation rate

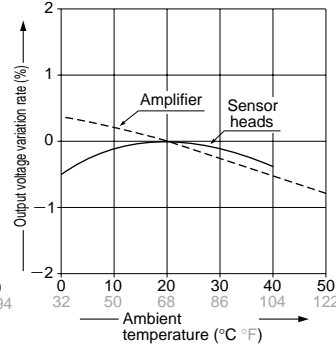

LA-305

Slim type

Correlation between transverse deviation and output voltage

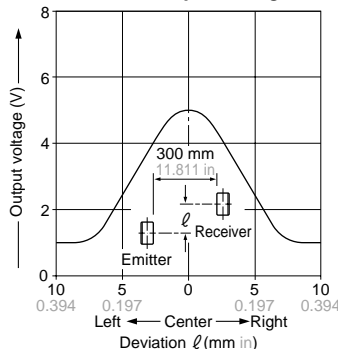

Correlation between interrupted beam width and output voltage

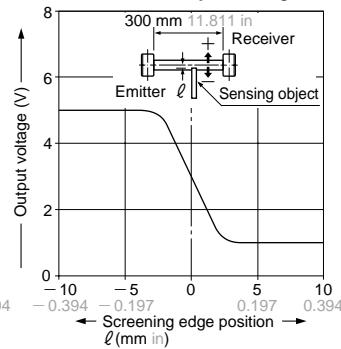

Correlation between ambient temperature and output voltage variation rate

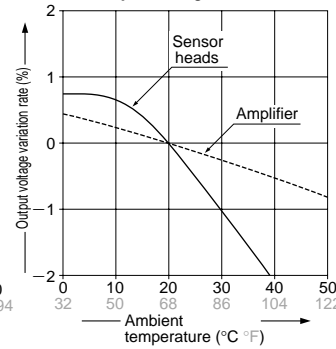

LA-300

PRECAUTIONS FOR PROPER USE



This product is not a safety sensor. Its use is not intended or designed to protect life and prevent body injury or property damage from dangerous parts of machinery. It is a normal object detection sensor.

Mounting

Sensor heads

- The projected LED beam has a directionality. Hence, take care of emitter and receiver mounting direction.

LA-310

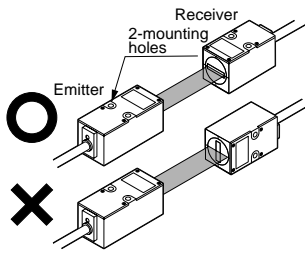

LA-305

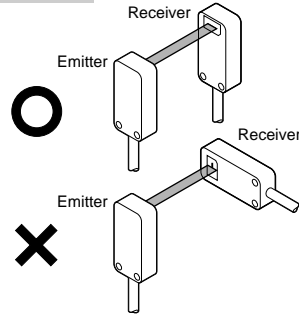

- The tightening torque should be 0.5 N·m or less.

LA-310

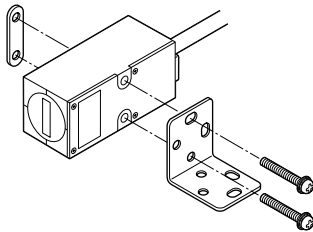

Sensor head mounting bracket MS-LA3-1 (Accessory)

LA-305

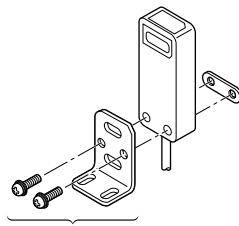

Sensor head mounting bracket MS-LA3-2 (Accessory) (Note)

Note: When carrying out high accuracy sensing with LA-305, install the mounting bracket on the front face as shown in the above figure.

Amplifier

<Mounting on DIN rail>

- Make sure that the mounting stopper is latched inside. Hook the front side of the controller mounting section on the 35 mm 1.378 in width DIN rail.
- Snap the controller down on the 35 mm 1.378 in width DIN rail.

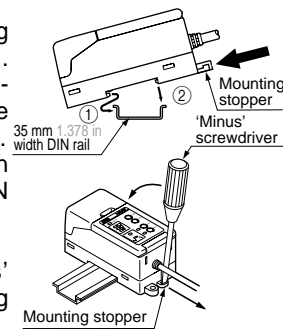

※ To remove, insert a 'minus' screwdriver into the mounting stopper and pull out.

<Mounting with screws>

- Use two commercially available M4 screws. The tightening torque should be 1.2 N·m or less.

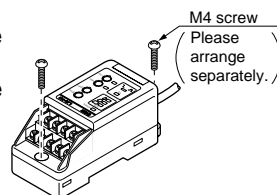

Beam alignment

- Make sure that at least one stability indicator lights up when you supply power to the amplifier connected with sensor heads. While aligning sensor heads, if more stability indicators light up, more reliable detection can be obtained.
- Beam alignment should be performed prior to any adjustments on the amplifier.
- If the bottom face and the side face of the emitter and the receiver are mounted on the same plane surfaces, or if the front faces of the emitter and the receiver of LA-305 are kept parallel and their top face and side face are mounted on the same plane surfaces, beam alignment need not be done.
- If mounting is not possible on the same plane surfaces, affix the target label (accessory) on the front surface of the receiver and adjust so that the emitted beam is incident at the center of the crosshair. After the alignment, peel off the target label.
- If either sensor head moves out of position, do the beam alignment and then the amplifier adjustment also again.

LA-310

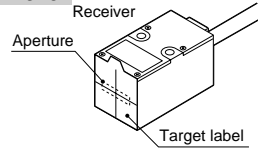

LA-305

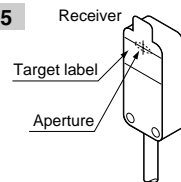

- To obtain optimum beam alignment, use a voltmeter and adjust the position to obtain the peak analog output signal from the amplifier.

Functional description

Amplifier

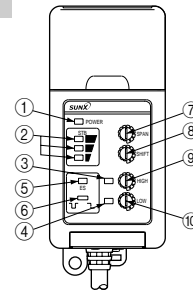

Sensor head / LA-310 (Emitter)

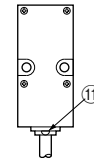

	Description	Function
①	Power indicator (Green LED)	Lights up when the power is on.
②	Stable incident beam indicators (Green LED × 3)	Light up in three stages proportional to the amount of beam received.
③	HIGH operation indicator (Orange LED)	Lights up when HIGH output is ON.
④	LOW operation indicator (Orange LED)	Lights up when LOW output is ON.
⑤	External synchronization indicator (Green LED)	Lights up while the external synchronization input is LOW. (Active-LOW)
⑥	External synchronization selection switch	Selects between gate trigger '┐' and edge trigger '┌'.
⑦	Span adjuster	15-turn adjuster sets the span for the analog output voltage.
⑧	Shift adjuster	15-turn adjuster sets the offset for the analog output voltage. It calibrates the output voltage at zero input.
⑨	HIGH level adjuster	15-turn adjuster sets the HIGH output threshold level (Over-dark level).
⑩	LOW level adjuster	15-turn adjuster sets the LOW output threshold level (Under-dark level).
⑪	Emitting indicator (Red LED)	Lights up during emission.

PRECAUTIONS FOR PROPER USE

Calibrating analog output

- The analog voltage output relates to the span and the shift adjustments as in the figure below.

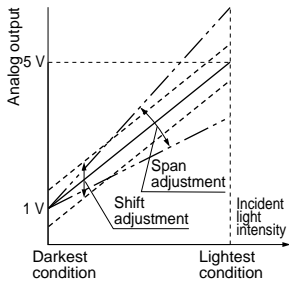

How to calibrate the output into 1 to 5 V

- Block the whole beam to enter into the darkest condition and set the output at 1 V with the shift adjuster.
- Allow the whole beam to be received to enter into the lightest condition and set the output at 5 V with the span adjuster.
- For more accurate calibration, repeat ① and ②.

Explanation

(e.g.) Wire detection

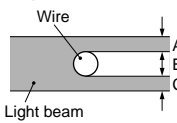

- Incident beam width = A + C
- Interrupted beam width = B
- Lightest condition: The entire beam is received.
- Darkest condition: The entire beam is interrupted.

Further use of shift adjuster

- If you want to change the output voltage value after the calibration, the shift adjuster enables you to shift the analog voltage up or down within about ± 0.5 V.

(e.g.) To shift the analog voltage from 2.51 V to 3.00 V with a certain amount of beam interruption

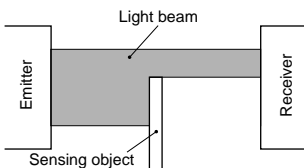

	Before adjustment	After adjustment
Darkest condition	1.00 V	1.49 V
Setting condition	2.51 V	3.00 V
Lightest condition	5.00 V	5.49 V

Application: When two sensor heads are used to measure the width of a sheet, the shift adjuster can eliminate the need to move the sensor heads during set-up.

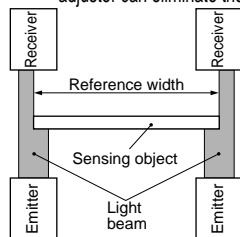

Up to now, the sensor heads have had to be located at the exact positions with respect to the reference object to obtain a 3 V (center of 1 to 5 V) sensor analog output. However, even a simulated center is easily obtained by shift adjustment without any realignment.

Note: To make the whole beam balanced between the lightest and the darkest conditions, the sensor heads should be positioned where the sensor generates 3 V analog output.

Adjusting HIGH & LOW output levels (two independent outputs)

HIGH output threshold level

- Block as much of the beam for which you want the HIGH output. Turn the HIGH adjuster to just before the point where the HIGH operation indicator lights up. The threshold level increases as the adjuster is turned clockwise.

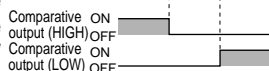
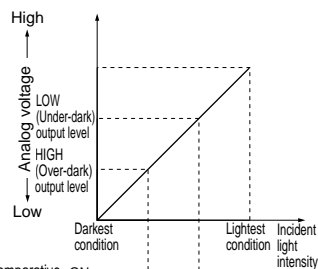

LOW output threshold level

- Again, block as little of the beam for which you want the LOW output. Turn the LOW adjuster to just before the point where the LOW operation indicator lights up. The threshold level increases as the adjuster is turned clockwise.

Note: Either HIGH or LOW setting can be made first.

External synchronization

- The external synchronization input controls the timing or the effective duration of the two comparative outputs. Either edge or gate trigger is selectable.

	Gate trigger	Edge trigger
External synchronization selection switch		
Sensing signal	ON: OFF:	ON: OFF:
External synchronization signal (Voltage between ES+ and ES-)	High: Low:	High: Low:
Comparative outputs (HIGH, LOW)	ON: OFF:	ON: OFF:

External synchronization input signal: Low ... 0 to 1 V, High ... + V or open

Note: If external synchronization is not used, set the external synchronization selection switch on 'Gate trigger' and short-circuit the external synchronization inputs (ES+ and ES-).

Wiring

- Make sure that the power supply is off while wiring.
- Verify that the supply voltage variation is within the rating.
- If power is supplied from a commercial switching regulator, ensure that the frame ground (F.G.) terminal of the power supply is connected to an actual ground.
- In case noise generating equipment (switching regulator, inverter motor, etc.) is used in the vicinity of the sensor head or the amplifier connect the frame ground (F.G.) terminal of the equipment to an actual ground.
- Do not run the wires together with high voltage lines or power lines or put them in the same raceway. This can cause malfunction due to induction.

Others

- The sensor's output is proportional to the amount of the LED light received. Since there is some variation in the light intensity at the center and the periphery of the sensing area, take care that 'output = dimension' may not hold.
- For stable operation, use the sensor 10 min., or more, after switching on the power supply.
- Avoid dust, dirt, and steam.
- Take care that the sensor does not come in direct contact with water, oil, grease, or organic solvents, such as, thinner, etc.
- Keep the front faces of the sensor heads free of dust, dirt, metal powder, etc. Should the faces be covered with it, deteriorating its performance, wipe them clean with a soft cloth or blown air.
- Take care that the sensor head is not directly exposed to fluorescent light from a rapid-starter lamp or a high frequency lighting device, as it may affect the sensing performance.

LA-300

DIMENSIONS (Unit: mm in) The CAD data in the dimensions can be downloaded from the SUNX website: <http://www.sunx.co.jp/>

LA-310 Sensor head

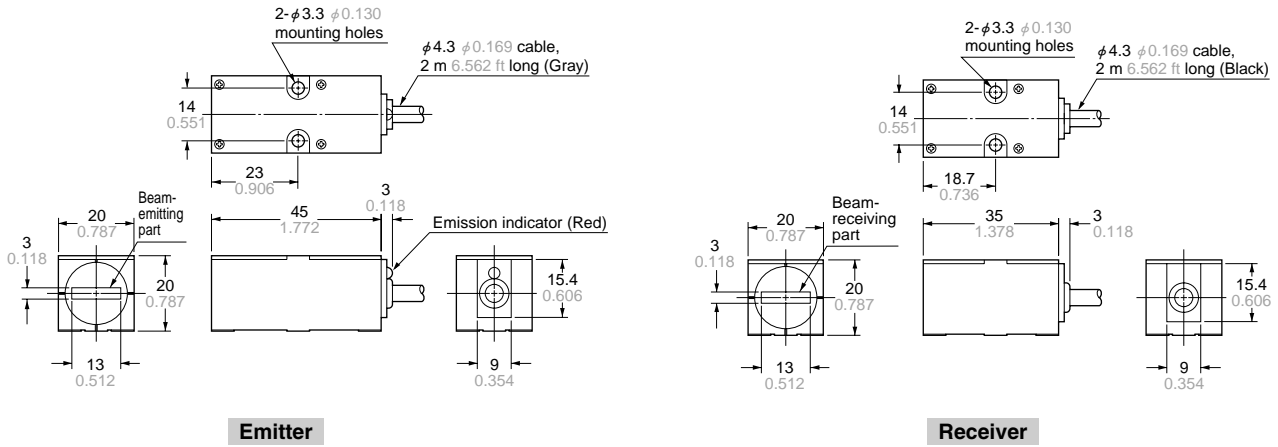

LA-305 Sensor head

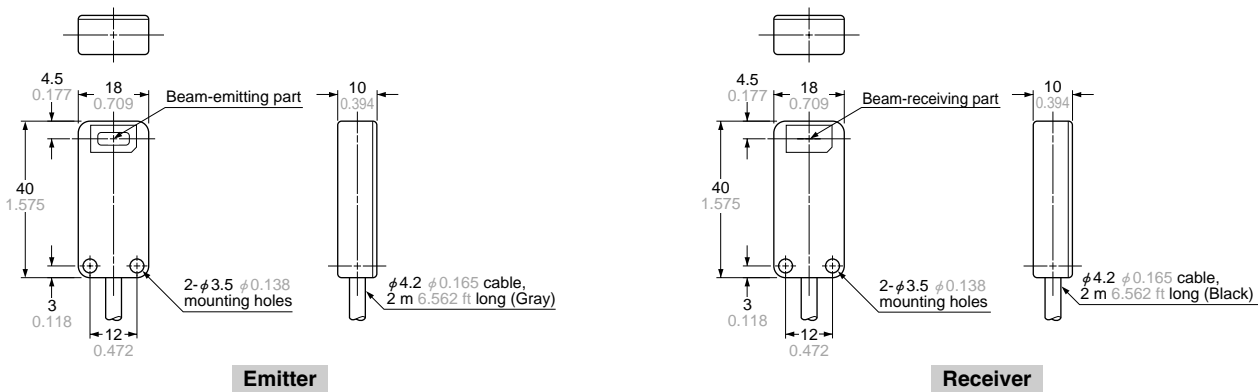

LA-A1 LA-A1P Amplifier

