



WAFER MAPPING SENSOR **LED beam reflective type**

**New**

# M-DW1



## Sensible nitride-coated wafers

Meet the new industry standard for wafer sensing.  
LED beam reflective type sensor allows you to see the red spot.

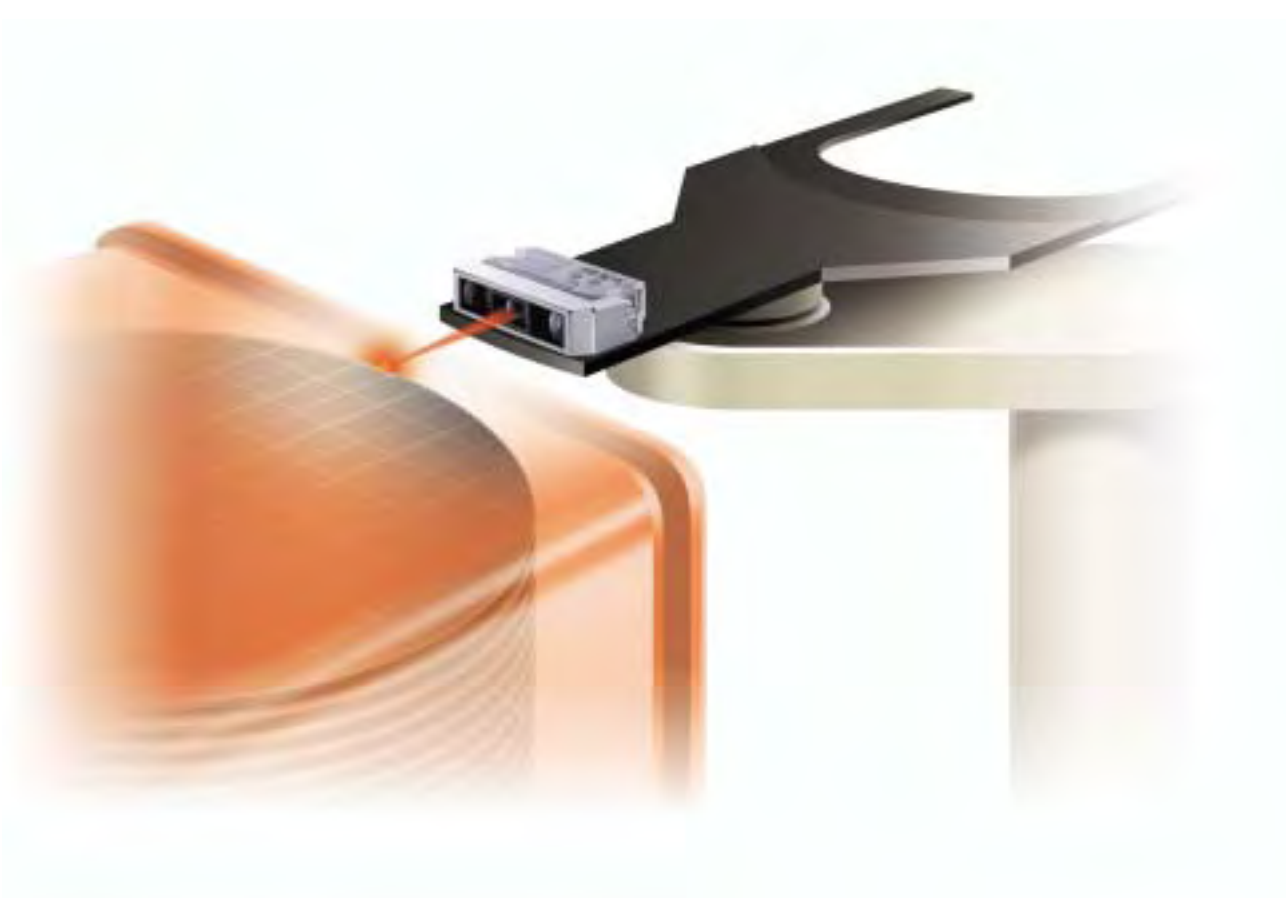

# The industry-first 'LED reflective type sensor' sets the new standard for new-age mapping sensors.

For more safety and more sensing accuracy, we studied the requirements for the future wafer mapping sensor from various aspects. Our answer is the LED beam reflective type wafer mapping sensor M-DW1.

This sensor uses LEDs as a light source for safe operation, and 2-segment receiving element for more accurate position detection.

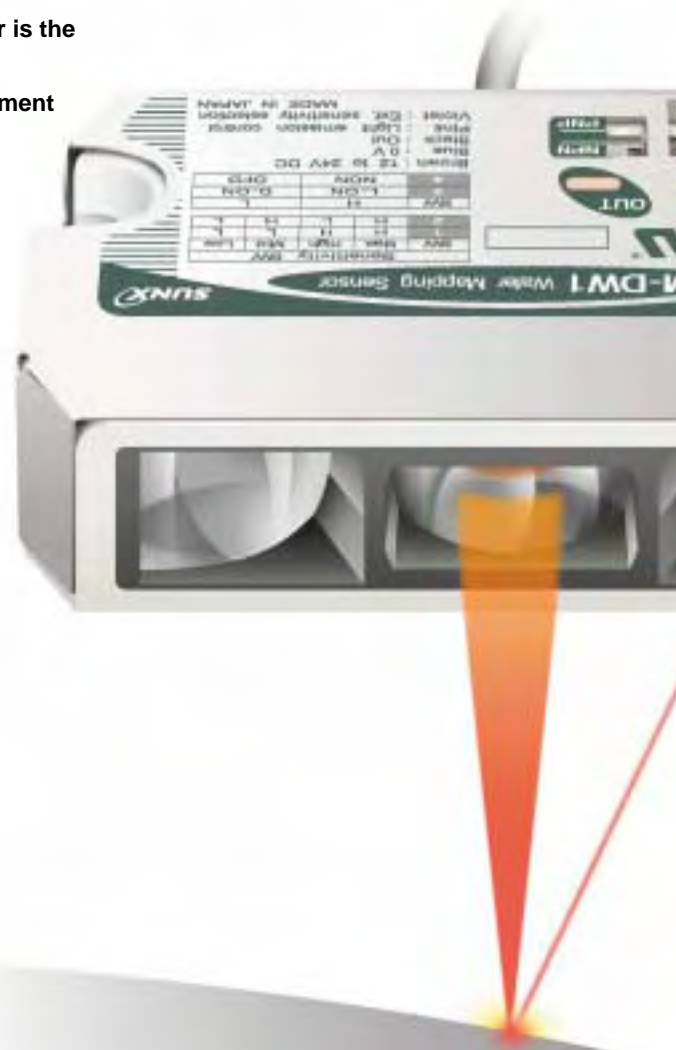

## All new mapping sensor, proving safety, detection ability, and ease of use

### Safe LEDs Adopted

Laser mapping sensor is dangerous, because when mapping from inside the loading port, the laser beam which misses the FOUP is directed toward the operator. The **M-DW1** which uses a LED light source is much safer than the conventional laser beam mapping sensor.

### Sensing of Nitride-coated Wafers Possible

Nitride-coated wafers absorb light at certain wavelengths depending on the coating thickness.

If the sensor uses the laser beam having a single wavelength, the beam may be absorbed completely, resulting in wafer detection error. The **M-DW1** uses an LED light source having a wavelength band, so that it can always detect nitride-coated wafers successfully.

Industry-first

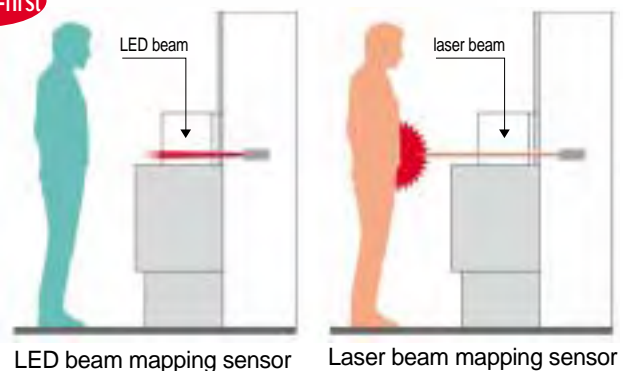



## Various features for enabling quick, accurate, and secure position detection

### Precise Position Detection by 2-segment Receiving Element

Wafer detection by the amount of reflected light may sometimes fail depending on the wafer edge shape. The **M-DW1** uses 2-segment receiving element in the beam-receiving part, and detects wafers by the reflected light position instead of the amount of reflected light. Thus, the sensor is less affected by wafer thickness or the amount of reflected light.

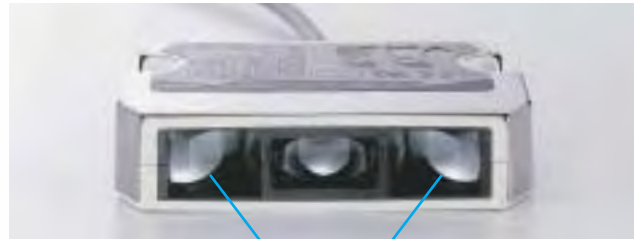

■ 2-segment receiving element

Reflected light

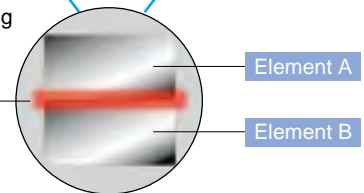

### Glass Wafers Are Also Detectable

Recent trend shows a rapid increase of glass wafers. These wafers do not reflect much light and, therefore, their edge detection has been considered to be difficult. The **M-DW1**, which detects wafers not by the light amount but by the light position, can detect the glass wafers regardless of the light amount.

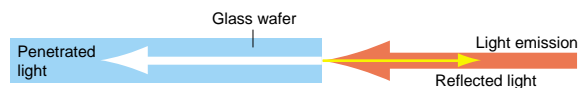

### High-speed Response Time: 0.5ms

The sensor responds in 0.5ms, meeting the requirements of both high speed and high accuracy in wafer detection.

## Flexible application according to your needs

### Compact and Lightweight Design with Built-in Amplifier

The sensor measures 80.6mm (W) × 18.3 mm (H) × 50mm (D), and weighs only 75g.

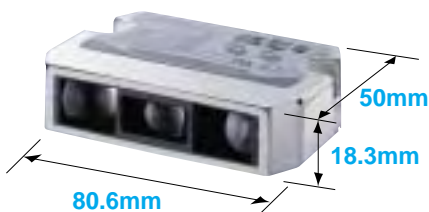

### 4-way Cable Direction

The sensor cable can be drawn in any of the four directions; rearward, rightward, leftward and downward. This provides more flexibility in installation of the sensor.



### Global Use

The sensor is designed in compliance with CE marking EMC Directive, and obtains UL Recognition. In addition, the function for switching output method between NPN and PNP further makes the sensor usable all over the world.



## SPECIFICATIONS

Designation	LED beam reflective type wafer mapping sensor	
Item Model No.	<b>M-DW1</b>	
Center measuring distance	45mm	
Sensing object	3 inch or larger semiconductor wafer (Note 1)	
Detectable surface	Surface having a side edge which reflects light in the light receiving direction (Note 2)	
Sensing angle	$12.5 \pm 5^\circ$	
Wafer pitch	Separate sensing is possible at normal sensitivity for 3mm pitch or more	
Suitable cassette	SEMI standard FOUP cassette / open cassette	
Supply voltage	12 to 24V DC $\pm 10\%$ Ripple P-P 10% or less	
Current consumption	65mA or less	
Output	NPN output / PNP output, selectable with output selection switch <NPN output> NPN open-collector transistor <ul style="list-style-type: none"> <li>Maximum sink current: 100mA</li> <li>Applied voltage: 30V DC or less (between output and 0V)</li> <li>Residual voltage: 1V or less (at 100mA sink current) 0.4V or less (at 16mA sink current)</li> </ul>	
	<PNP output> PNP open-collector transistor <ul style="list-style-type: none"> <li>Maximum source current: 100mA</li> <li>Applied voltage: 30V DC or less (between output and +V)</li> <li>Residual voltage: 1V or less (at 100mA source current) 0.4V or less (at 16mA source current)</li> </ul>	
	Output operation	Light-ON / Dark-ON, selectable by switch
	Short-circuit protection	Incorporated (restored automatically)
Response time	500 $\mu$ s or less	
Operation indicator	Orange LED (lights up when the output is ON)	
Stability indicator	Green LED (lights up under stable light received condition or stable dark condition)	
Timer function	Approx. 2ms fixed OFF-delay timer, switchable either effective or ineffective	
Ambient temperature	0 to +55°C (No dew condensation), Storage: -10 to +70°C	
Material	Enclosure: ABS, Stainless steel (SUS301), Lens: Acrylic	
Cable	0.15mm <sup>2</sup> 5-core cabtyre cable, 300mm long	
Weight	75g approx.	

Notes: 1) In case of 8 inch or less wafers, the wafer pitch orientation flat or the surface condition may affect the sensing.  
2) Polished wafers, etc., which have a sharp edge cannot be detected since they do not reflect the light in the light receiving direction.

## DIMENSIONS (Unit: mm)

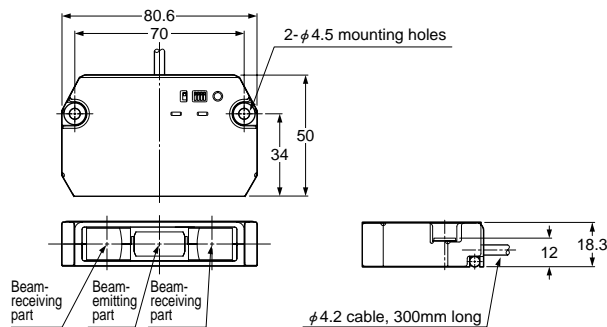

## I/O CIRCUIT DIAGRAMS

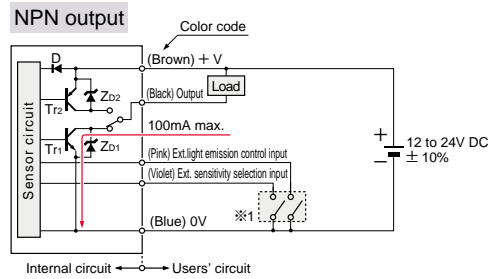

Symbols... D: Reverse supply polarity protection diode  
Zd1, Zd2: Surge absorption zener diode  
Tr1: NPN output transistor  
Tr2: PNP output transistor

※1

Non-voltage contact or NPN open-collector transistor

- External light emission control input  
0 to 3V, or 9V to +V (26.4V max.): Emission halted  
Open, or 4 to 8V: Emission
- External sensitivity selection input  
0 to 3V, or 9V to +V (26.4V max.): Input ON  
Open, or 4 to 8V: Input OFF

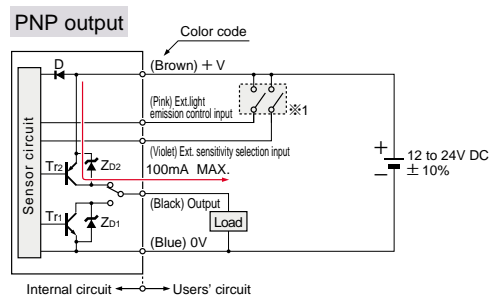

Symbols... D: Reverse supply polarity protection diode  
Zd1, Zd2: Surge absorption zener diode  
Tr1: NPN output transistor  
Tr2: PNP output transistor

※1

Non-voltage contact or PNP open-collector transistor

- External light emission control input  
0 to 3V, or 9V to +V (26.4V max.): Emission halted  
Open, or 4 to 8V: Emission
- External sensitivity selection input  
0 to 3V, or 9V to +V (26.4V max.): Input ON  
Open, or 4 to 8V: Input OFF

## PRECAUTIONS FOR PROPER USE

### Mounting

- Set the distance between the sensor detection surface and the wafer edge to be 45mm and mount the sensor so that sensing is done at an angle of 12.5° with respect to the wafer.

### Top-view

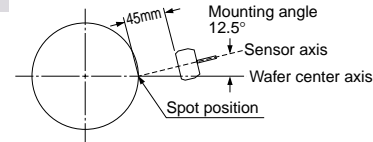

Note: If the wafer center axis and the sensor axis lie along a straight line, detection is not possible. Always mount the sensor at an angle to the wafer.



All information is subject to change without prior notice.