

SS-A5

Manually Sensitivity Set Photoelectric Sensor **Amplifier-separated**

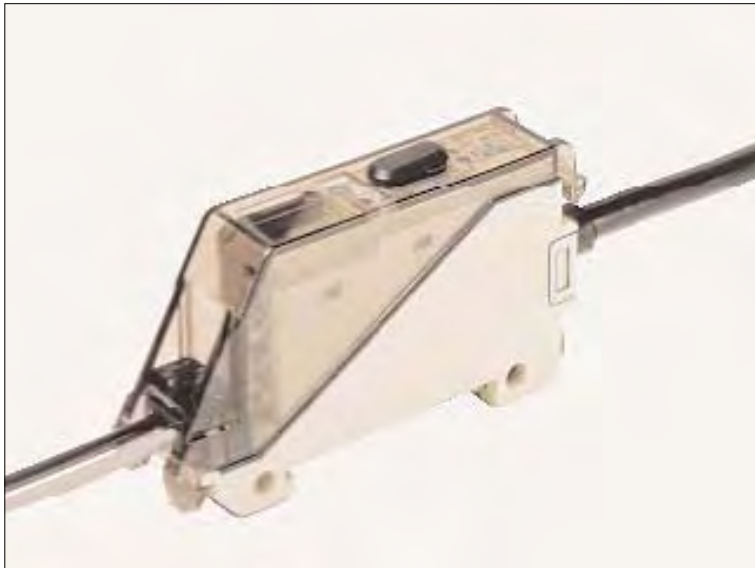

Twin adjuster enables delicate sensitivity setting

Twin adjuster

Its twin adjuster enables easy optimum setting to suit the application.

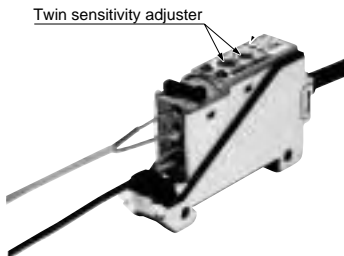

Automatic interference prevention

The **SS-A5** amplifier is incorporated with an automatic interference prevention function. Mutual interference does not occur even if two sensors are mounted adjacently.

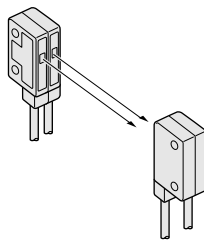

Quick sensor head connection

The **SS-A5** unique sensor head cable clamping mechanism reduces wiring time to 1/3 of conventional connection time. Just insert the cables into the amplifier and turn the lever. Even a screwdriver is not required.

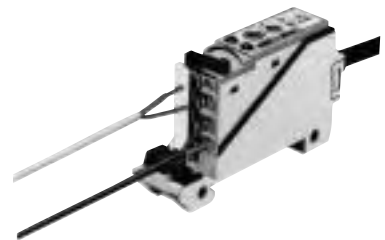

Self-diagnosis output

SS-A5 incorporates a self-diagnosis output, which provides a signal in case of unstable operating conditions due to beam misalignment, soiling of lens, etc.

OFF-delay timer

An OFF-delay timer which extends the output signal by a fixed period is incorporated. This is useful when the connected device has a slow response time or when small objects are being sensed and the output signal width is too small.

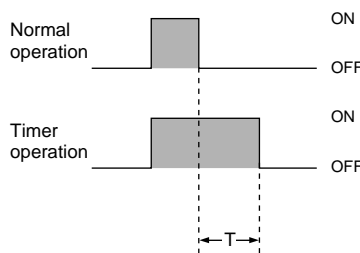

Timer period: T = 40 ms approx.

APPLICATIONS

Detecting ICs in transparent sticks

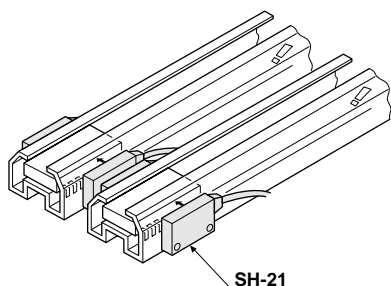

Detecting small bottles

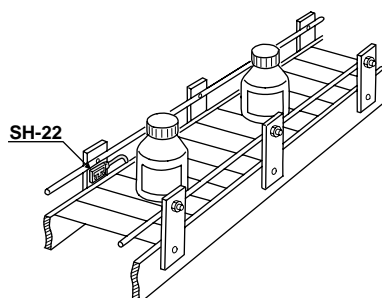

Sensing remaining tape

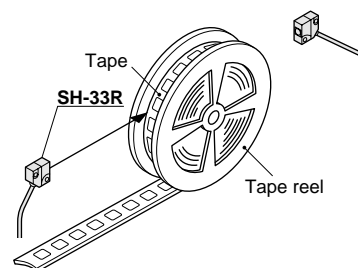

Detecting marks

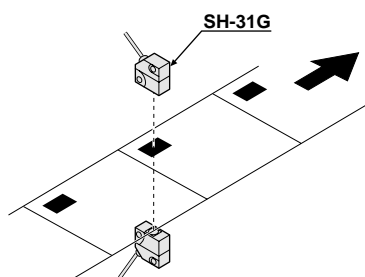

Detecting transparent glass substrate in cassette

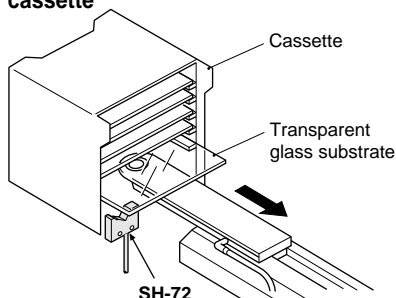

Detecting wafer

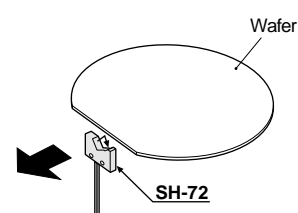

Ultra-slim type / SH-2

- Compact size: 0.3 cm³
Thickness: 3 mm 0.118 in



- Versatile mounting
Diffuse reflective type sensor head
- Front sensing



- Thru-beam type sensor head
- Front sensing
- Side sensing

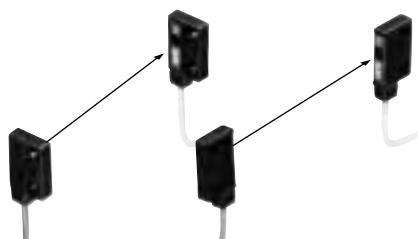

Ultra-small type / SH-3

- Sensor head with indicator
An operation indicator, which enables an easy check of the operation at site, has been incorporated.

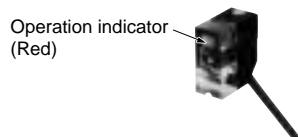

- Versatile, either top sensing or side sensing

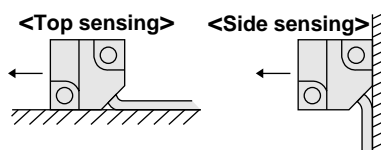

- 2 m 6.562 ft long sensing range with red LED beam (SH-33R)
Visible red LED beam makes alignment easy.

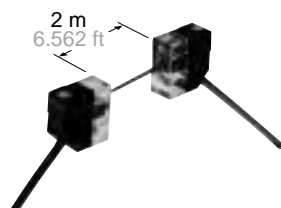

Glass substrate detection sensor / SH-72



- Reliable glass substrate detection
Its unique optical system enables stable detection of transparent glass substrate, as well as, specular film deposited glass substrate at the same distance.

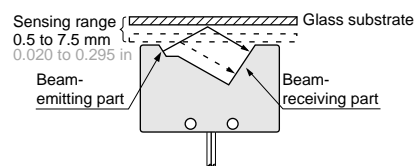

- No dead zone

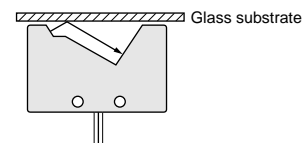

- Repeatability: 0.03 mm 0.001 in

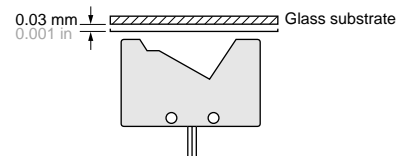

- Not affected by background

SS-A5

ORDER GUIDE

Amplifiers

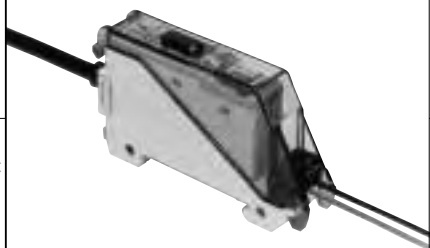



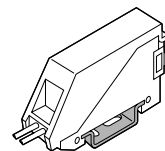

Type	Appearance	Model No.	Sensing output
3 m 9.843 ft cable length type		SS-A5	NPN open-collector transistor
5 m 16.404 ft cable length type		SS-A5-C5	

Accessory

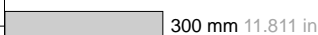
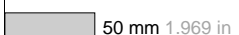
- **MS-DIN-1** (Amplifier mounting bracket)

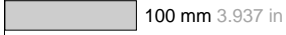

Sensor heads

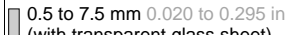
Type	Appearance	Sensing range	Model No.	Emitting element	Operation indicator
Ultra-slim	Thru-beam Front sensing		SH-21	Infrared LED	—
	Thru-beam Side sensing		SH-21E		
	Diffuse reflective Front sensing		SH-22		
Ultra-small	Thru-beam		SH-31R	Red LED	Incorporated
			SH-31G	Green LED	
	Diffuse reflective		SH-33R	Red LED	
			SH-32R	Red LED	
Glass substrate detection sensor			SH-72	Infrared LED	—

OPTIONS

Designation	Model No.	Description																													
Slit mask (For SH-31R , SH-31G and SH-33R only)	OS-SS3	This is a convenient slit mask having four types of slits.																													
		<table border="1"> <thead> <tr> <th rowspan="2">Slit size</th> <th rowspan="2">Fitting</th> <th colspan="3">Sensing range</th> <th rowspan="2">Min. sensing object</th> </tr> <tr> <th>SH-31R</th> <th>SH-31G</th> <th>SH-33R</th> </tr> </thead> <tbody> <tr> <td rowspan="2">0.5 × 3 mm 0.020 × 0.118 in</td> <td>One side</td> <td>500 mm 19.685 in</td> <td>50 mm 1.969 in</td> <td>750 mm 29.528 in</td> <td rowspan="2">φ3 mm φ0.118 in</td> </tr> <tr> <td>Both sides</td> <td>250 mm 9.843 in</td> <td>25 mm 0.984 in</td> <td>400 mm 15.748 in</td> </tr> <tr> <td rowspan="2">1 × 3 mm 0.039 × 0.118 in</td> <td>One side</td> <td>700 mm 27.559 in</td> <td>70 mm 2.756 in</td> <td>1,000 mm 39.370 in</td> <td rowspan="2">φ3 mm φ0.118 in</td> </tr> <tr> <td>Both sides</td> <td>500 mm 19.685 in</td> <td>50 mm 1.969 in</td> <td>750 mm 29.528 in</td> </tr> </tbody> </table>	Slit size	Fitting	Sensing range			Min. sensing object	SH-31R	SH-31G	SH-33R	0.5 × 3 mm 0.020 × 0.118 in	One side	500 mm 19.685 in	50 mm 1.969 in	750 mm 29.528 in	φ3 mm φ0.118 in	Both sides	250 mm 9.843 in	25 mm 0.984 in	400 mm 15.748 in	1 × 3 mm 0.039 × 0.118 in	One side	700 mm 27.559 in	70 mm 2.756 in	1,000 mm 39.370 in	φ3 mm φ0.118 in	Both sides	500 mm 19.685 in	50 mm 1.969 in	750 mm 29.528 in
		Slit size			Fitting	Sensing range			Min. sensing object																						
			SH-31R	SH-31G		SH-33R																									
0.5 × 3 mm 0.020 × 0.118 in	One side	500 mm 19.685 in	50 mm 1.969 in	750 mm 29.528 in	φ3 mm φ0.118 in																										
	Both sides	250 mm 9.843 in	25 mm 0.984 in	400 mm 15.748 in																											
1 × 3 mm 0.039 × 0.118 in	One side	700 mm 27.559 in	70 mm 2.756 in	1,000 mm 39.370 in	φ3 mm φ0.118 in																										
	Both sides	500 mm 19.685 in	50 mm 1.969 in	750 mm 29.528 in																											
Sensor head mounting bracket (For the ultra-small type only)	MS-SS3-1	Mounting bracket for the ultra-small sensor head (The thru-beam type sensor head needs two brackets.)																													
Amplifier mounting bracket	MS-FX-1	Mounting bracket for SS-A5																													
Sensor checker (Note)	CHX-SC2	It is useful for beam alignment of thru-beam type sensors. The optimum receiver position is given by indicators, as well as an audio signal.																													

Slit mask

- **OS-SS3**

The sensor head and the slit mask are mounted together.

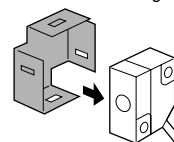

Sensor head mounting bracket

- **MS-SS3-1**

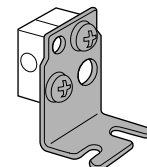

Two M3 (length 12 mm 0.472 in) screws with washers are attached.

Amplifier mounting bracket

- **MS-FX-1**

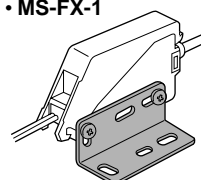

Sensor checker

- **CHX-SC2**

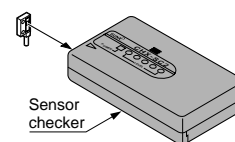

Two M3 (length 20 mm 0.787 in) screws with washers are attached.

Note: Refer to p.414~ for details of the sensor checker **CHX-SC2**.

SPECIFICATIONS

Refer to p.394~ for sensing characteristics.

Sensor heads

Item	Model No.	Ultra-slim			Ultra-small				Glass substrate detection sensor
		Thru-beam		Diffuse reflective	Thru-beam			Diffuse reflective	
		Front sensing	Side sensing		Red LED	Green LED	Red LED		
Applicable amplifier		SS-A5							
Sensing range		300 mm 11.811 in		50 mm 1.969 in (Note 1)	1 m 3.281 ft	100 mm 3.937 in	2 m 6.562 ft	100 mm 3.937 in (Note 1)	0.5 to 7.5 mm 0.020 to 0.295 mm (with transparent glass substrate)
Sensing object		Min. $\phi 0.3$ mm $\phi 0.012$ in opaque object (under the optimum condition) (Note 2)		Min. $\phi 0.3$ mm $\phi 0.012$ in copper wire with 3 mm 0.012 in setting distance and at the max. sensitivity	Min. $\phi 1$ mm $\phi 0.039$ in opaque object (with 1 m 3.281 ft setting distance and at the optimum sensitivity) (Note 3)	Min. $\phi 1$ mm $\phi 0.039$ in opaque object (with 100 mm 3.937 in setting distance and at the optimum sensitivity) (Note 3)	Min. $\phi 1$ mm $\phi 0.039$ in opaque object (with 2 m 6.562 ft setting distance and at the optimum sensitivity) (Note 3)	Opaque, translucent or transparent object	$\square 24$ mm 0.945 in or more transparent glass, aluminum-evaporated mirror, etc.
Hysteresis		—————		15 % or less of operation distance	—————			15 % or less of operation distance	5 % or less of operation distance
Repeatability (perpendicular to sensing axis)		0.03 mm 0.001 in or less		0.15 mm 0.006 in or less	0.1 mm 0.004 in or less			0.5 mm 0.020 in or less	0.03 mm 0.001 in or less (along sensing axis)
Operation indicator		—————			Red LED (lights up when the sensing output of the amplifier is ON, incorporated on the emitter of the thru-beam type sensor head)				—————
Environmental resistance	Protection	IP62 (IEC)			IP66 (IEC)				—————
	Ambient temperature	- 10 to + 60 °C + 14 to + 140 °F (Note 4) Storage: - 20 to + 70 °C - 4 to + 158 °F			- 25 to + 60 °C - 13 to + 140 °F (Note 4) Storage: - 30 to + 70 °C - 22 to + 158 °F				- 10 to + 60 °C + 14 to + 140 °F (Note 4) (including storage)
	Ambient humidity	35 to 85 % RH, Storage: 35 to 85 % RH							
	Ambient illuminance	Sunlight: 11,000 lx at the light-receiving face, Incandescent light: 3,500 lx at the light-receiving face							
	Vibration resistance	10 to 55 Hz frequency, 1.5 mm 0.059 in amplitude in X, Y and Z directions for two hours each							
	Shock resistance	500 m/s ² acceleration (50 G approx.) in X, Y and Z directions for three times each							
Emitting element		Infrared LED (modulated)			Red LED (modulated)	Green LED (modulated)	Red LED (modulated)		Infrared LED (modulated)
Material		Enclosure: Polycarbonate (glass fiber reinforced)			Enclosure: ABS, Lens: Polycarbonate				Enclosure: Polycarbonate
Cable		0.089 mm ² (ultra-slim type: 0.057 mm ²) single core (diffuse reflective type and glass substrate detection sensor: two parallel single core wires) shielded cable, 3 m 9.843 ft long							
Cable extension		Extension up to total 5 m 16.404 ft (ultra-small type: 10 m 32.808 ft) is possible with an equivalent cable (thru-beam type: both emitter and receiver).							
Weight		Emitter: 12 g approx. Receiver: 12 g approx.		24 g approx.	Emitter: 10 g approx. Receiver: 10 g approx.			20 g approx.	25 g approx.
Accessory		Sensor head mounting screw: 2 sets (SH-22: 1 set)			—————				

- Notes: 1) The sensing range of the diffuse reflective type sensor is specified for white non-glossy paper (50 × 50 mm 1.969 × 1.969 in) as the object.
 2) The optimum condition is the condition when the sensitivity is adjusted so that the operation indicator just lights up at the given distance in the light received condition.
 3) The optimum sensitivity stands for the sensitivity level when the operation indicator just lights up in the light received condition.
 4) No dew condensation or icing is allowed.

SS-A5

SPECIFICATIONS

Amplifier

Type	Manually sensitivity set amplifier	
Item	Model No.	
	SS-A5	
Applicable sensor heads	SH-2□, SH-3□, SH-72	
Supply voltage	12 to 24 V DC \pm 10 % Ripple P-P 10 % or less	
Current consumption	40 mA or less	
Sensing output	NPN open-collector transistor <ul style="list-style-type: none"> • Maximum sink current: 100 mA • Applied voltage: 30 V DC or less (between sensing output and 0 V) • Residual voltage: 1.5 V or less (at 100 mA sink current) 0.4 V or less (at 16 mA sink current) 	
Output operation	Selectable either Light-ON or Dark-ON with the operation mode switch	
Short-circuit protection	Incorporated	
Self-diagnosis output	NPN open-collector transistor <ul style="list-style-type: none"> • Maximum sink current: 50 mA • Applied voltage: 30 V DC or less (between self-diagnosis output and 0 V) • Residual voltage: 1 V or less (at 50 mA sink current) 0.4 V or less (at 16 mA sink current) 	
Output operation	ON under stable sensing condition	
Short-circuit protection	_____	
Response time	1 ms or less	
Operation indicator	Red LED (lights up when the sensing output is ON)	
Stability indicator	Green LED (lights up under stable light received condition or stable dark condition)	
Sensitivity adjuster	Continuously variable twin adjusters	
Automatic interference prevention function	Incorporated (Two units of sensors can be mounted close together.)	
Timer function	Approx. 40 ms fixed OFF-delay timer, selectable either effective or ineffective	
Environmental resistance	Ambient temperature	- 25 to + 60 °C - 13 to + 140 °F (No dew condensation or icing allowed), Storage: - 30 to + 70 °C - 22 to + 158 °F
	Ambient humidity	35 to 85 % RH, Storage: 35 to 85 % RH
	Noise immunity	Power line: 240 Vp, and 0.5 μ s pulse width; Radiation: 300 Vp, and 0.5 μ s pulse width (with noise simulator)
	Voltage withstandability	1,000 V AC for one min. between all supply terminals connected together and enclosure
	Insulation resistance	20 M Ω , or more, with 500 V DC megger between all supply terminals connected together and enclosure
	Vibration resistance	10 to 55 Hz frequency, 1.5 mm 0.059 in amplitude in X, Y and Z directions for two hours each
	Shock resistance	100 m/s ² acceleration (10 G approx.) in X, Y and Z directions for three times each
Material	Enclosure: Heat-resistant ABS, Cover: Polyethersulfone	
Cable	0.2 mm ² 4-core cabtyre cable, 3 m 9.843 ft long	
Cable extension	Extension up to total 100 m 328.084 ft is possible with 0.3 mm ² , or more, cable.	
Weight	120 g approx.	
Accessories	MS-DIN-1 (Amplifier mounting bracket): 1pc., Adjusting screwdriver: 1 pc., Adjuster cap: 1 pc.	

I/O CIRCUIT AND WIRING DIAGRAMS

I/O circuit diagram

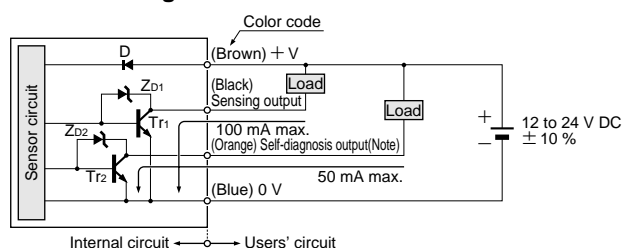

Note: The self-diagnosis output does not incorporate a short-circuit protection circuit. Do not connect it directly to a power supply or a capacitive load.

Symbols ... D: Reverse supply polarity protection diode
 ZD1, ZD2: Surge absorption zener diode
 Tr1, Tr2: NPN output transistor

Wiring diagram to sensor head

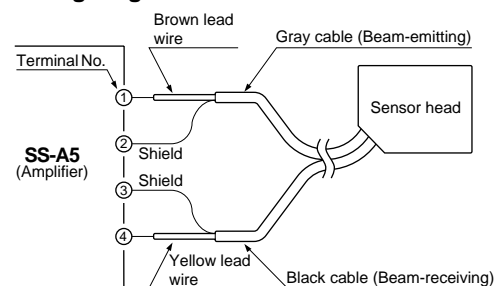

PRECAUTIONS FOR PROPER USE Refer to p.1135~ for general precautions and p.396~ for precautions for sensor head.

 This product is not a safety sensor. Its use is not intended or designed to protect life and prevent body injury or property damage from dangerous parts of machinery. It is a normal object detection sensor.

Always use the sensor head and the exclusive amplifier together as a set.

Cable extension for sensor head

- If the attached sensor head cables need to be extended, use two single core shielded cables of at least equivalent quality.

If a joint terminal or connector is used for extension, refer to the figures below. (The shielded extension cable must be of $\phi 1.45\text{ mm}$ $\phi 0.057\text{ in}$ outer diameter.)

Connection with joint terminal

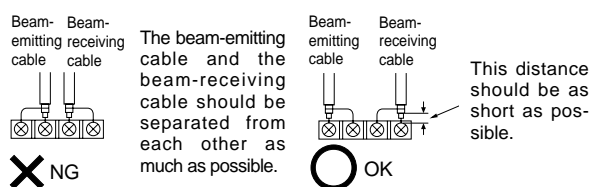

Connection with metal connector

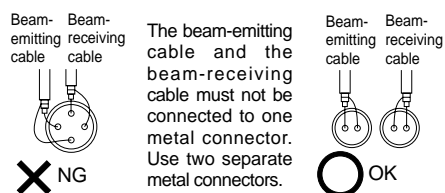

Connection to sensor head

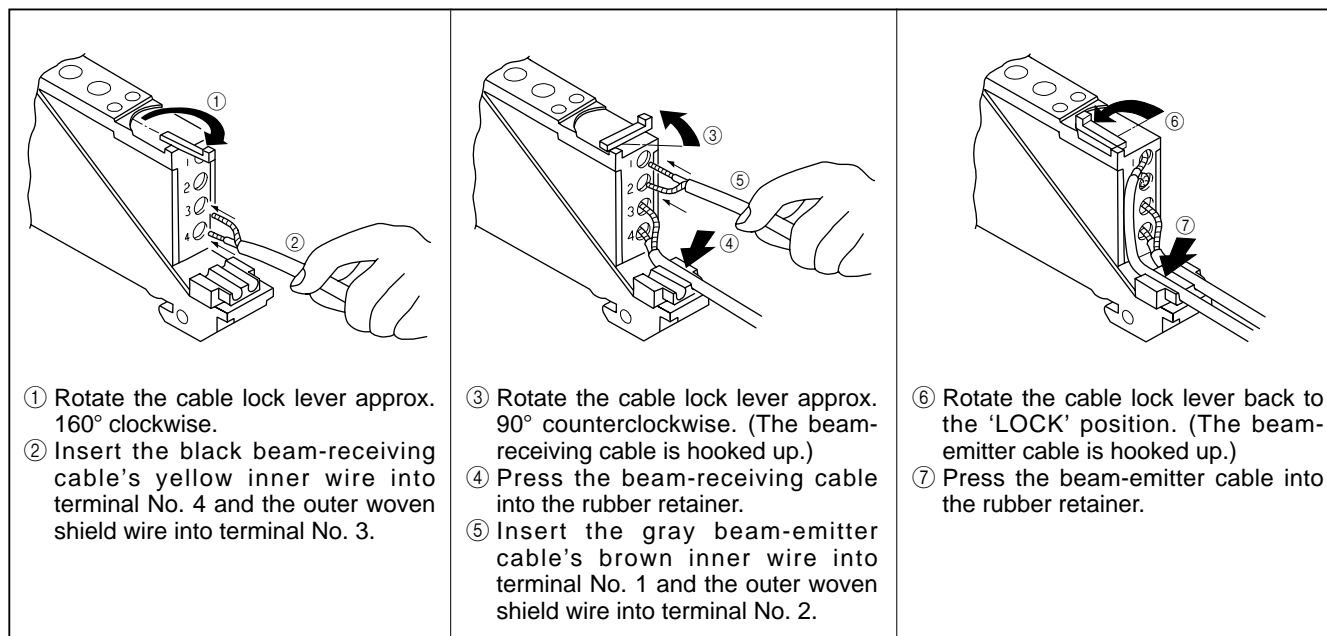

Note: Close the case cover firmly. Not doing so will weaken the shield cable clamp.

Trimming sensor head cables

- Trim the ends of sensor head cables as follows.

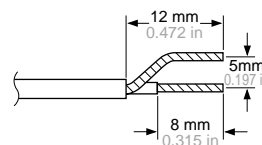

- In case of the reflective type sensor heads, with two parallel cables, the beam-emitting cable must be longer than the beam-receiving cable as shown below.

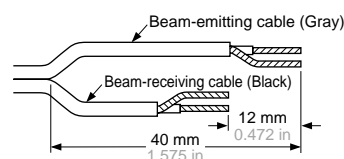

Note: Do not solder the cable ends.

SS-A5

PRECAUTIONS FOR PROPER USE

Refer to p.1135~ for general precautions and p.396~ for precautions for sensor head.

Mounting

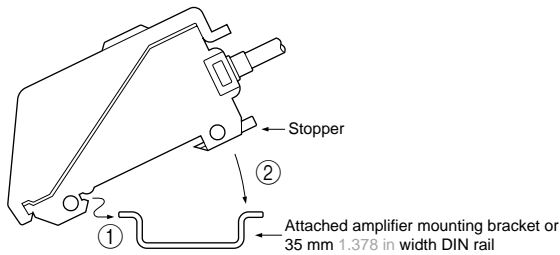

- ① Fit the front part of the amplifier on the attached amplifier mounting bracket (**MS-DIN-1**) or a 35 mm 1.378 in width DIN rail.
- ② Press down the rear part of the amplifier on the attached amplifier mounting bracket (**MS-DIN-1**) or the DIN rail to fit it.

※ To remove the amplifier, pull the stopper backwards.

- When the amplifier is fixed with screws and nuts, the tightening torque should be 0.58 N·m or less.

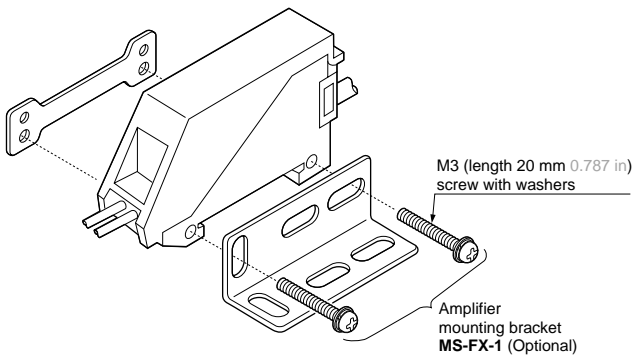

Wiring

- The self-diagnosis output does not incorporate a short-circuit protection circuit. Do not connect it directly to a power supply or a capacitive load.

Others

- Do not use during the initial transient time (30 ms) after the power supply is switched on.

Self-diagnosis function

- The sensor checks the incident light intensity, and if it is reduced due to dirt or dust, or beam misalignment, an output is generated.

Time chart

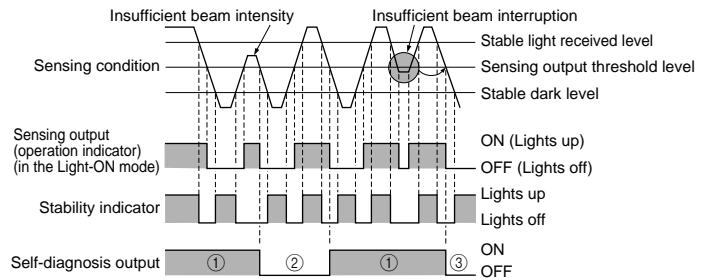

- ① The self-diagnosis output transistor stays in the 'ON' state during stable sensing.
- ② When the sensing output changes, if the incident light intensity does not reach the stable light received level or the stable dark level, the self-diagnosis output becomes OFF. Further, the self-diagnosis output changes state when the sensing output changes from Light to Dark state.
(It is not affected by the operation mode switch).
- ③ In case of insufficient beam interruption, there will be a time lag before the self-diagnosis output turns OFF.

Timer operation

- If the timer operation mode switch is set to 'OFD', approx. 40 ms fixed OFF delay timer operation is obtained. This function is useful if the output signal is so short that the connected device cannot respond.

Operation of timer operation mode switch

Timer operation mode switch setting	Sensing mode selection	Sensing condition	Operation
OFD	MODE L. D.	Beam received	ON
OFD	MODE L. D.	Beam interrupted	OFF
OFD	MODE L. D.	Beam received	ON
OFD	MODE L. D.	Beam interrupted	OFF
OFD	MODE L. D.	Beam received	ON
OFD	MODE L. D.	Beam interrupted	OFF
OFD	MODE L. D.	Beam received	ON
OFD	MODE L. D.	Beam interrupted	OFF

Timer period: T = 40 ms approx.

PRECAUTIONS FOR PROPER USE Refer to p.1135~ for general precautions and p.396~ for precautions for sensor head.

Sensitivity adjustment

- The **SS-A5** amplifier incorporates a coarse sensitivity adjuster and a fine sensitivity adjuster. The sensitivity adjuster and the adjustment procedure are different depending on whether a coarse setting is to be done or a fine difference is to be sensed. Hence, adjust to the optimum sensitivity as per the procedure given below.

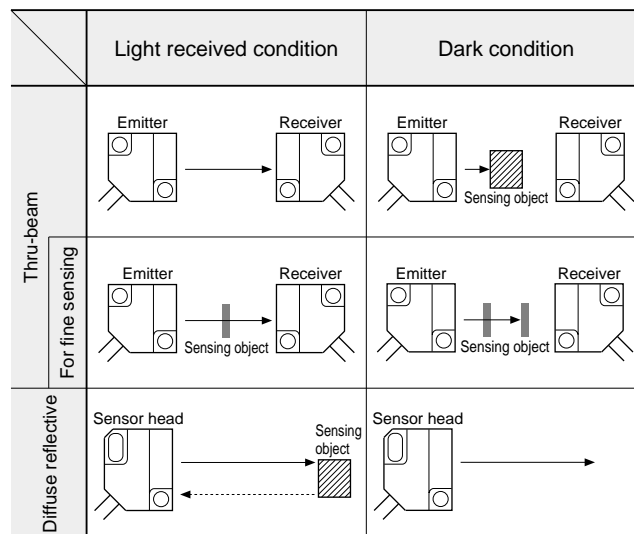
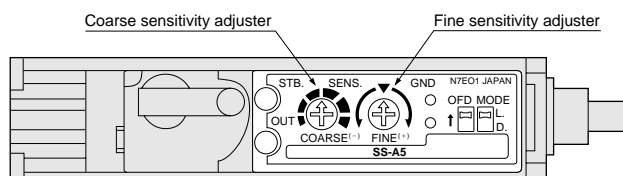

Coarse sensing

Step	Adjustment	Coarse sensitivity adjuster	Fine sensitivity adjuster
①	Set the fine sensitivity adjuster at MAX. and the coarse sensitivity adjuster at MIN.		
②	Under the light received condition, turn the coarse sensitivity adjuster gradually clockwise. Find out the point (A) at which the sensor enters the Light state operation.	ON in the light received condition 	At MAX. position
③	Under the dark condition, turn the coarse sensitivity adjuster further clockwise until the sensor enters the Light state operation. Once it changes state, turn the coarse sensitivity adjuster gradually counterclockwise to determine the point (B) where the sensor re-enters the Dark state operation.	OFF in the dark condition 	
④	Set the adjuster at the center between the points (A) and (B).	Optimum sensitivity 	

Fine sensing

Step	Adjustment	Coarse sensitivity adjuster	Fine sensitivity adjuster
①	Set the fine sensitivity adjuster at the center and the coarse sensitivity adjuster at MIN.		Center
②	Under the light received condition, turn the coarse sensitivity adjuster gradually clockwise until the sensor enters the Light state operation.	ON in the light received condition 	Center
③	Next, turn the fine sensitivity adjuster counterclockwise until the sensor returns to the Dark state operation. Once it changes state, turn the fine sensitivity adjuster gradually clockwise to determine the point (A) where the sensor re-enters into the Light state operation.	Leave at above setting	ON in the light received condition Center
④	Under the dark condition, turn the fine sensitivity adjuster further clockwise until the sensor enters the Light state operation. Once it changes state, turn the fine sensitivity adjuster gradually counterclockwise to determine the point (B) when the sensor re-enters the Dark state operation.		OFF in the dark condition
⑤	Set the fine sensitivity adjuster at the center between the points (A) and (B).		Optimum sensitivity

SS-A5

DIMENSIONS (Unit: mm in) The CAD data in the dimensions can be downloaded from the SUNX website: <http://www.sunx.co.jp/>
Refer to p.402~ for dimensions for sensor head.

SS-A5 Amplifier

MS-DIN-1 Amplifier mounting bracket (Accessory for SS-A5)

Assembly dimensions with attached amplifier mounting bracket

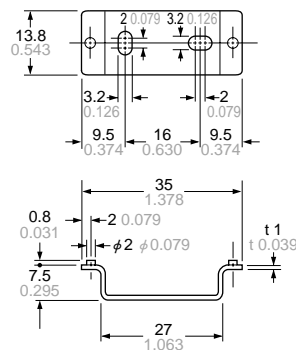
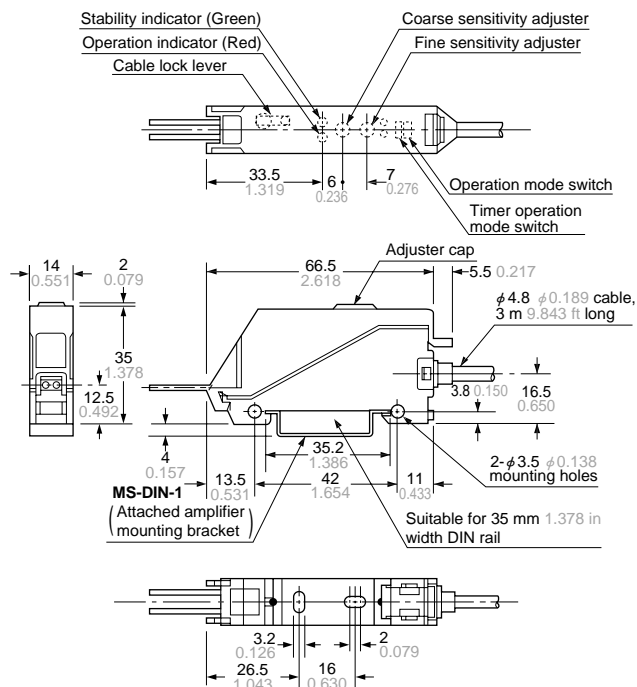

Material: Cold rolled carbon steel (SPCC)
(Uni-chrome plated)

MS-FX-1 Amplifier mounting bracket (Optional)

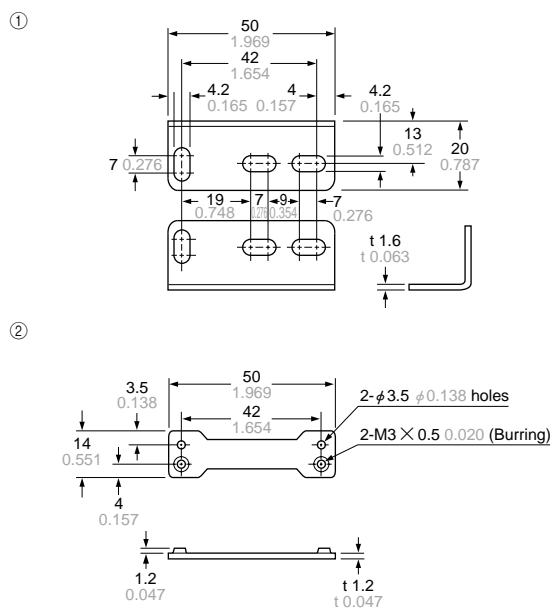

Material: Cold rolled carbon steel (SPCC)
(Uni-chrome plated)
Two M3 (length 20 mm 0.787 in) screws with washers are attached.