

FZ-10 SERIES

Color Detection Fiber Sensor



Reliable and precise color discrimination



Red, green and blue LEDs

FZ-10 incorporates red, green and blue LEDs as its beam sources, which promise longer lifetime and greater immunity against extraneous light than fluorescent lamps and are also maintenance free.

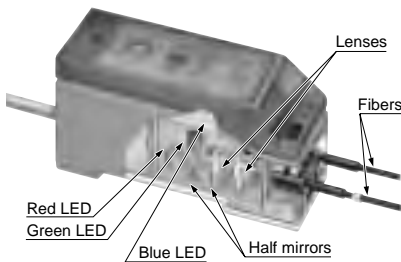

Excellent color detectability

Each of the red, green and blue components is digitally processed so that precise color discrimination is possible. FZ-10 can discriminate between white and yellow or distinguish if a surface is plated or not, that could never be possible with conventional fiber sensors which were based on detection of light intensity.



Can discriminate between white and yellow surfaces.



Dully gold-plated surface is reliably detected.

Easy set up

Just pressing a button recognizes the reference color you want to detect as the criterion. There are two methods to set the criterion, manual teaching and auto-teaching. The tolerance adjuster also allows you to set the tolerance of color equivalence in 16 grades.

Criterion

Manual teaching

Place a workpiece bearing the reference color under the fiber head and press the teaching button.

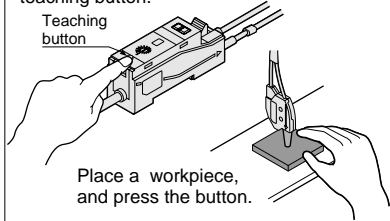

Auto-teaching

Keep pressing the teaching button until a workpiece bearing the reference color travels past the fiber head.

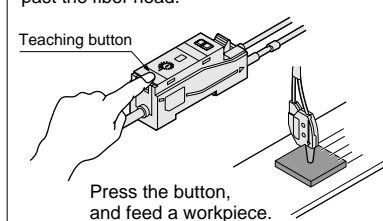

Tolerance adjustment

Precise judgment

Tolerance adjuster



Turn the adjuster clockwise. The closer it is to 'FINE', finer is the set tolerance.



Reference color (Criterion)



The adjuster determines the tolerance of equivalence with respect to the reference color.

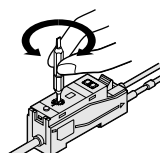

Rough judgment

Tolerance adjuster



Turn the adjuster counterclockwise. The closer it is to the '▲' mark, coarser is the set tolerance.



APPLICATIONS

Detecting labels on different colored objects

Even if objects are differently colored, **FZ-10** reliably detects the same color label.

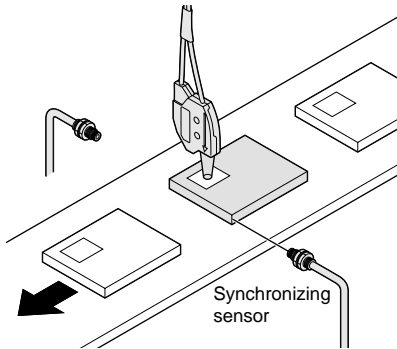

Evaluating if objects are plated or not (Note 1)

Its precise color resolution discriminates a bare metal surface from a plated metal surface.

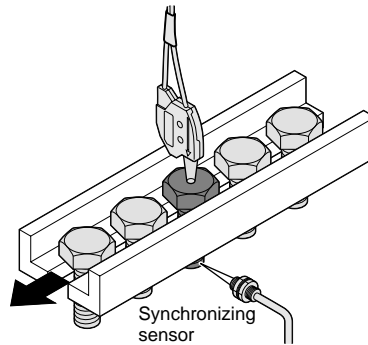

Detecting seals on boxes

It can reliably detect the presence of a seal on every package in the pharmaceutical, cosmetic, food, tobacco, and software industries.

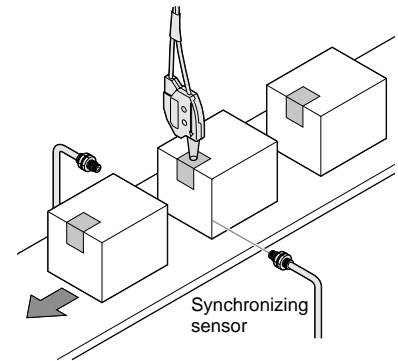

Notes: 1) **FD-L52** fiber head (high precision type) or **FD-L53** fiber head (extremely small spot type) is recommended for applications in which specular objects, having a high reflective index are to be detected, e.g., evaluating if metal objects are plated or not. **FD-L54** fiber head (long sensing range type) is recommended for applications where the object wavers on the assembly line.
2) **FZ-10** may not be able to detect color depending on object shape, color, glossiness, etc. Please test before actual use and contact our office if you have any questions.

Miniature & space-effective

The amplifier is only $W20 \times H31.5 \times D67$ mm $W0.787 \times H1.240 \times D2.638$ in in size and the fiber head is just 7 mm 0.276 in, 8 mm 0.315 in or 12 mm 0.472 in thick, so that it is mountable in a tight space.

Amplifier

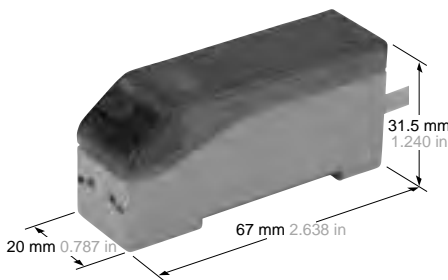

Four types of fibers are available

The fiber can be selected according to the application and object size. The color of even a small object can be reliably detected.

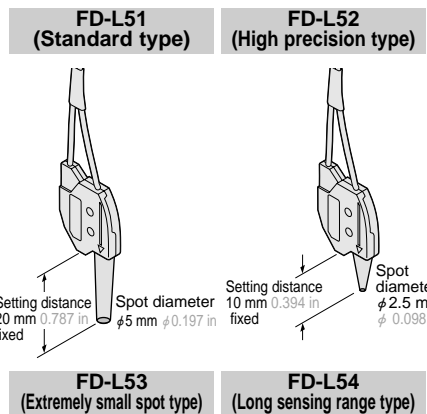

High-speed response time: 1 ms

Small traveling objects can be sensed even on a high-speed production line, due to its response time of 1 ms.

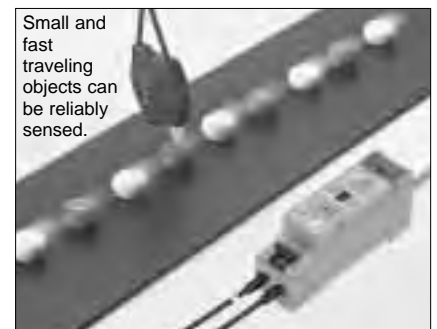

Fibers

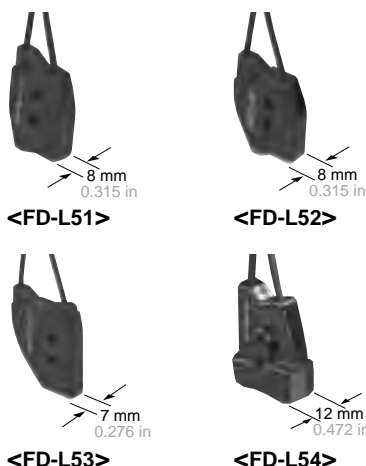

FD-L52 fiber head (high precision type) or **FD-L53** fiber head (extremely small spot type) is recommended for applications in which specular objects, having a high reflective index are to be detected, e.g., evaluating if metal objects are plated or not. **FD-L54** fiber head (long sensing range type) is recommended for applications where the object wavers on the assembly line.



FZ-10

ORDER GUIDE

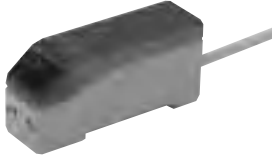
Amplifiers

Type	Appearance	Model No.	Emitting element	Output
NPN output type		FZ-11	Red LED Green LED Blue LED	NPN open-collector transistor
PNP output type		FZ-11P		PNP open-collector transistor

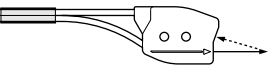
Fibers

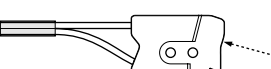
Type	Appearance	Setting distance	Spot diameter	Fiber cable length	Model No.
Standard		20 mm 0.787 in (fixed)	φ5 mm φ0.197 in (at the setting distance)	1 m 3.281 ft	FD-L51
High precision		10 mm 0.394 in (fixed)	φ2.5 mm φ0.098 in (at the setting distance)	1 m 3.281 ft	FD-L52
Extremely small spot		5 mm 0.197 in (fixed)	φ1 mm φ0.039 in (at the setting distance)	1 m 3.281 ft	FD-L53
Long sensing range		40 mm 1.575 in (fixed)	φ8 mm φ0.315 in (at the setting distance)	1 m 3.281 ft	FD-L54

Reference

Threaded head fiber

Color discrimination is also possible with **FD-B8/FM2/G4** (standard fiber for the **FX-301/302/303/311** series) in combination with the **FZ-10** series amplifier. As a standard fiber has a small head and is free-cut type, allowing you to cut the desired fiber cable length, it can be mounted in a narrow space.

FD-B8

Setting distance: 8 mm 0.315 in (fixed)

FD-FM2

Setting distance: 5 mm 0.197 in (fixed)

FD-G4

Setting distance: 4 mm 0.157 in (fixed)

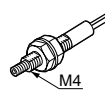
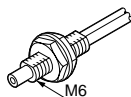
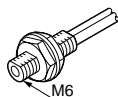

Caution: They cannot be used in an application which needs precision sensing.

Accessory

• MS-DIN-3

(Amplifier mounting bracket)

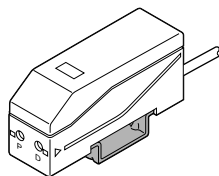

OPTIONS

Designation	Model No.	Description	
Universal sensor mounting stand (Note)	MS-AJ1-F	Horizontal mounting type	Mounting stand assembly for fiber
	MS-AJ2-F	Vertical mounting type	

Note: Refer to p.332~ for details of the universal sensor mounting stand.

Universal sensor mounting stand

Using the arm which enables adjustment in the horizontal direction, sensing can also be done from above an assembly line.

• MS-AJ1-F

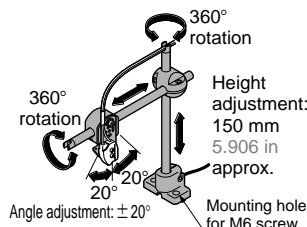

• MS-AJ2-F

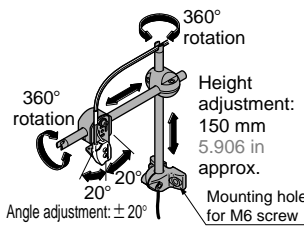

SPECIFICATIONS

Amplifiers

Item	Type	NPN output	PNP output
	Model No.	FZ-11	FZ-11P
Applicable fibers	FD-L51, FD-L52, FD-L53, FD-L54		
Supply voltage	12 to 24 V DC \pm 10 % Ripple P-P 10 % or less		
Current consumption	45 mA or less		
Sensing object	Opaque or translucent object larger than the spot diameter of the applicable fiber		
Output	NPN open-collector transistor		PNP open-collector transistor
	<ul style="list-style-type: none"> Maximum sink current: 100 mA Applied voltage: 30 V DC or less (between output and 0 V) Residual voltage: 1 V or less (at 100 mA sink current) 		<ul style="list-style-type: none"> Maximum source current: 100 mA Applied voltage: 30 V DC or less (between output and + V) Residual voltage: 1 V or less (at 100 mA source current)
	Utilization category	DC-12 or DC-13	
	Output operation	Switchable either Coincident-ON or Incoincident-ON	
Short-circuit protection	Incorporated		
Response time	1 ms or less (3 ms or less when auto-teaching has been engaged)		
Indicators	Power indicator: Green LED (lights up when the power is ON, blinks during auto-teaching) Operation indicator: Red LED (lights up when the output is ON) ※Both blink alternately when a manual teaching error occurs Both blink simultaneously when the output is short-circuited		
Timer function	Approx. 40 ms fixed OFF-delay timer (switchable either effective or ineffective)		
Teaching	Button operation, Switchable either manual-teaching or auto-teaching		
Tolerance	Adjustable in 16 grades with the tolerance adjuster		
Environmental resistance	Pollution degree	3 (Industrial environment)	
	Ambient temperature	- 10 to + 55 °C + 14 to + 131 °F (No dew condensation or icing allowed) (Note 1), Storage: - 20 to + 70 °C - 4 to + 158 °F	
	Ambient humidity	35 to 85 % RH, Storage: 35 to 85 % RH	
	Ambient illuminance	Sunlight: 10,000 lx at the light-receiving face, Incandescent light: 3,000 lx at the light-receiving face	
	EMC	EN 50081-2, EN 50082-2, EN 60947-5-2	
	Voltage withstandability	1,000 V AC for one min. between all supply terminals connected together and enclosure (Note 2)	
	Insulation resistance	20 M Ω , or more, with 250 V DC megger between all supply terminals connected together and enclosure (Note 2)	
	Vibration resistance	10 to 150 Hz frequency, 0.75 mm 0.030 in amplitude in X, Y and Z directions for two hours each	
Shock resistance	100 m/s ² acceleration (10 G approx.) in X, Y and Z directions for three times each		
Emitting element	Red LED • Green LED • Blue LED (modulated)		
Material	Enclosure: ABS, Case cover: Polycarbonate, Fiber lock lever: PPS		
Cable	0.2 mm ² 3-core cabtyre cable, 2 m 6.562 ft long		
Cable extension	Extension up to total 100 m 328.084 ft is possible with 0.3 mm ² , or more, cable.		
Weight	85 g approx.		
Accessories	MS-DIN-3 (Amplifier mounting bracket): 1 pc., Adjusting screwdriver: 1 pc.		

Notes: 1) The amplifier should be used under the ambient temperature of + 15 °C to + 35 °C + 59 °F to + 95 °F when the tolerance adjuster is set from the 1st grade to the 4th grade, which provide fine color resolution.
 2) The voltage withstandability and the insulation resistance values given in the above table are for the amplifier only.

Fiber Selection
 Digital Setting
 FX-301
 FX-302
 FX-303
 Bank Selection Unit
 FX-CH
 Manually Set
 FX-311
 Analog Output
 FX-11A
 Color Detection
 FZ-10

FZ-10

SPECIFICATIONS

Fibers

Type	Standard	High precision	Extremely small spot	Long sensing range	
Item	Model No.	FD-L51	FD-L52	FD-L53	FD-L54
Applicable amplifiers					
FZ-11, FZ-11P					
Sensing range (Note 1)	14 to 24 mm 0.511 to 0.945 in	8 to 11 mm 0.315 to 0.433 in	4 to 6 mm 0.157 to 0.236 in	30 to 50 mm 0.181 to 1.969 in	
Setting distance	20 mm 0.787 in (fixed)	10 mm 0.394 in (fixed)	5 mm 0.197 in (fixed)	40 mm 1.575 in (fixed)	
Spot diameter (at setting distance)	φ5 mm 0.197 in	φ2.5 mm 0.098 in	φ1 mm 0.039 in	φ8 mm 0.315 in	
Allowable bending radius	R25 mm 0.984 in or more (Note 2)				
Fiber cable length	1 m 3.281 ft				
Ambient temperature	- 20 to + 70 °C - 4 to + 158 °F (No dew condensation or icing allowed), Storage: - 20 to + 70 °C - 4 to + 158 °F				
Ambient humidity	35 to 85 % RH, Storage: 35 to 85 % RH				
Material	Fiber core: Acrylic, Sheath: Polyethylene, Fiber head: Polycarbonate, Lens: Polyallylate (FD-L54: Acrylic)				
Weight	15 g approx.				

Notes: 1) The sensing range of each fiber is the range for which white non-glossy paper can be detected at the sensitivity for which teaching has been done with a white non-glossy paper (50 × 50 mm 1.969 × 1.969 in) at the respective rated setting distance and at the 16th grade (▲ mark) of tolerance.
 2) If the fiber cable is bent at less than R25 mm 0.984 in or less, the detectability may deteriorate.
 3) Since fiber **FD-L51** (standard type) is easily affected by specular reflection, it is possible that teaching may not be properly done or sensing may be unstable if objects of high reflectivity (mirror, plated objects, copper foil, etc.) are sensed. When such objects are to be sensed, please use **FD-L52** (high precision type) or **FD-L53** (extremely small spot type) and make sure that the projected optical beam is perpendicular to the object surface.

I/O CIRCUIT AND WIRING DIAGRAMS

FZ-11 NPN output type

I/O circuit diagram

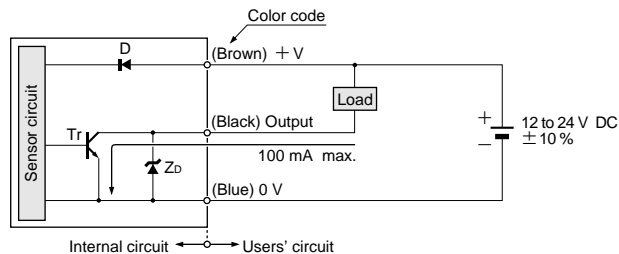

Wiring diagram

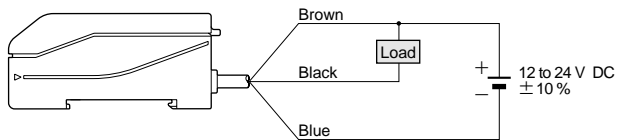

Symbols ... D : Reverse supply polarity protection diode
 Zd: Surge absorption zener diode
 Tr: NPN output transistor

FZ-11P PNP output type

I/O circuit diagram

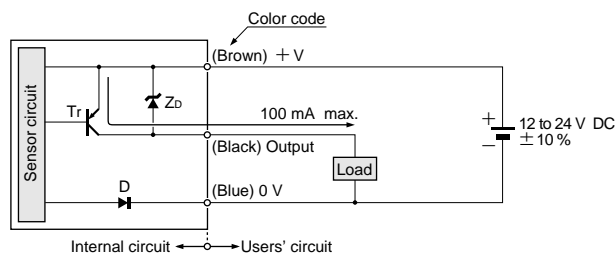

Wiring diagram

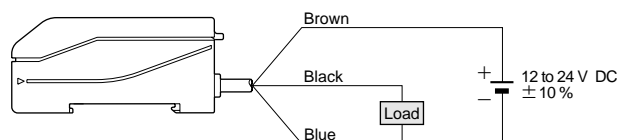

Symbols ... D : Reverse supply polarity protection diode
 Zd: Surge absorption zener diode
 Tr: PNP output transistor

PRECAUTIONS FOR PROPER USE

Refer to [p.1135](#)~ for general precautions.

Amplifier



This product is not a safety sensor. Its use is not intended or designed to protect life and prevent body injury or property damage from dangerous parts of machinery. It is a normal object detection sensor.

Mounting

How to mount the amplifier

- Fit the rear part of the amplifier on the attached amplifier mounting bracket (**MS-DIN-3**) or a 35 mm 1.378 in width DIN rail.
- Press down the front part of the amplifier on the amplifier mounting bracket (**MS-DIN-3**) or 35 mm 1.378 in width DIN rail to fit it.

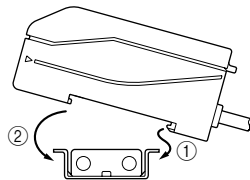

Attached amplifier mounting bracket or 35 mm 1.378 in width DIN rail

How to remove the amplifier

- Push the amplifier forward.
- Lift up the front part of the amplifier to remove it.

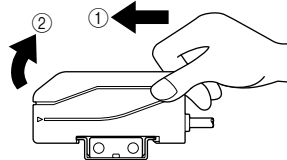

Note: Please take care that if the front part is lifted without pushing the amplifier forwards, the hooks on the rear portion of the mounting section are likely to break.

How to connect the fiber cables

- Unlock the fiber lock lever by lowering it.
- Insert the beam-emitting fiber cable tagged with the mark 'P' into the beam-emitting part 'P', and the beam-receiving fiber cable into the beam-receiving part 'D'. They should be inserted gradually until the position where they stop. If the emitting fiber cable and the receiving fiber cable are reversely inserted, proper operation cannot be obtained.
- Lock the fiber lock lever to the original position.

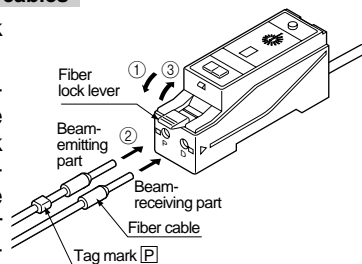

Functional description

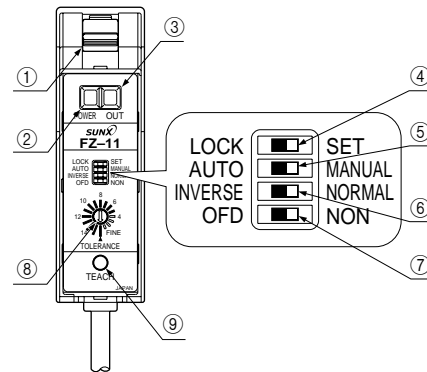

	Description	Function	
①	Fiber lock lever	Locks or unlocks fiber cables.	
②	Power indicator (Green LED)	Lights up when the power is ON, blinks during auto-teaching.	Both blink alternately when a manual teaching error occurs. Both blink simultaneously when the output is short-circuited.
③	Operation indicator (Red LED)	Lights up when the output is ON.	
④	Teaching protect switch	The teaching button is ineffective if this switch is set on 'LOCK', but is effective if this switch set is on 'SET'.	
⑤	Setting mode selection switch	Manual teaching is selected if the switch is set on 'MANUAL'. Auto-teaching is selected if the switch is set on 'AUTO'.	
⑥	Output operation mode switch	Coincident-ON is selected if the switch is set on 'NORMAL'. Incoincident-ON is selected if the switch is set on 'INVERSE'.	
⑦	Timer operation mode switch	The approx. 40 ms fixed OFF-delay timer is ineffective if this switch is set on 'NON', but is effective if this switch is set on 'OFD'.	
⑧	Tolerance adjuster	Determines the tolerance of equivalence with respect to the reference color, that the sensor has been taught, in 16 grades.	
⑨	Teaching button	Teaches the sensor the reference color as the criterion. (While the button is held, the sensor emits blue, red, and green beams one after the other.)	

Others

- Do not use during the initial transient time (0.5 sec.) after the power supply is switched on.
- Periodical teaching should be done to maintain stable sensing condition.

Fiber Selection

FX-301

FX-302

FX-303

FX-CH

FX-311

FX-11A

FZ-10

PRECAUTIONS FOR PROPER USE

Refer to p.1135~ for general precautions.

Amplifier

Setting

- During teaching, the **FZ-10** series resolves the color projected by the spot into red, green, and blue components which are processed as numerical values and stored into the EEPROM memory. If, during teaching, the spot area is not filled by one uniform color, such as when the target objects are smaller than the spot area, or are partly projected upon, then colors other than the one you want to detect may also be sensed. Make sure that objects fill the whole spot area during teaching, as well as, sensing.
- The taught data is saved in the EEPROM even when the sensor power supply is switched off. However, the guaranteed rewrite operations are limited to 100,000 times because of its lifetime.
- To manipulate the DIP switches, use a pair of tweezers, etc., with a tip width of 0.8 mm 0.031 in approx.

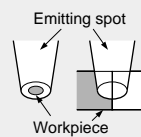

• Procedure

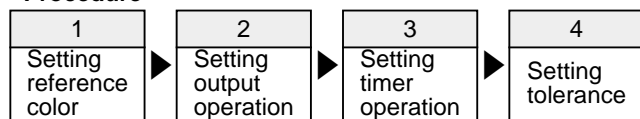

1. Setting reference color

- Prepare a sample object bearing the target color you want to detect. Choose manual teaching or auto-teaching.

Setting by manual-teaching

- Teaching the reference color on a stationary object.

Step	Operation
①	Set the tolerance adjuster at the 16th grade (▲ mark) with the adjusting screwdriver.
②	Set the teaching protect switch on 'SET'.
③	Set the setting mode selection switch on 'MANUAL'.
④	Place the sample object, bearing the reference color, under the fiber head at the setting distance. The surface of the sample object must face the fiber head at right angle to the beam axis, and the reference color must fill the whole spot area. Press the teaching button and release it. Then, the sensor recognizes the reference color as the criterion and starts sensing. <div style="display: flex; justify-content: space-around;"> <div style="border: 1px solid black; padding: 5px;"> <p>Setting distance L FD-L51: 20 mm 0.787 in FD-L52: 10 mm 0.394 in FD-L53: 5 mm 0.197 in FD-L54: 40 mm 1.575 in</p> </div> <div> </div> </div> <p>※ If the teaching fails, the operation indicator (red) and the power indicator (green) blink alternately. Repeat the teaching operation after confirming that the light spot is projected at right angle to the reference color sample and that the distance to the sample is appropriate.</p>
⑤	Set the teaching protect switch on 'LOCK'. ※ After the teaching, test the sensing. If the sensor identifies other similar colors that you do not want to detect, set the tolerance to be finer. (Refer to '4. Setting tolerance' on p.189 for more details.)

Setting by auto-teaching

- Teaching the reference color on a moving object.

- If the sample object includes colors other than the reference color, perform manual teaching. The sample object must contain only one uniform color for correct auto-teaching.

Step	Operation
①	Set the tolerance adjuster at the 16th grade (▲ mark) with the adjusting screwdriver.
②	Set the teaching protect switch on 'SET'.
③	Set the setting mode selection switch on 'AUTO'.
④	Press the teaching button and release it. Then, the sensor enters into the waiting state. (The sensor recognizes the background color, then enters into the waiting state and the power indicator (green) starts blinking.)
⑤	Run the sample object at the setting distance. <ul style="list-style-type: none"> • The sensor recognizes the first coming color other than the background color as the criterion. • The traveling speed must satisfy the following two conditions. <ul style="list-style-type: none"> (1) It should be 300 mm/sec. or more. (2) The reference color must be exposed to the spot for 3 ms or more. • After the sample object moves away, the sensor takes 50 ms approx. to complete the teaching. The sensor is not operable in this period. • The sensor automatically starts sensing after recognizing the reference color as the criterion, and the power indicator (green) stops blinking and lights up continuously. <div style="display: flex; justify-content: space-around;"> <div> </div> <div style="border: 1px solid black; padding: 5px;"> <p>Setting distance L FD-L51: 20 mm 0.787 in FD-L52: 10 mm 0.394 in FD-L53: 5 mm 0.197 in FD-L54: 40 mm 1.575 in</p> </div> </div> <p>※ If the teaching fails, the power indicator (green) keeps blinking. The sensor still stays in the waiting state. Make sure of the perpendicularity of the sample object to the beam axis, the setting distance between the fiber head and the sample, the time duration for which the sample passes through the beam, and the consistency of the background color during the teaching. Then, run the sample object again.</p> <p>※ If your reference color is similar to the background color, the teaching may fail if the tolerance is set at the 16th grade (▲ mark). Make the tolerance of the background color narrower with the tolerance adjuster from the 1st to the 15th grade according to the contrast between these colors. Then, run the sample object again. (Refer to '4. Setting tolerance' on p.189 for more details.)</p>
⑥	Set the teaching protect switch on 'LOCK'.



PRECAUTIONS FOR PROPER USE

Refer to [p.1135](#)~ for general precautions.

Amplifier

2. Setting output operation





- Either Coincident-ON or Incoincident-ON can be selected.

Output operation	Operation	Output operation mode switch
Coincident-ON	Set the output operation mode switch on 'NORMAL'.	INVERSE  NORMAL
Incoincident-ON	Set the output operation mode switch on 'INVERSE'.	INVERSE  NORMAL

3. Setting timer operation

- The **FZ-10** series is incorporated with an OFF-delay timer fixed for 40 ms approx. The OFF-delay timer operates when the timer operation mode switch is set on 'OFD'. Since the output signal is extended by a fixed time interval, this function is useful when the connected device has a slow response time or if small objects are being detected, resulting in a short output signal width.

Time chart

Timer operation mode switch	Sensing condition		Sensing condition
	Operation	Output	
 OFD  NON	Normal	Coincident-ON	ON
		Incoincident-ON	ON
 OFD  NON	Timer	Coincident-ON	ON OFF (T)
		Incoincident-ON	ON OFF (T)

Timer period: T = 40 ms approx.

4. Setting tolerance

- The tolerance adjuster determines the tolerance of equivalence with respect to the reference color in 16 grades.
- Set the arrow mark of the adjuster to the desired grade from 1st to 16th using the adjusting screwdriver.

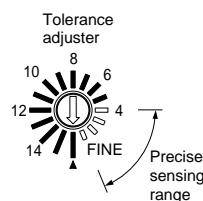

- When the grade is changed, the output is turned ON, once, for resetting.
- Even if the grade is changed, the reference color taught earlier does not change until the sensor is taught again.
- When performing auto-teaching, it is possible that teaching may fail depending upon the tolerance grade. If this happens, change the tolerance grade and repeat the teaching.
- For 16th to 5th grade, color identification is done based upon the color (red, green, blue) component ratio. For 4th to 1th grade (precise range), brightness is also considered for color identification. Hence, when the adjuster is set to the FINE side (4th to 1th grade), minute differences in gloss or color shades are also detected.

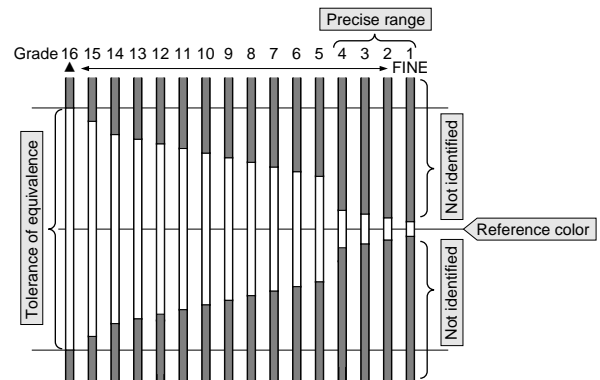

Tolerance in precise range (4th to 1st grade)

- Within the precise range, color is identified in all aspects of hue, chroma, and lightness. Hence, the sensor can discriminate the reference color from others even if there is a subtle difference in glossiness or density.
- After the tolerance is set within the precise range, the sensor should be used under an ambient temperature of +15 to +35 °C +59 to +95 °F. Also, periodical teaching should be done to maintain the stable sensing conditions. Before teaching, wait for a warm-up time of 10 min. approx. after switching on the power supply.
- Please take care that extraneous light or vibration may affect the detectability.

Fiber

Mounting

- Mount with two M3 screws with a tightening torque of 0.5 N·m or less.

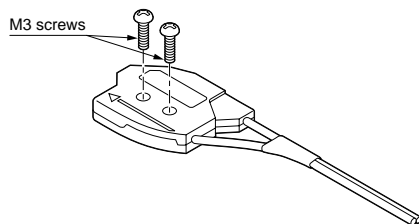

- Several fiber heads of **FD-L51**, **FD-L52**, **FD-L53** and **FD-L54** can be mounted close together as long as their emitted spots do not overlap.

Others

- If the bending radius is smaller than the allowable value, the sensing performance may deteriorate.
- Wipe dirt or stains from the sensing faces with a soft cloth. Do not use any organic solvent for cleaning.
- Ensure that any strong extraneous light is not incident on the receiving face of the fiber head.
- Do not move or bend the fiber cable after the sensitivity setting. Detection may become unstable.
- Keep the fiber head surface intact. If it is scratched or spoiled, the detectability will deteriorate.
- Do not expose the fiber cable to any organic solvents.
- Ensure that the fiber head is not directly exposed to water. A water drop on the fiber head deteriorates the sensing.
- Do not apply excessive tensile force to the fiber cable.

FZ-10

DIMENSIONS (Unit: mm in) The CAD data in the dimensions can be downloaded from the SUNX website: <http://www.sunx.co.jp/>

**FZ-11
FZ-11P** Amplifier

Assembly dimensions with attached amplifier mounting bracket

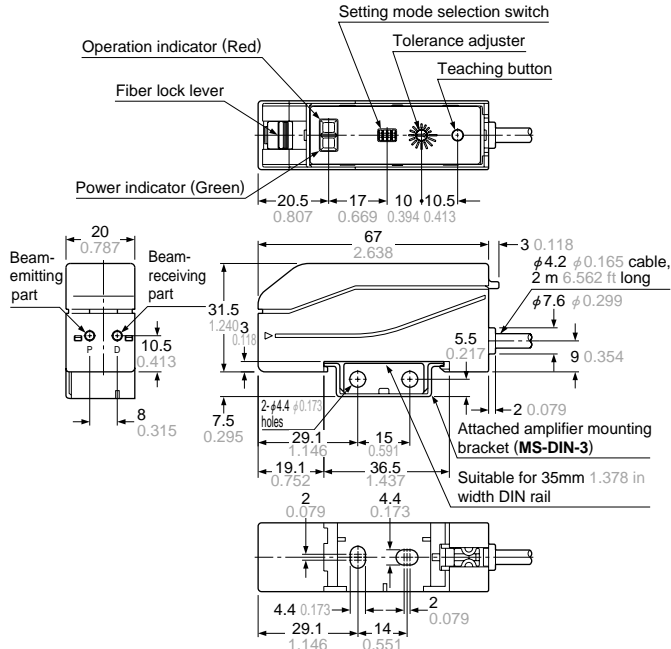

MS-DIN-3 Amplifier mounting bracket
(Accessory for FZ-11□)

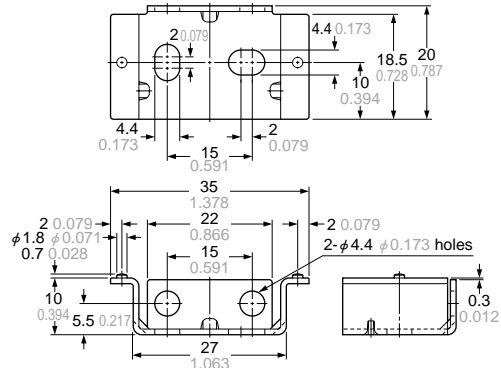

Note: The top view is shown without the cover.

FD-L51 Fiber

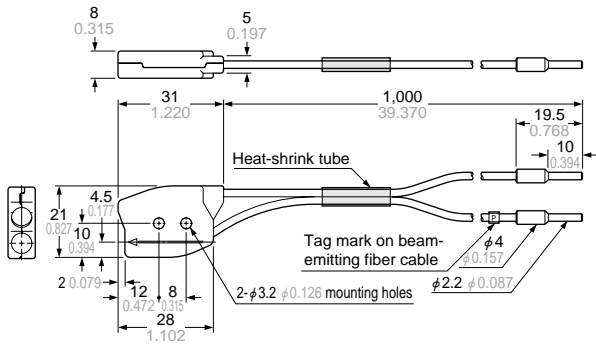

FD-L52 Fiber

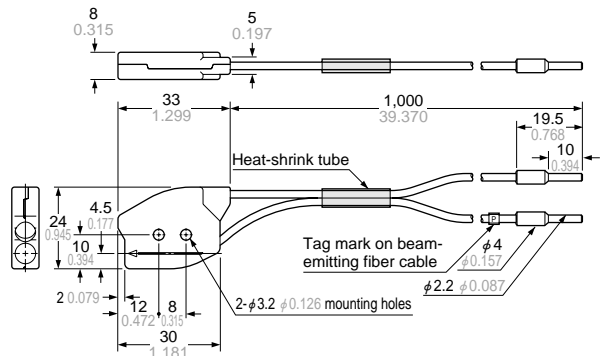

FD-L53 Fiber

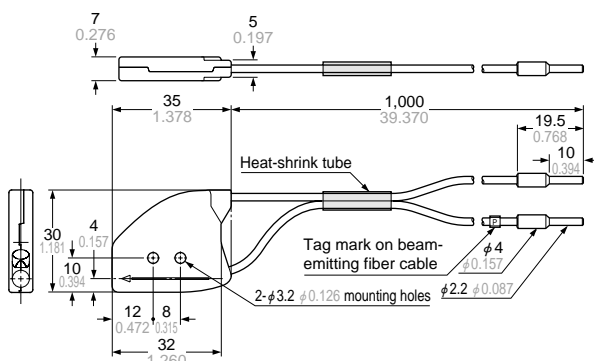

FD-L54 Fiber

