



Current Transformers

SymCom offers a wide array of current transformers.

Voltage class: 600V

BIL rating: 10kV

Available Models:

- CT-50-D-10
- CT-75-D-10
- CT-100-D-10
- CT-150-D-10
- CT-200-D-10
- CT-300-D-10
- CT-100-D-20
- CT-200-D-20
- CT-300-D-20
- CT-400-D-20
- CT-500-D-20
- CT-600-D-20
- CT-300-D-30
- CT-600-D-30

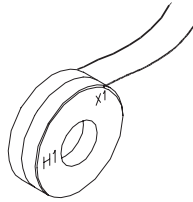

2RL

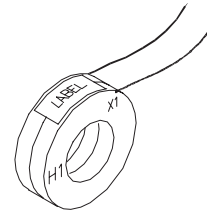
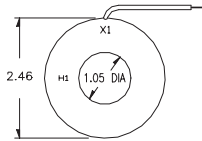
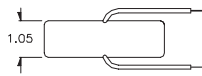

56RL

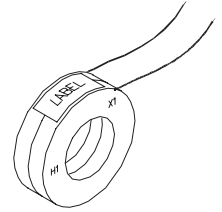
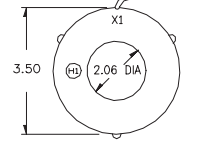
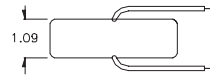

76RL

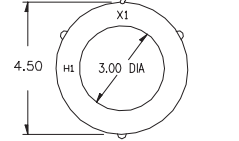
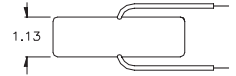

CT-xxx (xxx:5 current ratio)

-D/F (D-Donut Style, F-Footed Style)

-10/20/30 (10-1.0" window; 20-2.0" window; 30-3.0" window)



Available Models:

- CT-50-F-10
- CT-75-F-10
- CT-100-F-10
- CT-150-F-10
- CT-200-F-10
- CT-300-F-10
- CT-150-F-20
- CT-200-F-20
- CT-300-F-20
- CT-400-F-20
- CT-500-F-20
- CT-600-F-20
- CT-1200-F-20
- CT-300-F-30
- CT-400-F-30
- CT-500-F-30
- CT-600-F-30
- CT-800-F-30

BRASS TERMINALS WITH MOUNTING FEET

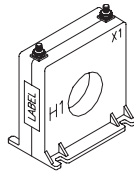

2SFT

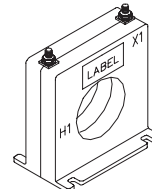
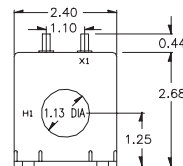
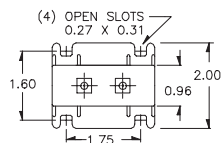

56SFT

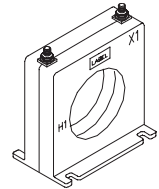
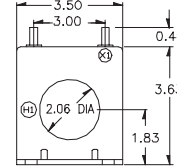
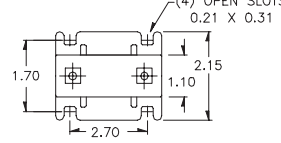

76SFT

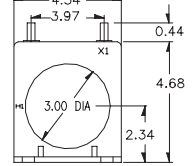
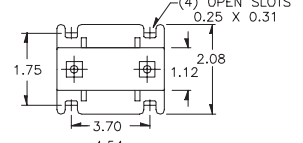

Other styles available. Please call for assistance.