

## DeviceNet™, Thin Cable Specifications

- Cable that Meets the Requirements of ODVA Thin or Type 1 Cable
- Commonly Used as Drop Cable to a Maximum Length of 6 Meters (20 Feet) or Trunk Cable in Networks Up to a Maximum Length of 100 Meters (328 Feet)

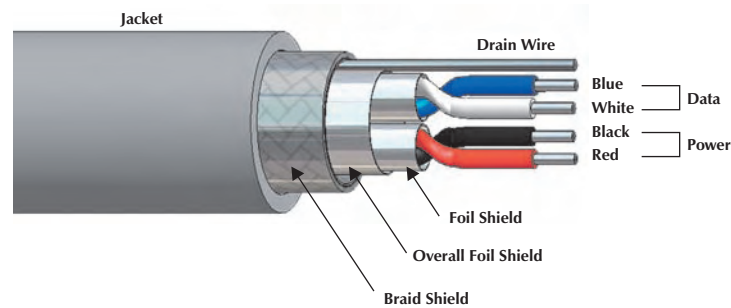

Data Rate	Maximum Trunk Length	Drop Length	
		Maximum	Cumulative
125 Kbaud	100 meters (328 feet)	6 meters (20 feet)	156 meters (512 feet)
250 Kbaud	100 meters (328 feet)		78 meters (feet)
500 Kbaud	100 meters (328 feet)		39 meters (feet)

Type	Approvals	Power Pair		Data Pair		Outer Jacket Material Color Nominal O.D.	Shields Type Drain Wire	Bulk Cable Part Number / Weight/300 M
		AWG Color Code	DCR (/1000 feet) Insulation	AWG Color Code	DCR (/1000 feet) Insulation			
<b>572</b> AWM 2464 75°C 300 Volts	NEC PLTC CEC AWM-I/II A/B FT4	2/22 AWG BK/RD	18.1 Ohms PVC	2/22 AWG BU/WH	18.1 Ohms PE	PVC Light Grey 7.2 mm (.285 in)	Foil 22 AWG	RB50603-*M 44 lbs.
<b>577</b> AWM 2464 75°C 300 Volts	NEC PLTC CEC AWM-I/II A/B FT4	2/22 AWG BK/RD	16.9 Ohms PVC	2/22 AWG BU/WH	16.9 Ohms PE	PVC Light Grey 8.4 mm (.330 in)	Foil/Braid 22 AWG	RB50629-*M 65 lbs. <i>flexlife-10</i> ® †
<b>578</b> AWM 2464 75°C 300 Volts	NEC PLTC/CL2 CEC CMG	2/22 AWG BK/RD	18.1 Ohms PVC	2/22 AWG BU/WH	18.1 Ohms PE	PVC Light Grey 7.8 mm (.310 in)	Foil/Braid 22 AWG	RB50651-*M 51 lbs.
<b>5715</b> AWM 2095 80°C 300 Volts	NEC AWM CEC AWM-I/II A/B FT1	2/22 AWG BK/RD	16.5 Ohms PVC	2/22 AWG BU/WH	16.5 Ohms PE	PVC Light Grey 6.0 mm (.235 in)	Foil (Data Only) 22 AWG	RB50764-*M 26 lbs.
<b>5725</b> AWM 21080 75°C 300 Volts	NEC AWM	2/22 AWG BK/RD	16.5 Ohms PE	2/24 AWG BU/WH	27.7 Ohms PE	PUR Violet 7.1 mm (.280 in)	Foil/Braid 22 AWG	RB50994-*M 50 lbs. <b>Halogen-Free</b> ††
<b>5732</b> AWM 20626 80°C 600 Volts	NEC AWM CEC AWM-I/II A/B FT4	2/22 AWG BK/RD	16.5 Ohms PVC	2/22 AWG BU/WH	16.5 Ohms PE	TPE Charcoal Grey 9.3 mm (.365 in)	Foil/Braid 22 AWG	RB51296-*M 68 lbs. <i>flexlife</i> ® † <i>weldlife</i> ™ †

\* Indicates length in meters.

Standard cable lengths are 1, 2, 4, 5, 6, 8, 10, 15, and in +5 meter increments from there. Consult factory for other lengths.

† See page A7 for *flexlife*® performance.

†† Zero Halogen: to DIN VDE 0472 part 815 + IEC 60754-1

# TURCK

## Network Media Products

### DeviceNet™, Mid Cable Specifications

- Cable That Meets the Requirements of ODVA Mid or Type III Cable
- Provides More Flexibility When Used as a Trunk Cable Up to a Maximum Length of 300 Meters (984 Feet)

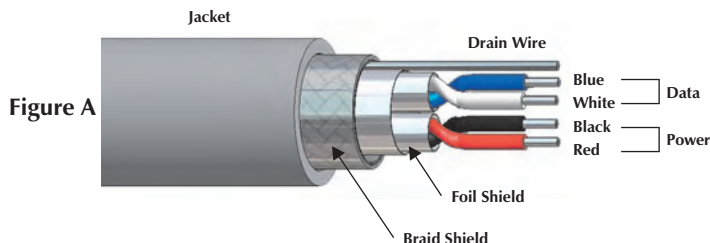

Figure A

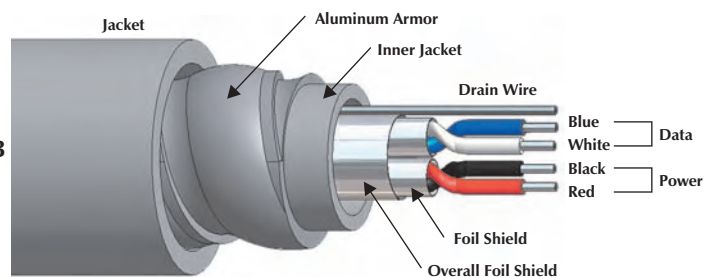

Figure B

Data Rate	Maximum Trunk Length
125 Kbaud	300 meters (984 feet)
250 Kbaud	250 meters (820 feet)
500 Kbaud	100 meters (328 feet)

Type	Approvals	Power Pair		Data Pair		Outer Jacket	Shields	Bulk Cable Part Number / Weight/300 M	Figure
		AWG Color Code	DCR (/1000 feet) Insulation	AWG Color Code	DCR (/1000 feet) Insulation	Material Color Nominal O.D.	Type Drain Wire		
<b>5711</b> AWM 2464 80°C 300 Volts	NEC PLTC CEC AWM-I/II A/B FT4	2/16 AWG BK/RD	4.1 Ohms PVC	2/20 AWG BU/WH	11.2 Ohms PE	PVC Light Grey 8.4 mm (.330 in)	Foil 20 AWG	RB50721-*M 65 lbs.	A
<b>5722</b> AWM 2464 75°C 300 Volts	NEC PLTC CEC AWM-I/II A/B FT4	2/17 AWG BK/RD	5.2 Ohms SR-PVC	2/20 AWG BU/WH	10.4 Ohms PE	PVC Light Grey 8.9 mm (.350 in)	Foil 20 AWG	RB50876-*M 71 lbs. <i>flexlife-10</i> ® †	A
<b>5723</b> AWM 20233 80°C 300 Volts	NEC AWM CEC AWM-I/II A/B FT1	2/17 AWG BK/RD	5.2 Ohms PVC	2/20 AWG BU/WH	10.4 Ohms PE	PUR Light Grey 8.4 mm (.330 in)	Foil 20 AWG	RB50877-*M 60 lbs. <i>flexlife-10</i> †	A
<b>5721A</b> 75°C 300 Volts	NEC PLTC/CM CEC CMG HL ABCD	2/18 AWG BK/RD	6.7 Ohms PVC	2/20 AWG BU/WH	10.4 Ohms PE	PVC Light Grey 14.9 mm (.585 in) Aluminum Armor	Foil/Armor 20 AWG	RB50859-*M 101 lbs. <i>armorfast</i> ®	B
<b>5731</b> AWM 20626 80°C 300 Volts	NEC AWM CEC AWM-I/II A/B FT1	2/16 AWG BK/RD	4.1 Ohms PVC	2/20 AWG BU/WH	10.4 Ohms PE	TPE Charcoal Grey 10 mm (.394 in)	Foil/Spiral None	RB51235-*M 95 lbs. <i>flexlife</i> † <i>weldlife</i> ™ †	A

\* Indicates length in meters.

Standard cable lengths are 1, 2, 4, 5, 6, 8, 10, 15, and in +5 meter increments from there. Consult factory for other lengths.

† See page A7 for *flexlife*® and *weldlife*™ performance.

## DeviceNet™, Thick Cable Specifications

- Cable That Meets the Requirements of ODVA Thick or Type II Cable
- It Provides the Most Power to a Network When Used as a Trunk Cable Up to a Maximum Standard Cable Length of 500 Meters (1640 Feet)

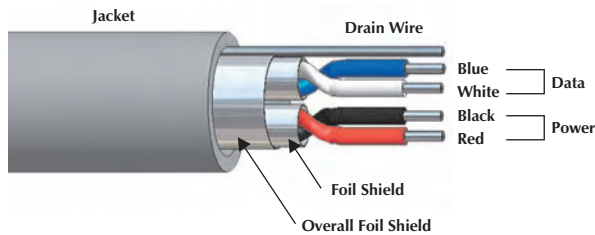

Data Rate	Maximum Trunk Length	Maximum Trunk Length (5720)
125 Kbaud	500 meters (1640 feet)	420 meters (1378 feet)
250 Kbaud	250 meters (820 feet)	200 meters (656 feet)
500 Kbaud	100 meters (328 feet)	100 meters (328 feet)













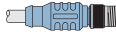

Type	Approvals	Power Pair		Data Pair		Outer Jacket	Shields	Bulk Cable Part Number / Weight/300 M
		AWG Color Code	DCR (/1000 feet) Insulation	AWG Color Code	DCR (/1000 feet) Insulation			
<b>575</b> AWM 20233 80°C 300 Volts	NEC AWM CEC AWM-I/II A/B FT1	2/15 AWG BK/RD	3.3 Ohms PVC	2/18 AWG BU/WH	6.5 Ohms PE	PUR Light Grey 10.4 mm (.409 in)	Foil/Braid 18 AWG	RB50633-*M 94 lbs.
<b>579</b> AWM 2570 75°C 300 Volts	NEC PLTC/CL2 CEC CMG	2/15 AWG BK/RD	3.2 Ohms PVC	2/18 AWG BU/WH	6.5 Ohms PE	PVC Light Grey 11.3 mm (.445 in)	Foil/Braid 18 AWG	RB50652-*M 122 lbs.
<b>5720</b> 75°C 600 Volts	NEC TC	2/16 AWG BK/RD	4.9 Ohms PVC	2/18 AWG BU/WH	6.9 Ohms PE	PVC Light Grey 13 mm (.515 in)	Foil/Braid 16 AWG	RB50793-*M 168 lbs.
<b>5726</b> AWM 21080 70°C 300 Volts	NEC AWM	2/15 AWG BK/RD	3.2 Ohms PE	2/18 AWG BU/WH	6.9 Ohms PE	PUR Violet 11.2 mm (.449 in)	Foil/Braid 18 AWG	RB51038-*M 150 lbs. <b>Halogen-Free</b> ††
<b>5727</b> 75°C 300 Volts	NEC PLTC CEC AWM-I/II A/B FT4	2/15 AWG BK/RD	3.44 Ohms PVC	2/18 AWG BU/WH	7.06 Ohms PE	PVC Light Grey 13.7 mm (.540 in)	Foil/Spiral None	RB51106-*M 157 lbs <b>flexlife-10</b> ® †
<b>5730</b> AWM 20626 80°C 300 Volts	NEC AWM CEC AWM-I/II A/B FT1	2/15 AWG BK/RD	3.44 Ohms PVC	2/18 AWG BU/WH	7.06 Ohms PE	TPE Grey 10.4 mm (.413 in)	Foil/Braid 18 AWG	RB51231-*M 110 lbs. <b>flexlife</b> † <b>weldlife</b> ™ †

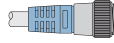
\* Indicates length in meters.  
 Standard cable lengths are 1, 2, 4, 5, 6, 8, 10, 15, and in +5 meter increments from there. Consult factory for other lengths.†  
 See page A7 for **flexlife**® and **weldlife** performance.  
 †† Zero Halogen: to DIN VDE 0472 part 815 + IEC 60754-1

# TURCK

## Network Media Products

### DeviceNet™, Cable/Cordset Selection Matrix

		<i>minifast</i> ®				<i>eurofast</i> ® (Thin/Mid Only)	
		Pin (Male)		Socket (Female)		Pin (Male)	
		1  RSM	2  WSM	3  RKM	4  WKM	5  RSC	
 Bare		RSM 57x-*M	WSM 57x-*M	RKM 57x-*M	WKM 57x-*M	RSC 57x-*M	
<i>minifast</i>	Pin (Male)	1  RSM	RSM RSM 57x-*M	RSM WSM 57x-*M	RSM RKM 57x-*M	RSM WKM 57x-*M	RSM RSC 57x-*M
	2  WSM		WSM WSM 57x-*M	WSM RKM 57x-*M	WSM WKM 57x-*M	WSM RSC 57x-*M	
	3  RKM			RKM RKM 57x-*M	RKM WKM 57x-*M	RKM RSC 57x-*M	
	4  WKM				WKM WKM 57x-*M	WKM RSC 57x-*M	
<i>eurofast (Thin/Mid Only)</i>	5  RSC					RSC RSC 57x-*M	
	6  WSC						
	7  RKC						
	8  WKC						

See pages G11 - G12 for dimensional drawings.

\* Indicates length in meters.

x Indicates cable type.



Refer to the Cordset Builder at [www.turck.com](http://www.turck.com) for assistance with cordset/cable combinations.

Standard cable lengths are 1, 2, 4, 5, 6, 8, 10, 15, and in +5 meter increments from there. Consult factory for other lengths.

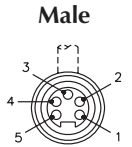
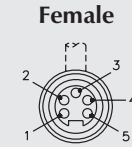
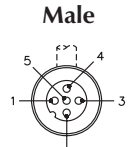
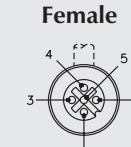
For stainless steel coupling nuts change part number RSM ... to RSV, WSM ... to WSV.

<i>minifast</i>		Pinouts	<i>eurofast</i>	
<b>Male</b> 	<b>Female</b> 	1. Bare (Shield Drain Wire) 2. Red (+ Voltage) 3. Black (- Voltage) 4. White (CAN_H) 5. Blue (CAN_L)	<b>Male</b> 	<b>Female</b> 

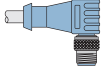
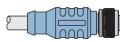
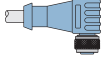
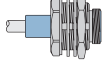
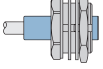
## DeviceNet™, Cable/Cordset Selection Matrix

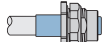





eurofast® (Thin/Mid Only)			minifast® Bulkhead		eurofast Bulkhead (Thin Only)	
Pin (Male)	Socket (Female)		Pin (Male)	Socket (Female)	Pin (Male)	Socket (Female)
6 	7 	8 	9 	10 	11 	12 
WSC	RKC	WKC	RSFP	RKFP	FSFD	FKFD
WSC 57x-*M	RKC 57x-*M	WKC 57x-*M	RSFP 57x-*M	RKFP 57x-*M	FSFD 57x-*M	FKFD 57x-*M
RSM WSC 57x-*M	RSM RKC 57x-*M	RSM WKC 57x-*M	RSM RSFP 57x-*M	RSM RKFP 57x-*M	RSM FSFD 57x-*M	RSM FKFD 57x-*M
WSM WSC 57x-*M	WSM RKC 57x-*M	WSM WKC 57x-*M	WSM RSFP 57x-*M	WSM RKFP 57x-*M	WSM FSFD 57x-*M	WSM FKFD 57x-*M
RKM WSC 57x-*M	RKM RKC 57x-*M	RKM WKC 57x-*M	RKM RSFP 57x-*M	RKM RKFP 57x-*M	RKM FSFD 57x-*M	RKM FKFD 57x-*M
WKM WSC 57x-*M	WKM RKC 57x-*M	WKM WKC 57x-*M	WKM RSFP 57x-*M	WKM RKFP 57x-*M	WKM FSFD 57x-*M	WKM FKFD 57x-*M
RSC WSC 57x-*M	RSC RKC 57x-*M	RSC WKC 57x-*M	RSC RSFP 57x-*M	RSC RKFP 57x-*M	RSC FSFD 57x-*M	RSC FKFD 57x-*M
WSC WSC 57x-*M	WSC RKC 57x-*M	WSC WKC 57x-*M	WSC RSFP 57x-*M	WSC RKFP 57x-*M	WSC FSFD 57x-*M	WSC FKFD 57x-*M
	RKC RKC 57x-*M	RKC WKC 57x-*M	RKC RSFP 57x-*M	RKC RKFP 57x-*M	RKC FSFD 57x-*M	RKC FKFD 57x-*M
		WKC WKC 57x-*M	WKC RSFP 57x-*M	WKC RKFP 57x-*M	WKC FSFD 57x-*M	WKC FKFD 57x-*M

DeviceNet Media

# TURCK

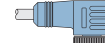
## Network Media Products

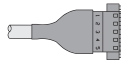
### DeviceNet™, Open Connector Cordset Selection Matrix

		<i>minifast</i> ®				<i>eurofast</i> ®
		Pin (Male)		Socket (Female)		Pin (Male)
		1  RSM	2  WSM	3  RKM	4  WKM	5  RSC
13  CBC5	CBC5 57x-*M	RSM CBC5 57x-*M	WSM CBC5 57x-*M	RKM CBC5 57x-*M	WKM CBC5 57x-*M	RSC CBC5 57x-*M
14  BK52C	BK52C 57x-*M	RSM BK52C 57x-*M	WSM BK52C 57x-*M	RKM BK52C 57x-*M	WKM BK52C 57x-*M	RSC BK52C 57x-*M
Thin, Mid and Thick Cable						Thin Cable Only

See pages G10 - G12 for dimensional drawings.

\* Indicates length in meters.

x Indicates cable type.

Refer to the Cordset Builder at [www.turck.com](http://www.turck.com) for assistance with cordset/cable combinations.

Standard cable lengths are 1, 2, 4, 5, 6, 8, 10, 15, and in +5 meter increments from there. Consult factory for other lengths.

For stainless steel coupling nut: Change part number (RSM ... to RSV, RSC ... to RSCV).

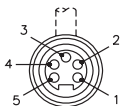
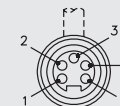
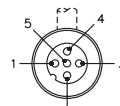
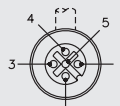
<i>minifast</i>		Pinouts	<i>eurofast</i>	
<b>Male</b> 	<b>Female</b> 	1. Bare (Shield Drain Wire) 2. Red (+ Voltage) 3. Black (- Voltage) 4. White (CAN_H) 5. Blue (CAN_L)	<b>Male</b> 	<b>Female</b> 

**DeviceNet™, Open Connector Cordset Selection Matrix**

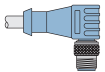
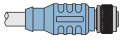
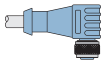
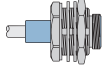
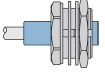
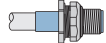
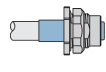
eurofast®			minifast® Bulkhead		eurofast Bulkhead	
Pin (Male)	Socket (Female)		Pin (Male)	Socket (Female)	Pin (Male)	Socket (Female)
6 	7 	8 	9 	10 	11 	12 
WSC	RKC	WKC	RSFP	RKFP	FSFD	FKFD
WSC CBC5 57x-*M	RKC CBC5 57x-*M	WKC CBC5 57x-*M	RSFP CBC5 57x-*M	RKFP CBC5 57x-*M	FSFD CBC5 57x-*M	FKFD CBC5 57x-*M
WSC BK52C 57x-*M	RKC BK52C 57x-*M	WKC BK52C 57x-*M	RSFP BK52C 57x-*M	RKFP BK52C 57x-*M	FSFD BK52C 57x-*M	FKFD BK52C 57x-*M
Thin and Mid Cable Only			Thin, Mid and Thick Cable		Thin Cable Only	

DeviceNet Media

See pages G11 - G12 for dimensional drawings.

\* Indicates length in meters.

x Indicates cable type.

Refer to the Cordset Builder at [www.turck.com](http://www.turck.com) for assistance with cordset/cable combinations.

Standard cable lengths are 1, 2, 4, 5, 6, 8, 10, 15, and in +5 meter increments from there. Consult factory for other lengths.

**Specifications**

- Housing:** PA (Nylon)
- Protection:** NEMA 1, and IEC IP 20
- Rated Voltage:** 250 V
- Rated Current:** 12 A
- Ambient Temperature:** -40° to +75°C (-22° to +167°F)

13

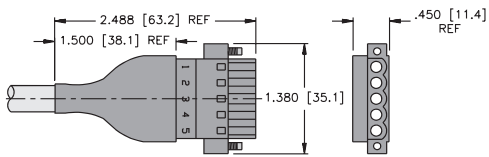

CBC5 ..

Page G9

14

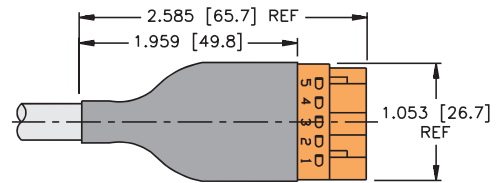

BK52C ..

Page G9

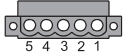
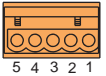
CBC5	Pinouts	BK52C
	1 = Black (- Voltage) 2 = Blue (CAN_L) 3 = Bare (Shield Drain) 4 = White (CAN_H) 5 = Red (+ Voltage)	

**Specifications**

<b>Overmold:</b>	PUR (Polyurethane)
<b>Coupling Nut:</b>	Nickel Plated CuZn or Stainless Steel
<b>Contact Carrier:</b>	PUR (Polyurethane)
<b>Contacts:</b>	Gold Plated CuZn
<b>Protection:</b>	NEMA 1, 3, 4, 6P and IEC IP 67
<b>Rated Voltage:</b>	300 V
<b>Rated Current:</b>	9 A
<b>Ambient Temperature:</b>	-40° to +75°C (-22° to +167°F)

1

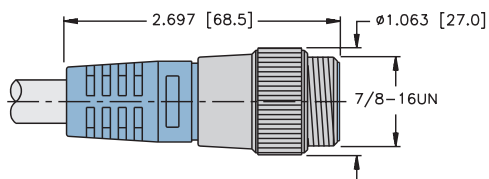

RSM ..

Pages G7 - G10

3

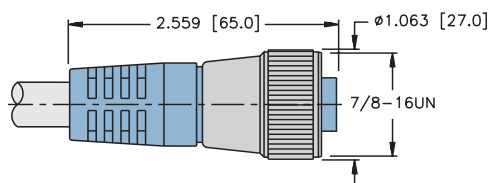

RKM ..

Pages G7 - G10

2

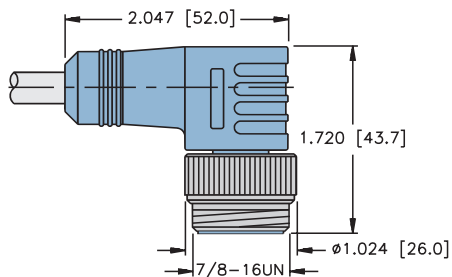

WSM ..

Pages G7 - G10

4

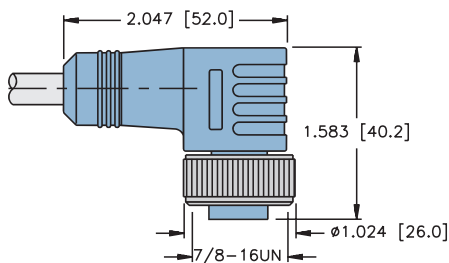

WKM ..

Pages G7 - G10

9

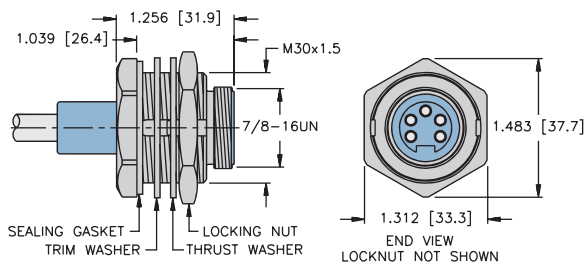

RSNP ..

Pages G7 - G10

10

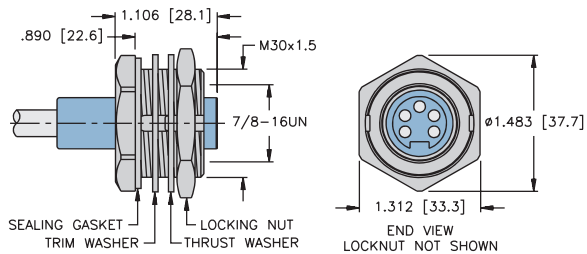

RKFP ..

Pages G7 - G10

**DeviceNet™, eurofast® Cordset and Receptacle Connector Dimensions**

**Specifications**

<b>Overmold:</b>	PUR (Polyurethane)
<b>Coupling Nut:</b>	Nickel Plated CuZn or Stainless Steel
<b>Contact Carrier:</b>	PUR (Polyurethane) or POM (Nylon)
<b>Contacts:</b>	Gold Plated CuZn
<b>Protection:</b>	NEMA 1, 3, 4, 6P and IEC IP 68
<b>Rated Voltage:</b>	250 V
<b>Rated Current:</b>	4 A
<b>Ambient Temperature:</b>	-40° to +75°C (-22° to +167°F)

DeviceNet Media

5

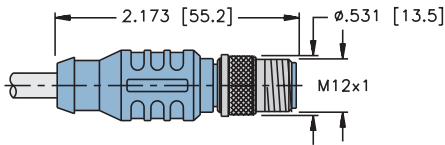

RSC ..

Pages G7 - G10

7

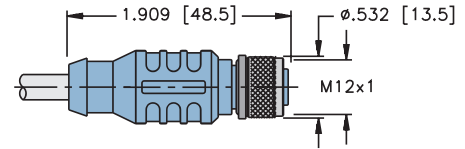

RKC ..

Pages G7 - G10

6

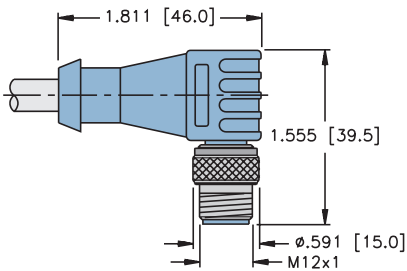

WSC ..

Pages G7 - G10

8

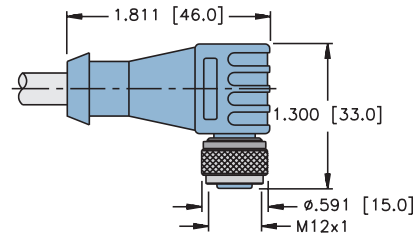

WKC ..

Pages G7 - G10

11

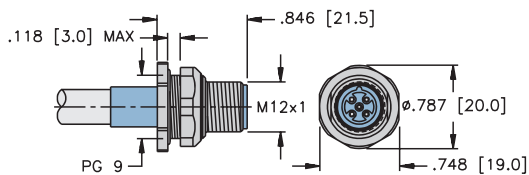

FSFD ..

Pages G7 - G10

12

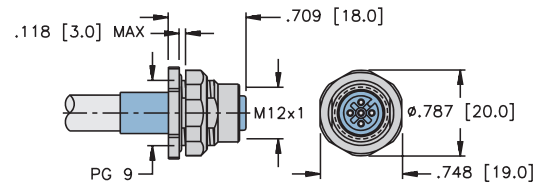

FKFD ..

Pages G7 - G10

# TURCK

## Network Media Products

### DeviceNet™, Flat Cable Specifications

- Cable that Meets the Requirements of ODVA Thick or Type II Cable
- Uses Insulation Displacement Connectors as Device Taps

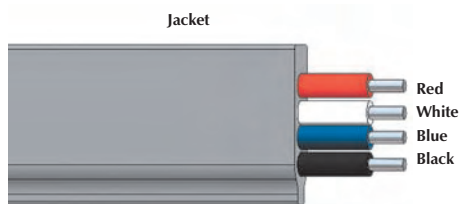

Data Rate	Maximum Trunk Length
125 Kbaud	420 meters (1378 feet)
250 Kbaud	200 meters (656 feet)
500 Kbaud	100 meters (328 feet)

Type	Approvals	Power Pair		Data Pair		Outer Jacket	Shields	Bulk Cable Part Number / Weight/300 M
		AWG Color Code	DCR (/1000 feet) Insulation	AWG Color Code	DCR (/1000 feet) Insulation	Material Color Nominal O.D.	Type Drain Wire	
<b>5713</b> 75°C 300 Volts	NEC CL2 CEC AWM-I/II A/B FT4	2/16 AWG BK/RD	4.1 PE	2/16 AWG BU/WH	4.1 PE	PVC Light Grey Flat Profile <sup>††</sup>	None	RB50787-*M 116 lbs.

\* Indicates length in meters.

Standard cable lengths are 1, 2, 4, 5, 6, 8, 10, 15, and in +5 meter increments from there. Consult factory for other lengths.

†† Flat cable profile is 19.3 mm (0.760 in) x 5.3 mm (0.210 in).

#### Flat Cable Profile

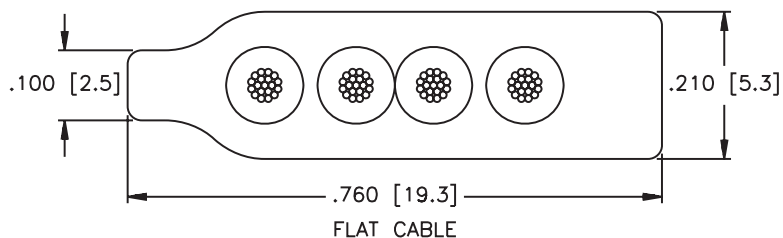

DeviceNet™, Flat Cable Connectors

- Provides a *minifast*® or *eurofast*® Drop Connector from Flat Cable



Housing	Part Number	Application	Pinouts
	<b>RKF 57-DC</b>	(7/8-16UN) <i>minifast</i> Flat Cable Connector <ul style="list-style-type: none"> <li>Flat cable connector to female (7/8-16UN) <i>minifast</i> drop</li> </ul>	<b>Female</b> 
	<b>RKF 40-DC</b>	(7/8-16UN) <i>minifast</i> Auxiliary Power Connector	<b>Female</b> 
	<b>FK 57-DC</b>	(M12x1) <i>eurofast</i> Flat Cable Connector <ul style="list-style-type: none"> <li>Flat cable connector to female (M12x1) <i>eurofast</i> drop</li> </ul>	<b>Female</b> 
	<b>FK 57-DC ET</b>	Includes connector, end termination, and splice kit	
	<b>RKF 57-DC ET</b>		
	<b>RKF 40-DC ET</b>		

DeviceNet Media

Specifications

<b>Housing:</b>	POM (Nylon)
<b>Coupling Nut:</b>	Nickel Plated CuZn or Stainless Steel
<b>Contact Carrier:</b>	Nylon
<b>Contacts:</b>	Gold Plated CuZn
<b>Protection:</b>	NEMA 1, 3, 4, 6P and IEC IP 68
<b>Rated Voltage:</b>	250 V
<b>Rated Current:</b>	4 A ( <i>eurofast</i> ), 9 A ( <i>minifast</i> )
<b>Ambient Temperature:</b>	-40° to +75°C (-22° to +167°F)

## DeviceNet™, Pico Cable Specifications

- Cable that Meets the Electrical Requirements of ODVA Thin Cable (Data Pair Only)
- Pico Cable has 24 AWG Conductors Which May be Used with *picofast*® Connectors
- Submittal to ODVA - Pending

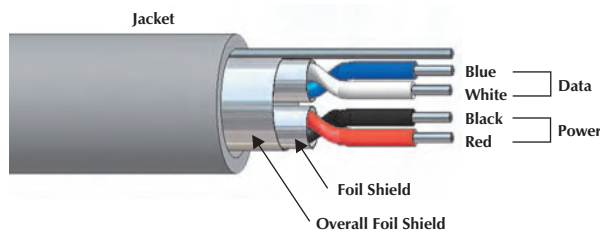

DeviceNet Media

### DeviceNet - Pico Cable 5724

Data Rate	Maximum Trunk Length
125 Kbaud	35 meters (115 feet)
250 Kbaud	35 meters (115 feet)
500 Kbaud	35 meters (115 feet)

### DeviceNet - Thin Cable 5715

Data Rate	Maximum Trunk Length
125 Kbaud	100 meters (984 feet)
250 Kbaud	100 meters (820 feet)
500 Kbaud	100 meters (328 feet)









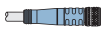
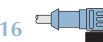

Type	Approvals	Power Pair		Data Pair		Outer Jacket Material Color Nominal O.D.	Shields Type Drain Wire	Bulk Cable Part Number / Weight/300 M
		AWG Color Code	DCR (/1000 feet) Insulation	AWG Color Code	DCR (/1000 feet) Insulation			
<b>5724</b> AWM 2464 80°C 300 Volts	NEC AWM CEC AWM-I/II A/B FT1	2/24 AWG BK/RD	24.9 PVC	2/24 AWG BU/WH	24.9 PE	PVC Light Grey 5.7 mm (.224 in)	Foil (Data Only) 24 AWG	RB51045-*M 27 lbs.
<b>5715</b> AWM 2464 80°C 300 Volts	NEC AWM CEC AWM-I/II A/B FT1	2/22 AWG BK/RD	16.5 PVC	2/22 AWG BU/WH	16.5 PE	PVC Light Grey 6.0 mm (.235 in)	Foil (Data Only) 22 AWG	RB50764-*M 26 lbs.

\* Indicates length in meters.  
Standard cable lengths are 1, 2, 4, 5, 6, 8, 10, 15, and in +5 meter increments from there. Consult factory for other lengths.

# TURCK

## Network Media Products

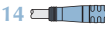
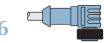
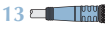
### DeviceNet™, Cable/Cordsets Selection Matrix - Threaded

		picofast® (5724 Cable Only)				eurofast® (5724 Cable Only)			
		Socket (Female)		Pin (Male)					
		14 	16 	13 	15 	19 	21 	20 	22 
		PKGM	PKWM	PSGM	PSWM	RST	WST	RKT	WKT
		PKGM 57x-*M	PKWM 57x-*M	PSGM 57x-*M	PSWM 57x-*M	RST 57x-*	WST 57x-*	RKT 57x-*	WKT 57x-*
<b>picofast (5724 Cable Only)</b>	<b>Socket (Female)</b>								
	14 	PKGM PKGM 57x-*M	PKGM PKWM 57x-*M	PKGM PSGM 57x-*M	PKGM PSWM 57x-*M	PKGM RST 57x-*M	PKGM WST 57x-*M	PKGM RKT 57x-*M	PKGM WKT 57x-*M
	16 		PKWM PKWM 57x-*M	PKWM PSGM 57x-*M	PKWM PSWM 57x-*M	PKWM RST 57x-*M	PKWM WST 57x-*M	PKWM RKT 57x-*M	PKWM WKT 57x-*M
	13 			PSGM PSGM 57x-*M	PSGM PSWM 57x-*M	PSGM RST 57x-*M	PSGM WST 57x-*M	PSGM RKT 57x-*M	PSGM WKT 57x-*M
<b>Pin (Male)</b>									
15 					PSWM PSWM 57x-*M	PSWM RST 57x-*M	PSWM WST 57x-*M	PSWM RKT 57x-*M	PSWM WKT 57x-*M

See pages G19 - G20 for dimensional drawings.

\* Indicates length in meters.

x Indicates cable type. See page B125 for available cable types.

Type 5715 cable can be used with RST, WST, RKT and WKT smaller body styles. Consult factory for part numbers.

Refer to the Cordset Builder at [www.turck.com](http://www.turck.com) for assistance with cordset/cable combinations.

Standard cable lengths are 1, 2, 4, 5, 6, 8, 10, 15, and in +5 meter increments from there. Consult factory for other lengths.

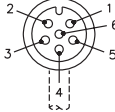
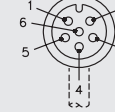
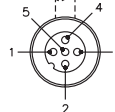
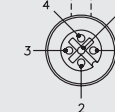
picofast		Pinouts	eurofast	
<b>Male</b>	<b>Female</b>	1. Bare (Shield Drain Wire) 2. Red (+ Voltage) 3. Black (- Voltage) 4. White (CAN_H) 5. Blue (CAN_L) 6. N/C ( <i>picofast</i> only)	<b>Male</b>	<b>Female</b>
				

## DeviceNet™, Cable/Cordsets Selection Matrix - Snap Lock

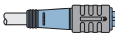
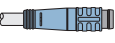
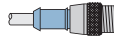
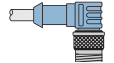
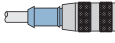
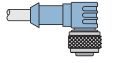
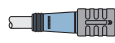
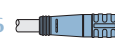
		picofast®		eurofast®				
		Socket (Female)	Pin (Male)					
		18  PKGZ	17  PSG	17  RST	18  WST	19  RKT	20  WKT	
Bare		PKGZ 57x-*M	PSG 57x-*M	RST 57x-*	WST 57x-*	RKT 57x-*	WKT 57x-*	
picofast® (5724 Cable Only)	Socket (Female)	15  PKGZ	PKGZ PKGZ 57x-*M	PKGZ PSG 57x-*M	PKGZ RST 57x-*M	PKGZ WST 57x-*M	PKGZ RKT 57x-*M	PKGZ WKT 57x-*M
	Pin (Male)	16  PSG		PSG PSG 57x-*M	PSG RST 57x-*M	PSG WST 57x-*M	PSG RKT 57x-*M	PSG WKT 57x-*M

DeviceNet Media

See pages G19 - G20 for dimensional drawings.

\* Indicates length in meters.

x Indicates cable type. See page B125 for available cable types.

Type 5715 cable can be used with RST, WST, RKT and WKT smaller body styles. Consult factory for part numbers.

Refer to the Cordset Builder at [www.turck.com](http://www.turck.com) for assistance with cordset/cable combinations.

Standard cable lengths are 1, 2, 4, 5, 6, 8, 10, 15, and in +5 meter increments from there. Consult factory for other lengths.

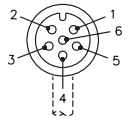
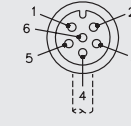
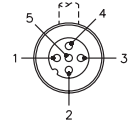
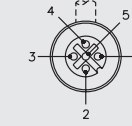
picofast		Pinouts	eurofast	
Male	Female		Male	Female
		<ol style="list-style-type: none"> <li>1. Bare (Shield Drain Wire)</li> <li>2. Red (+ Voltage)</li> <li>3. Black (- Voltage)</li> <li>4. White (CAN_H)</li> <li>5. Blue (CAN_L)</li> <li>6. N/C (<i>picofast</i> only)</li> </ol>		

**Specifications**

<b>Housing:</b>	PUR (Polyurethane)
<b>Coupling Nut:</b>	Nickel Plated CuZn or Stainless Steel
<b>Contact Carrier:</b>	PUR (Polyurethane)
<b>Contacts:</b>	Gold Plated CuZn
<b>Protection:</b>	NEMA 1, 3, 4, 6P and IEC IP 68
<b>Rated Voltage:</b>	250 V
<b>Rated Current:</b>	4 A
<b>Ambient Temperature:</b>	-40° to +75°C (-22° to +167°F)

19

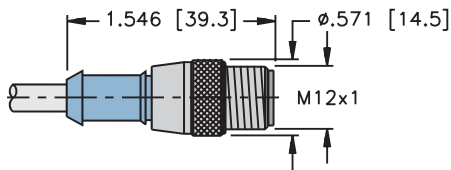

RST ..

Pages G17 - G18

20

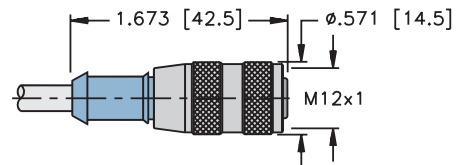

RKT ..

Pages G17 - G18

21

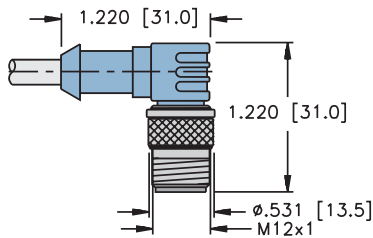

WST ..

Pages G17 - G18

22

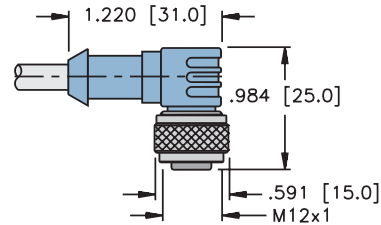

WKT ..

Pages G17 - G18

**DeviceNet™, picofast® Cable/Cordsets Connector Dimensions**

**Specifications**

<b>Housing:</b>	PUR (Polyurethane)
<b>Coupling Nut:</b>	Nickel Plated CuZn or Stainless Steel (thread), Nylon (snap lock)
<b>Contact Carrier:</b>	PUR (Polyurethane) or POM (Nylon)
<b>Contacts:</b>	Gold Plated CuZn
<b>Protection:</b>	NEMA 1, 3, 4, 6P and IEC IP 67
<b>Rated Voltage:</b>	30 V
<b>Rated Current:</b>	1.5 A
<b>Ambient Temperature:</b>	-40° to +75°C (-22° to +167°F)

DeviceNet Media

13

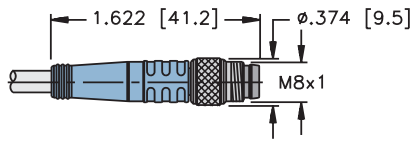

PSGM ..

Pages G17 - G18

14

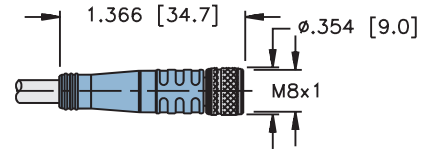

PKGM ..

Pages G17 - G18

15

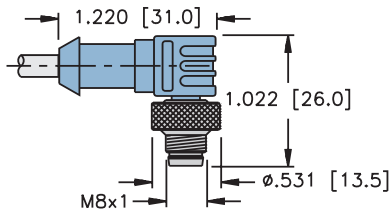

PSWM ..

Pages G17 - G18

16

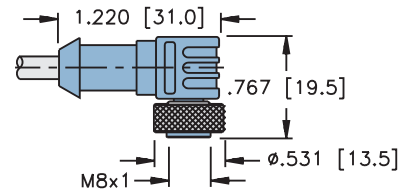

PKWM ..

Pages G17 - G18

17

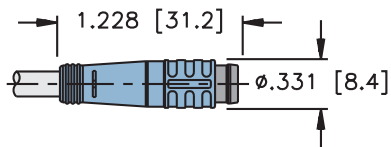

PSG ..

Pages G17 - G18

18

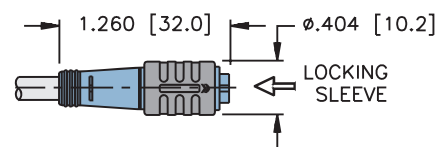

PKGZ ..

Pages G17 - G18

# TURCK

## Network Media Products

### DeviceNet™, Terminating Resistors

- Terminating Resistors Stabilize and Minimize Reflections on the Bus Line
- A Terminating Resistor is Required at the Beginning and End of the Main Bus Line



Housing	Part Number	Specs	Application	Pinouts
	<b>RSM 57-TR2</b>	Nickel Plated Brass or Stainless Steel 300 V, 9 A -40° to +75°C IP 67	<b>minifast</b> ® Terminating Resistor <ul style="list-style-type: none"> <li>• Male <b>minifast</b> connector</li> <li>• 120 Ohms, 1/4 W internal resistance</li> </ul>	<b>Male</b> 
	<b>RSM 57-TR2/VM</b>	Nickel Plated Brass or Stainless Steel 300 V, 9 A -40° to +75°C IP 67	<b>minifast</b> Terminating Resistor with Voltage Monitoring <ul style="list-style-type: none"> <li>• Male <b>minifast</b> connector</li> <li>• Led indication: Red - reverse polarity Green-okay</li> <li>• 120 Ohms, 1/4 W internal resistance</li> </ul>	<b>Male</b> 
	<b>RKM 57-TR2</b>	Nickel Plated Brass or Stainless Steel 250 V, 4 A -40° to +75°C IP 67	<b>minifast</b> Terminating Resistor <ul style="list-style-type: none"> <li>• Female <b>minifast</b> connector</li> <li>• 120 Ohms, 1/4 W internal resistance</li> </ul>	<b>Female</b> 
	<b>RSE 57-TR2</b>	Nickel Plated CuZn or Stainless Steel 250 V, 4 A -40° to +75°C IP 67	<b>eurofast</b> ® Terminating Resistor <ul style="list-style-type: none"> <li>• Male <b>eurofast</b> connector</li> <li>• 120 Ohms, 1/4 W internal resistance</li> </ul>	<b>Male</b> 
	<b>RKE 57-TR2</b>	Nickel Plated CuZn or Stainless Steel 250 V, 4 A -40° to +75°C IP 67	<b>eurofast</b> Terminating Resistor <ul style="list-style-type: none"> <li>• Female <b>eurofast</b> connector</li> <li>• 120 Ohms, 1/4 W internal resistance</li> </ul>	<b>Female</b> 

## DeviceNet™, Terminating Resistors

- Terminating Resistors Stabilize and Minimize Reflections on the Bus Line
- A Terminating Resistor is Required at the Beginning and End of the Main Bus Line

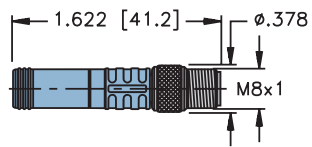
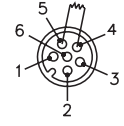
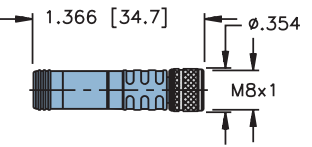
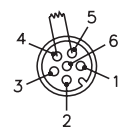

Housing	Part Number	Specs	Application	Pinouts
	PSGM 57-TR	Nickel Plated Brass or Stainless Steel 125 V, 2 A -40° to +105°C IP 67	<p><i>picofast</i>® Terminating Resistor</p> <ul style="list-style-type: none"> <li>• Male <i>picofast</i> connector</li> <li>• 120 Ohms, 1/2 W internal resistance</li> </ul>	<p><b>Male</b></p> <p>TERMINATING RESISTOR (120 Ω, 1/2W) BETWEEN PINS 4,5</p> 
	PKGM 57-TR			<p><b>Female</b></p> <p>TERMINATING RESISTOR (120 Ω, 1/2W) BETWEEN PINS 4,5</p> 

DeviceNet Media

# TURCK

## Network Media Products

### DeviceNet™, Receptacles

- Receptacles Provide Transition from Male to Female Connectors
- Available for Bulkhead and Feed Through Applications



Housing	Part Number	Specs	Application	Pinouts
	<b>RSF RKF 57/22</b>	Nickel Plated CuZn or Stainless Steel 300 V, 9 A -40° to +75°C IP 67	<b>minifast®</b> Bulkhead Receptacle • Straight male/female feed through	<p><b>Male</b></p> <p><b>Female</b></p>
	<b>FKM FS 57/M12</b>	Nickel Plated CuZn or Stainless Steel 250 V, 4 A -40° to +75°C IP 67	<b>euromast®</b> Bulkhead Receptacle • Straight male/female feed through	<p><b>Male</b></p> <p><b>Female</b></p>

Standard housing material is nickel plated brass. "RSF RKF.."; "RSFV RKFV.." indicates stainless steel housing.

**Panel Cutout**  
**RSF RKF 57/22**

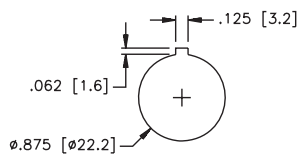

**Panel Cutout**  
**FKM FS 57/M12**

