

Smart Distributed System (SDS)

The Smart Distributed System, developed by Honeywell's MICRO SWITCH Division, is a bus system for intelligent sensors and actuators. The SDS system is based on **CAN** as defined in the Bosch V2.0 CAN Specification. SDS allows multiple nodes to share a single bus.

Over a single 4-wire cable, Smart Distributed System can interface up to 64 nodes with a maximum of 126 addresses. These intelligent sensor and actuator devices do more than just turn on and off. Smart Distributed System devices have advanced device-level functions, system and device diagnostics.

SDS is based on a three layer communication model. The **Application Layer** specifies system services and protocol. The **Data Link Layer** provides functions and procedures to establish, maintain and release data-link-connections among devices on the network and to transfer data-link-service-data-units. The **Physical Layer** provides the mechanical, electrical, functional and procedural means to activate, maintain and de-activate physical connections for bit transmission between data-link-entities. Physical Layer devices are interconnected by physical media.

TURCK

Network Media Products

SDS™, Micro Cable Specifications

- Cable that Meets the Physical Layer Specifications of Smart Distributed System (SDS)

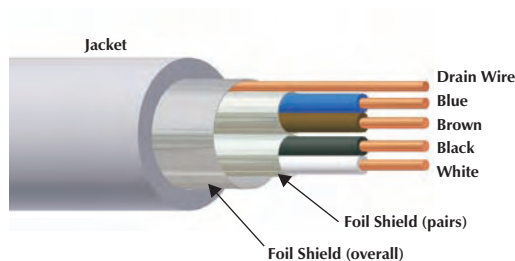





Maximum Trunk Lengths for various data rates independent of bus voltage drop

Maximum Trunk Length	Data Transmission Rate	Maximum Branch Length	Maximum Number of Nodes
22.8 meters (75 feet)	1 Mbit/s	0.3 meters (1 feet)	32
91.4 meters (300 feet)	500 Kbit/s	0.9 meters (3 feet)	64
182.8 meters (600 feet)	250 Kbit/s	1.8 meters (6 feet)	64
457.2 meters (1500 feet)	125 Kbit/s	3.6 meters (12 feet)	64

Type	Approvals	Power Pair		Data Pair		Outer Jacket	Shields	Bulk Cable Part Number / Weight/300 M
		AWG Color Code	DCR (/1000 feet) Insulation	AWG Color Code	DCR (/1000 feet) Insulation			
532 AWM 2464 75°C 300 Volts	NEC PLTC CEC AWM-I/II A/B FT4	2/22 AWG BU/BN	17 Ohms PVC	2/22 AWG WH/BK	17 Ohms PE	PVC Grey 7.3 mm (.285 in)	Foil 22 AWG	RB50604-*M 41 lbs.
531 AWM 2464 75°C 300 Volts	NEC PLTC CEC AWM-I/II A/B FT4	2/16 AWG BU/BN	4.3 Ohms PVC	2/22 AWG WH/BK	17 Ohms PE	PVC Grey 8.4 mm (.330 in)	Foil 22 AWG	RB50591-*M 69 lbs.
530 AWM 2464 80°C 300 Volts	NEC PLTC CEC AWM-I/II A/B FT4	2/16 AWG BU/BN	4.3 Ohms PVC	2/20 AWG WH/BK	10 Ohms PE	PVC Grey 10.4 mm (.409 in)	Foil 20 AWG	RB50628-*M 94 lbs.

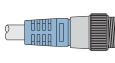
* Indicates length in meters.

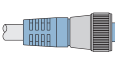
SDS™, Mini Cable and Cordset Selection Matrix - 530

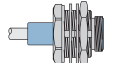
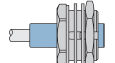
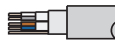
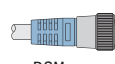
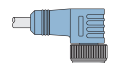
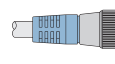
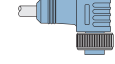
		<i>minifast</i> ®				<i>minifast</i>		
		Pin (Male)		Socket (Female)		Pin (Male)	Socket (Female)	
		1 	2 	3 	4 	9 	10 	
		RSM	WSM	RKM	WKM	RSFP	RKFP	
		RSM 530-*M	WSM 530-*M	RKM 530-*M	WKM 530-*M	RSFP 530-*M	RKFP 530-*M	
Bare								
<i>minifast</i>	Pin (Male)	1 	RSM RSM 530-*M	RSM WSM 530-*M	RSM RKM 530-*M	RSM WKM 530-*M	RSM RSFP 530-*M	RSM RKFP 530-*M
		2 		WSM WSM 530-*M	WSM RKM 530-*M	WSM WKM 530-*M	WSM RSFP 530-*M	WSM RKFP 530-*M
		3 			RKM RKM 530-*M	RKM WKM 530-*M	RKM RSFP 530-*M	RKM RKFP 530-*M
		4 				WKM WKM 530-*M	WKM RSFP 530-*M	WKM RKFP 530-*M
	Socket (Female)							

See pages S33 for dimensional drawings.

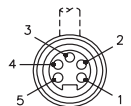
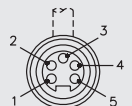

- * Indicates length in meters.
- Refer to the Cordset Builder at www.turck.com for assistance with cordset/cable combinations.
- Standard cable lengths are 1.0, 2.0, 4.0, 6.0, 10...15 meters. Consult factory for other lengths.
- For stainless steel coupling nuts change part number RSM ... to RSV, WSM ... to WSV.

<i>minifast</i>	Pinouts	<i>minifast</i>
<p>Male</p> 	<ol style="list-style-type: none"> 1. Bare (Shield Drain Wire) 2. Brown (+ Voltage) 3. Blue (- Voltage) 4. Black (CAN_H) 5. White (CAN_L) 	<p>Female</p> 

TURCK

Network Media Products

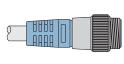
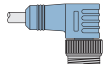
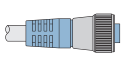
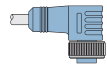
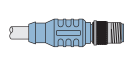
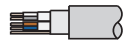
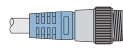
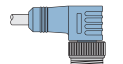
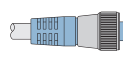
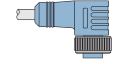
SDS™, Micro and Mid Cable and Cordset Selection Matrix - 532, 531

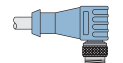
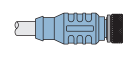
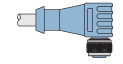
		<i>minifast</i> ®				<i>eurofast</i> ® (Thin/Mid Only)	
		Pin (Male)		Socket (Female)		Pin (Male)	
		1  RSM	2  WSM	3  RKM	4  WKM	5  RSC	
 Bare		RSM 53x-*M	WSM 53x-*M	RKM 53x-*M	WKM 53x-*M	RSC 53x-*M	
<i>minifast</i>	Pin (Male)	1  RSM	RSM RSM 53x-*M	RSM WSM 53x-*M	RSM RKM 53x-*M	RSM WKM 53x-*M	RSM RSC 53x-*M
	Pin (Male)	2  WSM		WSM WSM 53x-*M	WSM RKM 53x-*M	WSM WKM 53x-*M	WSM RSC 53x-*M
	Socket (Female)	3  RKM			RKM RKM 53x-*M	RKM WKM 53x-*M	RKM RSC 53x-*M
	Socket (Female)	4  WKM				WKM WKM 53x-*M	WKM RSC 53x-*M
<i>eurofast (thin/mid only)</i>	Pin (Male)	5  RSC					RSC RSC 53x-*M
	Pin (Male)	6  WSC					
	Socket (Female)	7  RKC					
	Socket (Female)	8  WKC					

See pages S33 - S34 for dimensional drawings.

* Indicates length in meters.

x Indicates cable type.

Standard cable lengths are 1.0, 2.0, 4.0, 6.0, 10....15 meters. Consult factory for other lengths.

For stainless steel coupling nuts change part number RSM ... to RSV, WSM ... to WSV.

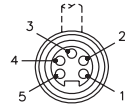
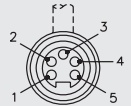
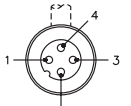
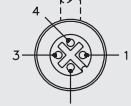
<i>minifast</i>	Pinouts	<i>minifast</i>	<i>eurofast</i>	Pinouts	<i>eurofast</i>
Male 	1. Bare (Shield Drain Wire) 2. Brown (+ Voltage) 3. Blue (- Voltage) 4. Black (CAN_H) 5. White (CAN_L)	Female 	Male 	1. Brown (+ Voltage) 2. Blue (- Voltage) 3. White (CAN_L) 4. Black (CAN_H)	Female 

SDS™, Micro and Mid Cable and Cordset Selection Matrix - 532, 531

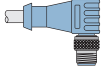
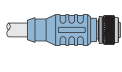
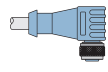
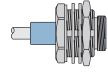
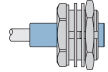
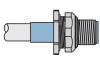
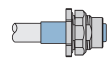
eurofast®			minifast® Bulkhead		eurofast Bulkhead	
Pin (Male)	Socket (Female)		Pin (Male)	Socket (Female)	Pin (Male)	Socket (Female)
6 	7 	8 	9 	10 	11 	12 
WSC	RKC	WKC	RSFP	RKFP	FSFD	FKFD
WSC 53x-*M	RKC 53x-*M	WKC 53x-*M	RSFP 53x-*M	RKFP 53x-*M	FSFD 53x-*M	FKFD 53x-*M
RSM WSC 53x-*M	RSM RKC 53x-*M	RSM WKC 53x-*M	RSM RSFP 53x-*M	RSM RKFP 53x-*M	RSM FSFD 53x-*M	RSM FKFD 53x-*M
WSM WSC 53x-*M	WSM RKC 53x-*M	WSM WKC 53x-*M	WSM RSFP 53x-*M	WSM RKFP 53x-*M	WSM FSFD 53x-*M	WSM FKFD 53x-*M
RKM WSC 53x-*M	RKM RKC 53x-*M	RKM WKC 53x-*M	RKM RSFP 53x-*M	RKM RKFP 53x-*M	RKM FSFD 53x-*M	RKM FKFD 53x-*M
WKM WSC 53x-*M	WKM RKC 53x-*M	WKM WKC 53x-*M	WKM RSFP 53x-*M	WKM RKFP 53x-*M	WKM FSFD 53x-*M	WKM FKFD 53x-*M
RSC WSC 53x-*M	RSC RKC 53x-*M	RSC WKC 53x-*M	RSC RSFP 53x-*M	RSC RKFP 53x-*M	RSC FSFD 53x-*M	RSC FKFD 53x-*M
WSC WSC 53x-*M	WSC RKC 53x-*M	WSC WKC 53x-*M	WSC RSFP 53x-*M	WSC RKFP 53x-*M	WSC FSFD 53x-*M	WSC FKFD 53x-*M
	RKC RKC 53x-*M	RKC WKC 53x-*M	RKC RSFP 53x-*M	RKC RKFP 53x-*M	RKC FSFD 53x-*M	RKC FKFD 53x-*M
		WKC WKC 53x-*M	WKC RSFP 53x-*M	WKC RKFP 53x-*M	WKC FSFD 53x-*M	WKC FKFD 53x-*M

SDS™, minifast® Cordset and Receptacle Connector Dimensions

Specifications

Housing:	PUR (Polyurethane)
Coupling Nut:	Nickel Plated CuZn or Stainless Steel
Contact Carrier:	TPU (Polyurethane)
Contacts:	Gold Plated CuZn
Protection:	NEMA 1, 3, 4, 6P and IEC IP 68
Rated Voltage:	300 V
Rated Current:	9 A
Ambient Temperature:	-40° to +75°C (-40° to +167°F)

1

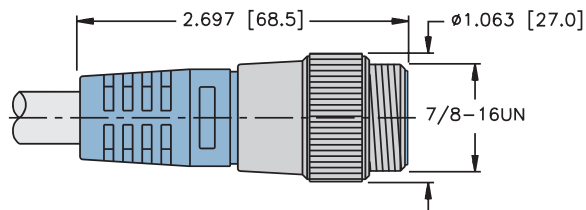

RSM ..

Pages S30 - S32

3

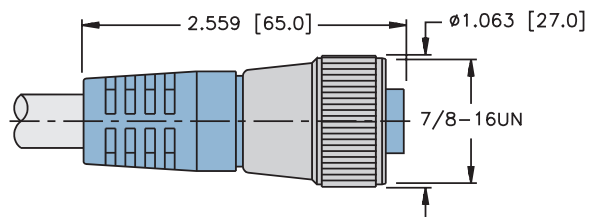

RKM ..

Pages S30 - S32

2

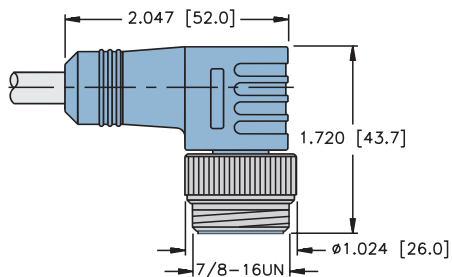

WSM ..

Pages S30 - S32

4

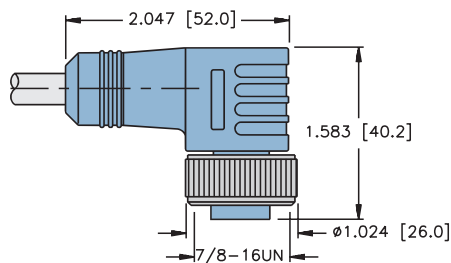

WKM ..

Pages S30 - S32

9

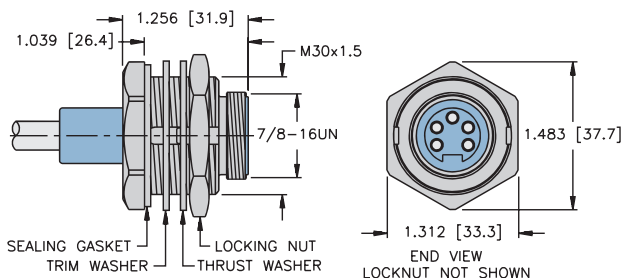

RSFP ..

Pages S30 - S32

10

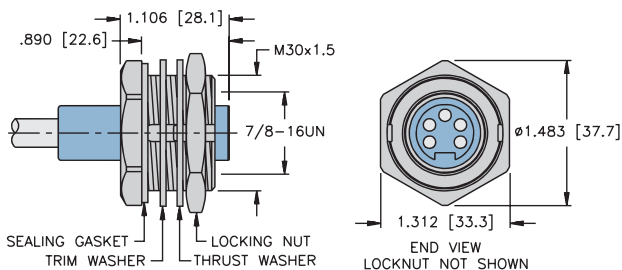

RKFP ..

Pages S30 - S32

SDS™, eurofast® Cordset and Receptacle Connector Dimensions

Specifications

Housing:	PUR (Polyurethane)
Coupling Nut:	Nickel Plated CuZn or Stainless Steel
Contact Carrier:	TPU (Polyurethane) or POM (Nylon)
Contacts:	Gold Plated CuZn
Protection:	NEMA 1, 3, 4, 6P and IEC IP 68
Rated Voltage:	250 V
Rated Current:	4 A
Ambient Temperature:	-40° to +75°C (-40° to +167°F)

5

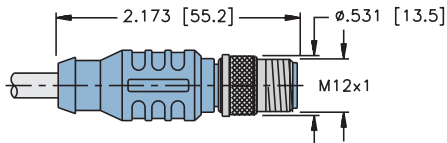

RSC ..

Pages S30 - S32

7

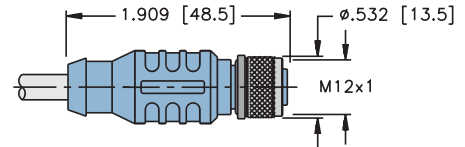

RKC ..

Pages S30 - S32

6

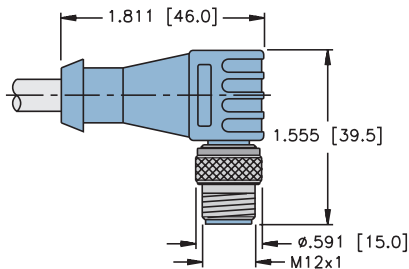

WSC ..

Pages S30 - S32

8

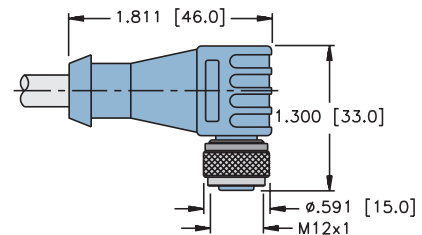

WKC ..

Pages S30 - S32

11

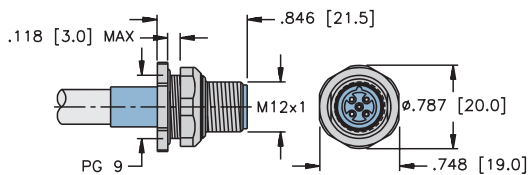

FSFD ..

Pages S30 - S32

12

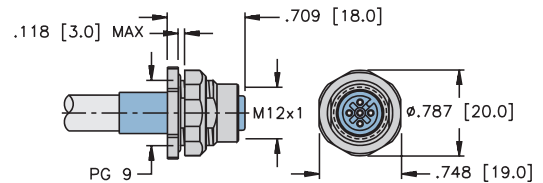

FKFD ..

Pages S30 - S32

TURCK

Network Media Products

SDS™, eurofast® Passive Multiport Junctions

- Rugged, Fully Encapsulated Enclosure
- For Connecting I/O in Concentrated Areas
- Bus-In / Bus-Out Eliminates Need for Splitter Tee



Part Number	Specs	Application	Wiring Diagrams
JBBS-53-E401	Die-cast aluminum enclosure.	<p>4-port Junction</p> <ul style="list-style-type: none"> • Bus in/bus out straight (7/8-16UN) <i>minifast</i>® through ports • Four device ports with (M12x1) <i>eurofast</i> connectors 	
JBBS-53-E601		<p>6-port Junction</p> <ul style="list-style-type: none"> • Bus in/bus out straight (7/8-16UN) <i>minifast</i> through ports • Six device ports with (M12x1) <i>eurofast</i> connectors 	
JBBS-53-E801		<p>8-port Junction</p> <ul style="list-style-type: none"> • Bus in/bus out straight (7/8-16UN) <i>minifast</i> through ports • Eight device ports with (M12x1) <i>eurofast</i> connectors 	

Specifications

Housing:	Anodized Aluminum
Coupling Nut:	Nickel Plated CuZn or Stainless Steel
Contact Carrier:	TPU (polyurethane or POM (Nylon))
Contacts:	Gold Plated CuZn
Protection:	NEMA 1, 3, 4, 6P and IEC IP 68
Rated Voltage:	250 V
Rated Current:	4 A
Ambient Temperature:	-40°C to +75°C

Dimensions

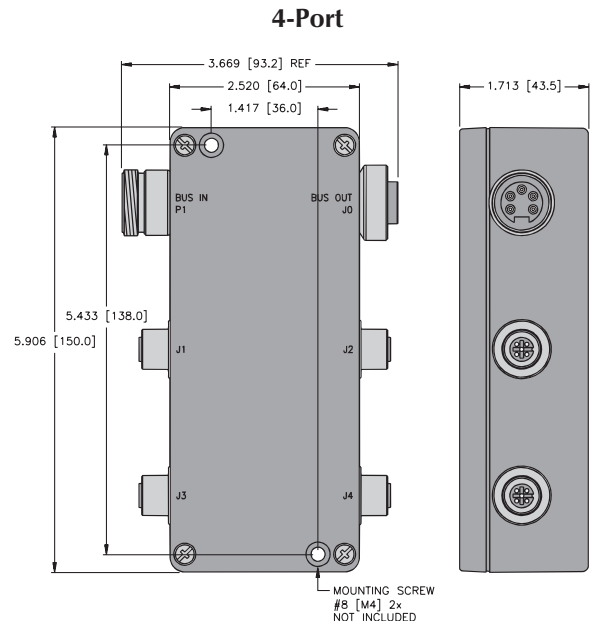
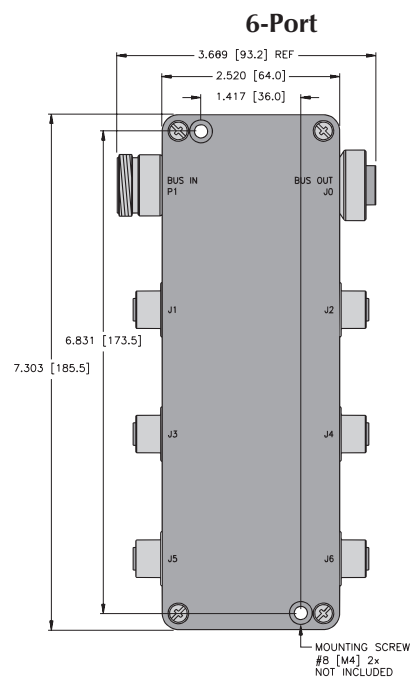
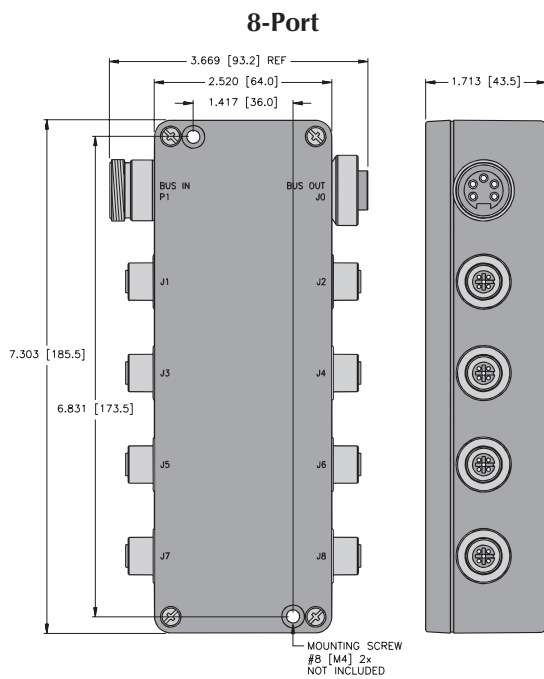

Pinouts

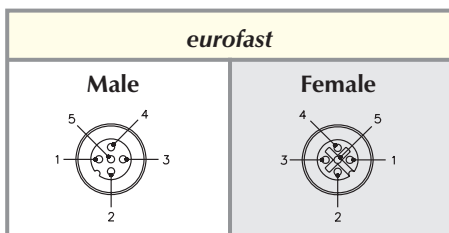

TURCK

Network Media Products

SDS™, Terminating Resistors

- Stabilize and Minimize Reflections on the Bus Line
- Required at the Beginning and End of Bus Line



Housing	Part Number	Specs	Application	Pinout
	RSM 53-TR2	Nickel Plated Brass or Stainless Steel 300 V, 9 A -40°C to +75°C	minifast ® Terminating Resistor <ul style="list-style-type: none"> • Internal resistor • Male minifast connector 	Male
	RSE 53-TR2	Nickel Plated Brass or Stainless Steel 250 V, 4 A -40°C to +75°C	eurofast ® Terminating Resistor <ul style="list-style-type: none"> • Internal resistor • Male eurofast connector 	Female