

IM72-11Ex/L

Solenoid Driver/Discrete Output Isolators

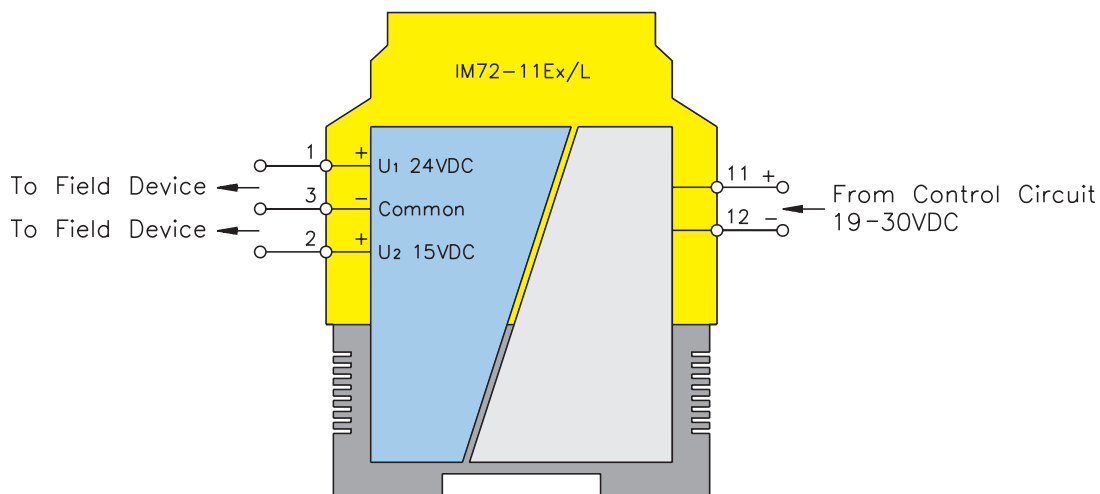

Functional Description:

This single channel device is designed to drive the vast majority of intrinsically safe solenoids available, as well as "IS" displays and other field devices that may require a separate "IS" power source. The unique design allows different configurations to be implemented depending on the specific field device being used.

Loop power is applied from a non-hazardous area source directly to the non-hazardous area inputs eliminating the requirement for additional power supply connections.

Features:

- 1 channel solenoid driver or "IS" supply
- Loop powered
- 2 output levels
- Switching frequency up to 500 Hz

Electrical Parameters:

Inputs: Hazardous Area

- Supply (Loop Power)
- Signal "OFF" <5 V
- Signal "ON" 19-30 VDC
- Switch-on delay <400 μ

Outputs: Non-Hazardous Area

- In accordance with Output Curve:
- U1=24 V (Pins 1 & 3)
- U2=15 V (Pins 2 & 3)
- I1= 45 mA (Pins 1 & 3)
- I2=45 mA (Pins 2 & 3)
- Switching Frequency <500 Hz

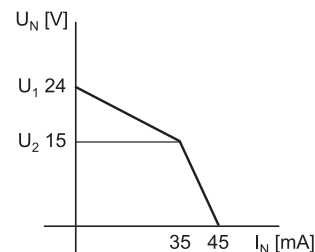

For entity parameters see control drawings on pages B86 - B91.

Solenoid Driver/Discrete Output Isolators **IM72-11Ex/L**

Pin #	Terminal Function
1	U1 Field Output
2	U2 Field Output
3	Common Field Output
4	No Connection
5	No Connection
6	No Connection
7	No Connection
8	No Connection
9	No Connection
10	No Connection
11	(+) Non-Hazardous Area Input
12	(-) Non-Hazardous Area Input

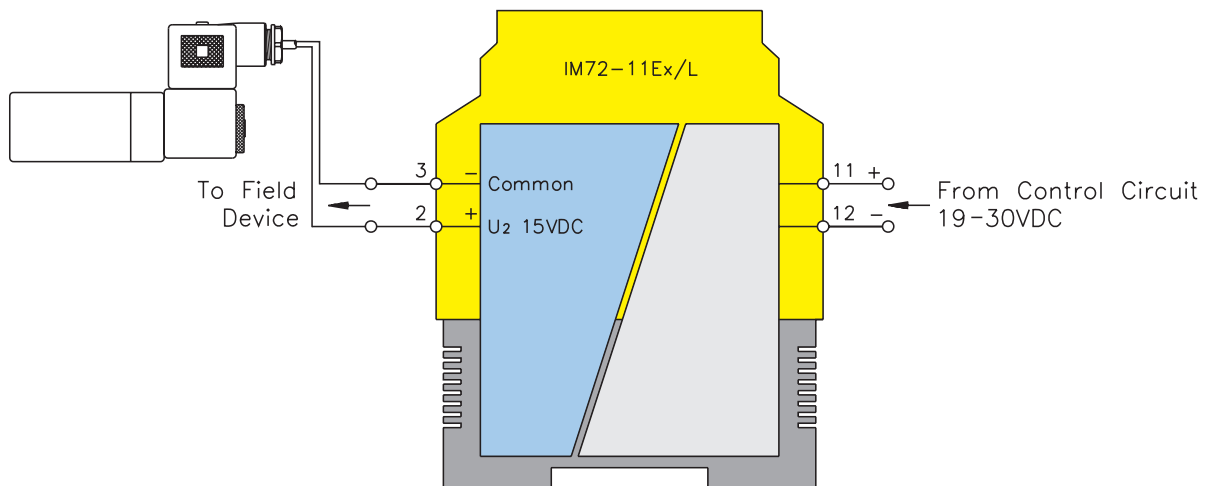
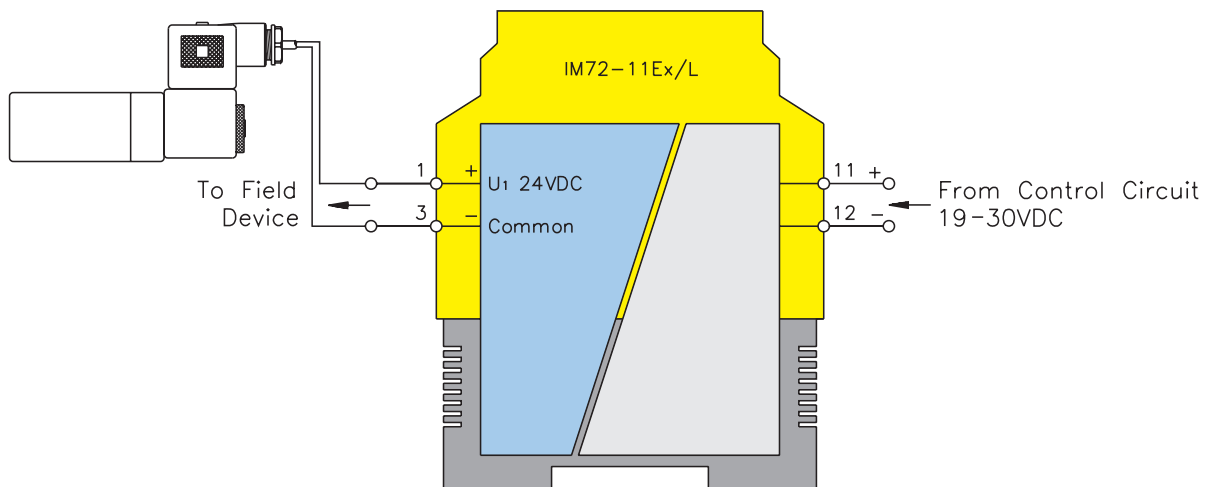

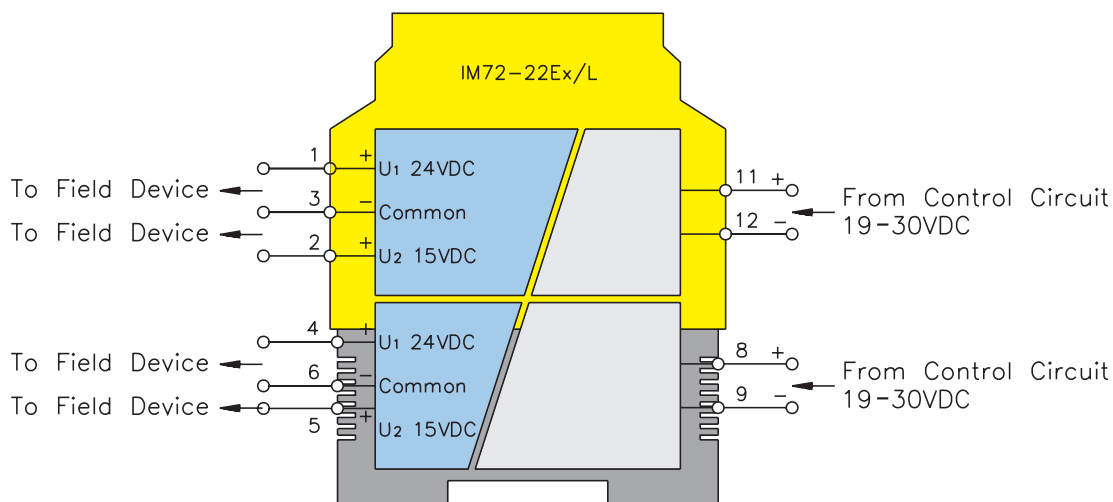

Functional Description:

This dual channel device is designed to drive 2 separate intrinsically safe solenoids, "IS" displays or other field devices that may require a separate "IS" power source, or any combination of these devices. The unique design allows different configurations to be implemented depending on the specific field device or devices being applied.

Loop power is applied from a non-hazardous area source directly to the non-hazardous area inputs of each channel eliminating the requirement for additional power supply connections.

Features:

- 2 channel solenoid driver or "IS" supply
- 2 isolated loop powered circuits
- 2 output levels per channel
- Switching frequency up to 500 Hz

Electrical Parameters:

Inputs: Hazardous Area

Supply (Loop Power)

- Signal "OFF" <5 V
- Signal "ON" 19-30 VDC
- Switch-on delay <400 μ

Outputs: Non-Hazardous Area

In accordance with Output Curve:

- U1=24 V (Pins 1 & 3, 4 & 6)
- U2=15 V (Pins 2 & 3, 5 & 6)
- I1= 45 mA (Pins 1 & 3, 4 & 6)
- I2=45 mA (Pins 2 & 3, 5 & 6)
- Switching Frequency <500 Hz

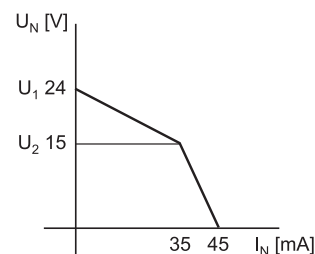

For entity parameters see control drawings on pages B86 - B91.

Solenoid Driver/Discrete Output Isolators IM72-22Ex/L

Pin #	Terminal Function
1	U1 Field Output
2	U2 Field Output
3	Common Field Output
4	U1 Field Output
5	U2 Field Output
6	Common Field Output
7	No Connection
8	(+) Non-Hazardous Area Input
9	(-) Non-Hazardous Area Input
10	No Connection
11	(+) Non-Hazardous Area Input
12	(-) Non-Hazardous Area Input

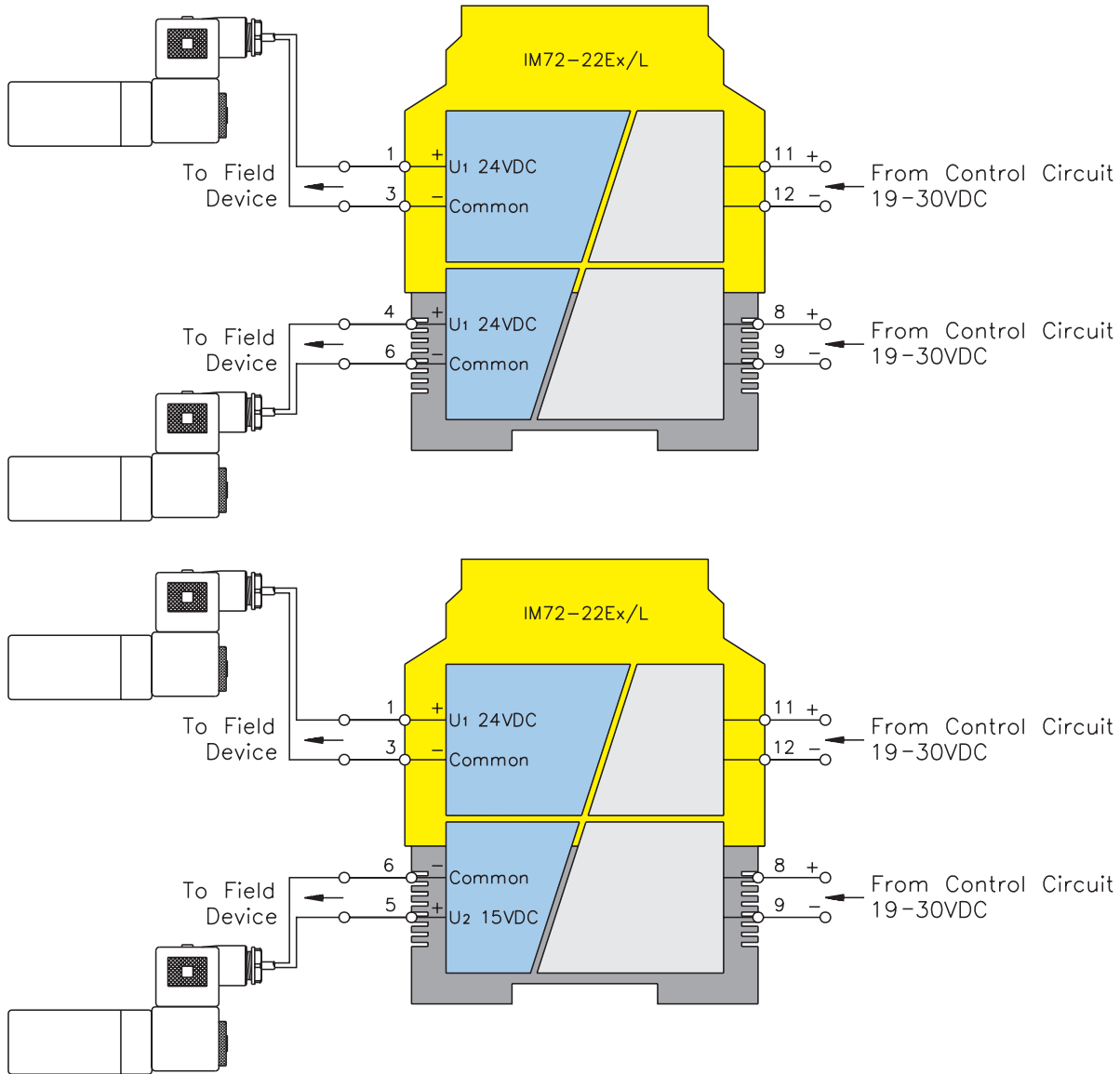

TURCK

Process Automation – IS Interface Technology

IM72-22Ex/L

Solenoid Driver/Discrete Output Isolators

Pin #	Terminal Function
1	U1 Field Output
2	U2 Field Output
3	Common Field Output
4	U1 Field Output
5	U2 Field Output
6	Common Field Output
7	No Connection
8	(+) Non-Hazardous Area Input
9	(-) Non-Hazardous Area Input
10	No Connection
11	(+) Non-Hazardous Area Input
12	(-) Non-Hazardous Area Input

