

Signal monitoring in safety-critical circuits

Coupling relays with positively driven contacts

Weidmüller has expanded the RIDERSERIES to include a relay variant with force-guided contacts. Relays with force-guided contacts have a 99 % diagnostics coverage and an excellent reputation for use in safety systems. The contacts interlock mechanically with each other in order to ensure a synchronous switching status of both contacts. This guarantees that the alert contact will maintain the same switching status in the event of an error (for example, if the working contact melts from an overload). The controller (or safety controller) detects the alert contact and then compares the set point and actual values. If a difference occurs, measures can then be taken to protect equipment and human life.

Resistant to vibration

A metal clip ensures that the relay module remains secure even under vibration / mechanical shock conditions.

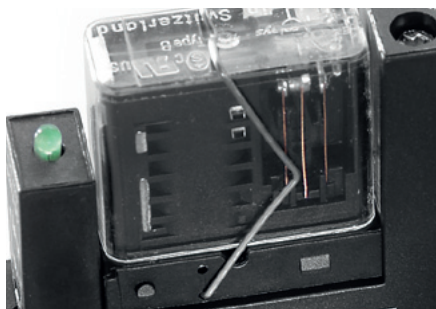
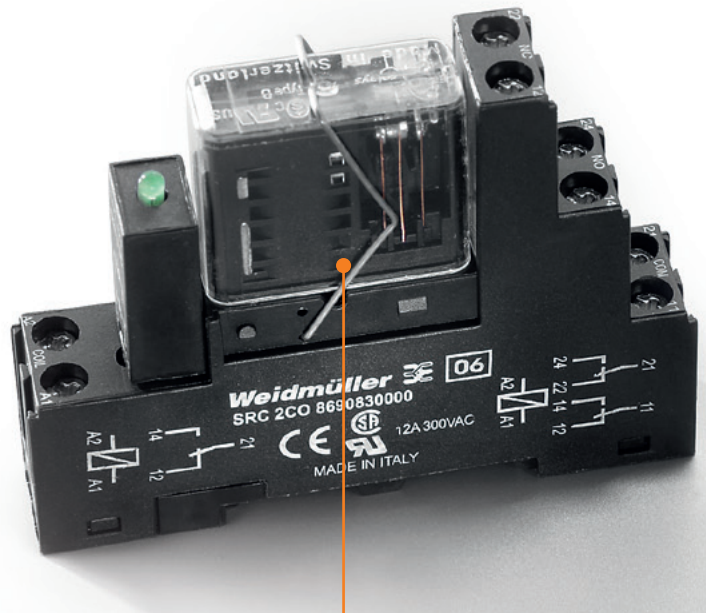

A variety of connection options

The base is available either with the proven screw clamp connection or the time saving tension clamp connection.

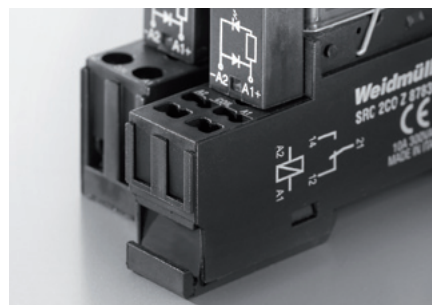

Convenient

Relay modules can be replaced quickly in the event of a fault without removing the connecting cable.

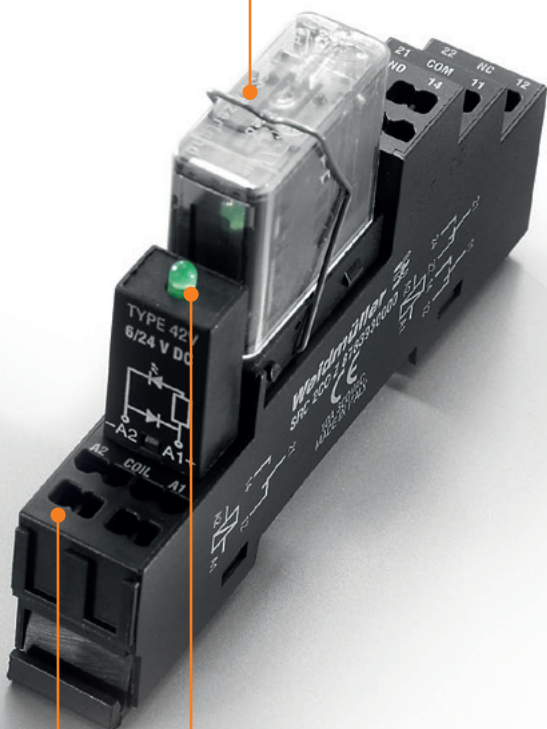
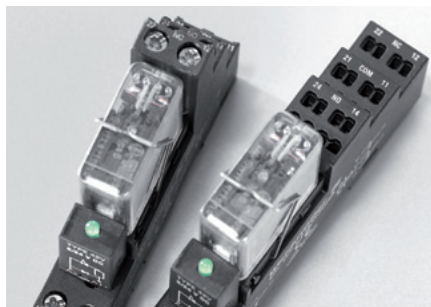

On site diagnostics

An easy to view LED display module with an integrated free wheeling diode is used to protect the series connected electronics.

Safety-based output relay controls

By connecting two coupling relays together with a safety based controller or safety switching devices, it is possible to set up a safe and efficient control mechanism that complies with the structure specified in EN ISO 13849-1 (Category 3 and 4).

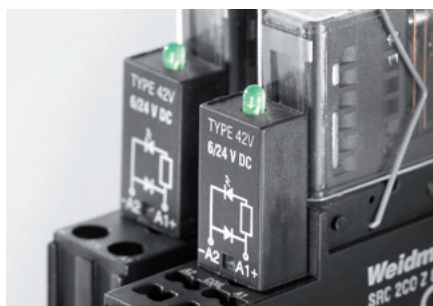
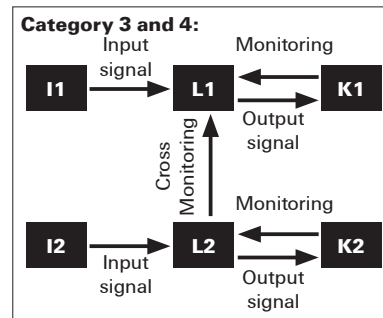

RIDERSERIES FG – relay modules

RCI KIT with forcibly guided contacts

2 CO DC coil

Modular system comprising of:

- Relay socket for rail mounting
- LED indicator unit
- Retaining clip
- Pluggable relay modules
- Markers



B

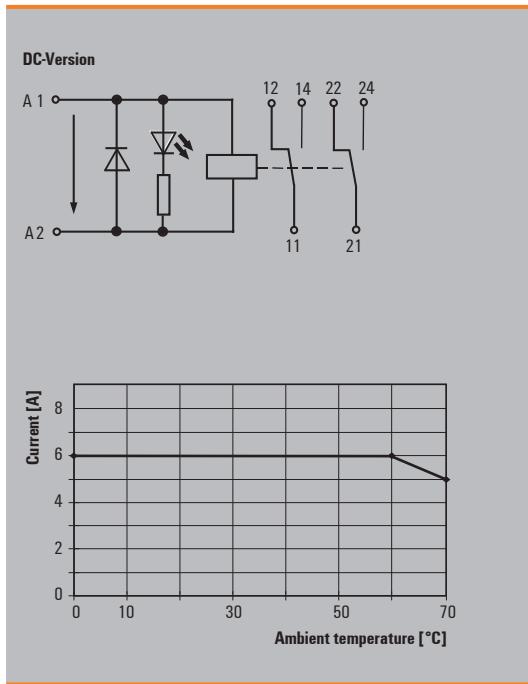

Technical data

Output		
Rated switching voltage / Continuous current	250 V AC / 6 A	
Max. switching voltage, AC	250 V	
Making current	15 A / 20 ms	
Min. switching power	100 mA / 5 V, 10 V / 10 mA, 24 V / 1 mA	
Max. switching power	1500 VA	
Contact material	AgCuNi	
Mechanical service life	> 50 x 10 ⁶ switching cycles	
Max. switching frequency at rated load	20 Hz	
Rated data		
Ambient temperature (operational)	-40 °C...+70 °C	
Storage temperature	-40 °C...+85 °C	
Humidity	40 °C / 95 % rel. humidity, no condensation	
Approvals	CE	
Insulation coordination (EN 50178)		
Rated voltage	250 V	
Impulse withstand voltage		
Dielectric strength input - output	5 kV _{eff} / 1 min	
Dielectric strength, contact / contact	4 kV _{eff} / 1 min	
Dielectric strength to mounting rail		
Creepage and clearance distance input - output	≥ 10 mm	
Surge voltage category	III	
Pollution severity	3	
Dimensions		
	Screw connection	Tension clamp connection
Clamping range (nominal / min. / max.)	mm ² 2.5 / 0.5 / 2.5	1.5 / 0.5 / 1.5
Depth x width x height	mm 62 / 15.5 / 77	63.2 / 16 / 97
Note		

Ordering data

Input		24 V DC 2CO LED	
Rated control voltage		24 V DC	
Rated current AC / DC		/ 35.8 mA	
Power rating		0.82 W	
AC response/dropout Volt			
DC response/dropout Volt		18 V / 2.4 V	
Status indicator		Green LED	
Protective circuit		Integrated free-wheel diode	
Output			
Switch-on delay		≤ 12 ms	
Switch-off delay		≤ 6 ms	

Ordering data			
Screw connection	Type	RCIKIT 24VDC 2CO LD/FG	
	Order No.	1218410000	
Tension clamp connection	Type	RCIKITZ 24VDC 2CO LD/FG	
	Order No.	1218390000	

Ordering data			
Spare relay			
	Type	RCI42424FG	
	Order No.	1218380000	

Note			