

Relay coupler – overview

Weidmüller **relay modules** have a universal foot structure so that they can be fitted in rows on the TS 32, TS 35 x 7.5 and TX 35 x 15 mounting rails acc. to EN 50 035 and EN 50 022.

In the coil circuit of the relay modules, an LED status indication shows the switching state of the relay.

Our highlight:
MICROSERIES

Coupler modules in terminal format

The slot-in width of 6.1 mm allows for space-saving installation of the **MICROSERIES** relays in a wide range of applications. The **MICROSERIES** is particularly suitable for the modification and extension of installations and machinery. In such cases, it helps to make optimum use of the limited space available in switchgear cabinets.

Marking

The tab surfaces enable equipment to be clearly marked using a WS marker.



Holding and ejecting mechanism

The innovative holding and eject mechanism clips the assembled module securely onto the basic terminal. With the reliable eject function, the coupler can be removed quickly and simply from the base.

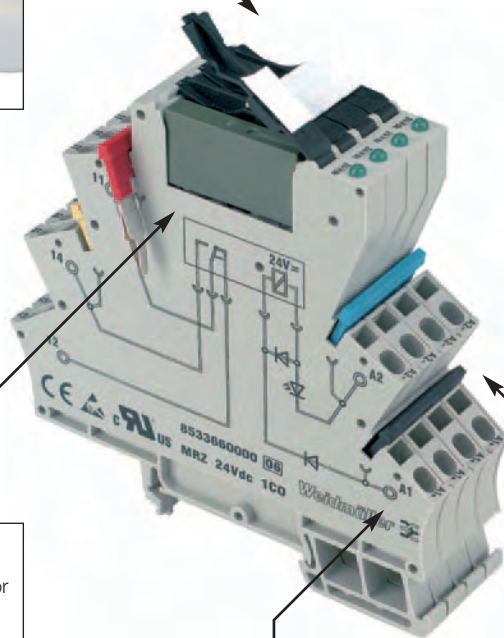

Relay and optocoupler module

Plug-in relay and optocoupler modules allow for individual adjustment of the module functions. Relay couplers are available with different power outputs with either AgSnO and gold contacts.

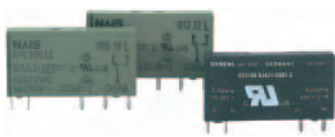

Connection technology

Most of our relay couplers are available with screw or tension clamp connections.

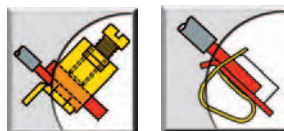

Pluggable cross-connectors

The ZQV 4N plug-in cross-connectors are available in various colours and with different numbers of poles. They allow for reliable and distinct cross-connections between the four input and output potentials.

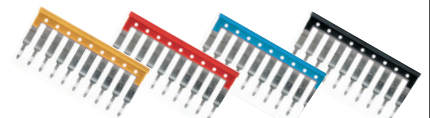

Relay coupler – overview

Contact types

Several contact types and combinations are available ex stock:

- 1 NCC (EGR EG7, RS 30)
- 1 NOC (EGR RG7, DKR, RS 30)
- 1 NCC and 1 NOC (WRS)
- 2 NOCs (WRS)
- 3 NOCs (WRS)
- 1 change-over contact (EGR/RST EG7, WRS, DKR, PRS/PRZ MCZ R, RS 30, RS 31)
- 2 change-over contacts (WRS, RS 32, PRS/PRZ)
- 4/8/16 change-over contacts (RSM)

Protective circuits for the contacts

The switching of inductive or capacitive loads produces switching sparks which can influence the electrical service life of the relays.

The following protective circuits for the contacts reduce contact wear:

Diode

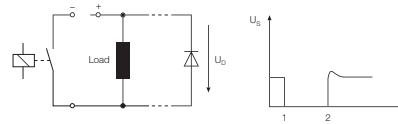

- Advantage: Can be used for all capacities, low overvoltage, minimum space required, low price
- Disadvantage: Very large release delay

Diode and Z-diode

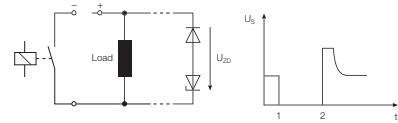

- Advantage: Low overvoltage (defined by Z-diode), low release delay
- Disadvantage: Cannot be used for large capacities

Contact material

The relay modules are suitable for universal use, with the choice of contact material the crucial criterion. The contact is used for safe transmission of control signals and also for switching power contactors.

Gold-plated or gold-flashed AgNi contacts are used for most applications. Hard gold plated contacts with gold plating exceeding 2 μm in thickness allow even extremely small capacities (up to 40 μW) to be switched. AgSnO₂ or AgCdO contacts are used for switching higher capacities (RS 31).

RC combination

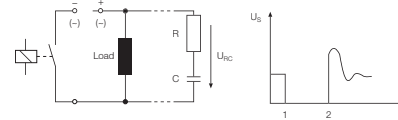

- Advantage: Low overvoltage, low release delay
- Disadvantage: High current load on the contacts when switching on; more complicated and expensive at greater capacities

Varistor

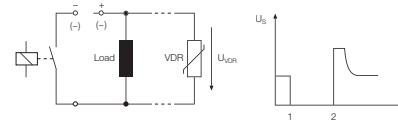

- Advantage: Low release delay, low price
- Disadvantage: Cannot be used for all operating voltages and capacities

- U_S Voltage progression
- 1 Closing
- 2 Opening

Switching small and large capacities

For automation technology, the EGR EG7 relay coupler is ideal for switching extremely small capacities (up to 40 μW) under ohmic load. The signals are reliably transmitted to the controllers. The switching of large capacities for energy and supply technology is achieved by the RS31 relay coupler, with a guaranteed switching capacity of 3.5 kVA under ohmic load.

Switching times of the relay modules

Typical pick-up delay < 10 ms
Typical release delay < 12 ms

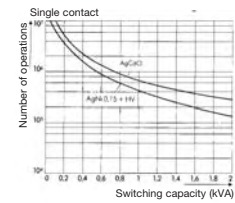

Contact service life under ohmic load

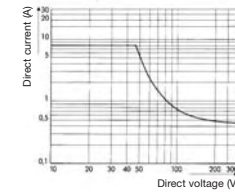

DC load-limit curve under ohmic load

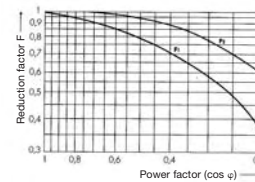

Reduction factor under inductive load
cos φ < 1

No. of cycles_{eff.} = No. of cycles at (cos φ = 1) × red. factor F

Relay coupler – overview

Relay coupler with plugged relay

Relay couplers with plugged relay have only limited suitability for use in a highly oscillating environment. Preference should be given to relay couplers with soldered relays.

Derating curve

The transition resistance of the relay contacts is a key factor contributing to temperature increase inside the relay modules. This relationship is illustrated by a derating curve, defined as the function of the permissible current plotted against the ambient temperature.

The permissible current (Curve a) is determined for the following operating conditions:

- Continuous operation
- Rated input voltage + 10 percent
- Several relay modules working under load, mounted horizontally in rows on mounting rail, without any spacing

If the modules are mounted with a spacing > 20 mm, this results in a higher current load (Curve b). Curve b also shows the maximum values for switching or short-time operation in horizontally mounted state.

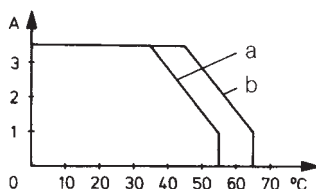

Notes on application

The key data of the triggering device must be precisely adhered to when using UC versions in DC circuits. As a result of their pre-circuitry, UC versions take up larger quantities of current. The internal current limit of standard initiators can mean that the triggered relay couplers are not switched through.

Relay couplers with 24 V AC/DC input are not suitable for triggering by initiators; purely DC versions are recommended for these applications.

RC combination

Long leads are subject to greater electrical and electromechanical influences. This may cause malfunctions and even failure of the relay modules. One possible remedy is to insert an RC combination to filter out the interference. RC combinations are available for all common relay couplers, as pluggable (PLUGSERIES) solutions or WDU 12C and DKU 12C terminals.

Relay coupler – overview

Definition of the technical data

Protective separation

All equipment guaranteeing “protective separation” is to be designed so that any faults (e.g. mechanical faults) cannot affect the insulation. If a mechanical fault occurs in a relay (bent soldering post, broken winding wire or broken spring), “protective separation” must also be guaranteed in such cases.

Relays are specified and tested to IEC 255 and VDE 0435. Neither standard makes reference to EN 50 178 (electronic equipment for use in high current installations), nor do they contain a definition of “protective separation”. Furthermore, other measuring conditions are used as the basis for the test voltages stated for the relays. So the test voltages cannot be transferred to EN 50 178 or DIN VDE 0106 part 101. In view of the fact that users are increasingly turning to equipment which guarantees “protective separation”, many relay manufacturers now refer to DIN VDE 0106 and test their products accordingly. The stated values then correspond with “protective separation”.

Standards

The following standards are fulfilled:

- EN 50 178:
Electronic equipment for use in high current installations
- DIN VDE 01206 part 101:
Protection from dangerous body currents, basic requirements for “protective separation” in electrical equipment
- IEC 255, DIN VDE 0109:
Insulation coordination for equipment within low-voltage systems, including clearance and creepage distances for configured printed circuit boards
- DIN VDE 0435:
Electrical relays, switching relays

Input circuit

Rated voltage [V]	Reference voltage at which the relay coupler works Typical input voltage => 5 Vdc, 12, 24, 48, 60, 115, 230 ac/dc
Rated current [mA]	Quotient of input voltage and input resistance Input resistance => coil resistance + resistance of the triggering device (R; LED; GL; ...)
Nominal consumption [W/VA]	Input voltage x input current dc/ac with tolerance +/-10% or +5/-15% typical range for relay coupler 250 mW > Pv > 1 W 0.4 VA > Pv > 1.2 VA
Operating voltage [V]	Smallest input current needed for the relay coupler to respond (Tu = 293 K)
Pull-in current [mA]	Smallest input current at which the relay switches from idle to working position (Tu = 293 K)
Response power [W/VA]	Product of operating voltage and pull-in current
Drop-out voltage [V]	Voltage at which the relay reliably drops away
Release current [mA]	Input current at which the relay reliably drops away

Output circuit

Max. switching voltage [V]	Max. voltage allowed at the relay contact
Switch-on current [A]	Current allowed to flow for max. 4 seconds after the relay contact closes
Continuous current [A]	Current allowed to flow constantly after the contact closes
Switching power [W/VA]	Product of output voltage and switch-on current, under ohmic, inductive or capacitive load
Min. switching power [µW]	Smallest power to be switched via the contact
Service life	No. of switching cycles until the contact fails – mechanical => without electric load – electrical => under ohmic or inductive ac/dc load
Response time [ms]	Time from closing the exciter voltage until the contact closes/opens
Release time [ms]	Time from opening the exciter voltage until the contact closes/opens
Switching frequency [Hz]	Switching circuits/sec. in pulse duty factor 1:2 (ton = toff)
Voltage strength [kV]	Max. test voltage between input and output circuit which does not cause a discharge
Protective separation	Relay coupler acc. to EN 50178 or VDE 0106 part 101
Light arc	Flow of current on opening contacts, caused by ionisation
Contact wear	The switching of inductivity causes extensive material migration Results: => Scratches and tip formation on contact surfaces => Failure caused by contacts interlocking
Spark extinction	Limitation of transient overvoltage by switching the inductive load: => RC combinations => Z-diodes / suppressor diodes => varistors
Reduction factor	Factor by which the service life is reduced when switching inductive loads

Relay coupler – overview

Enclosure types for relay couplers

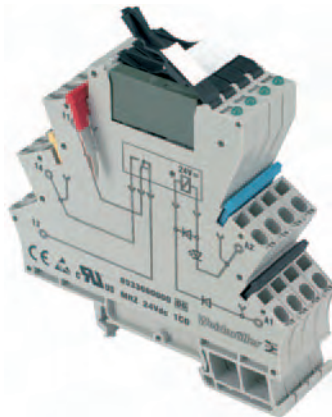
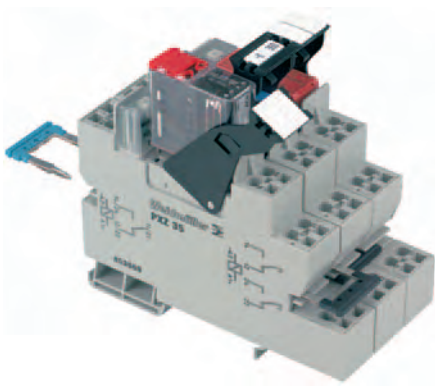

PLUGSERIES

The modular component system represents a new generation of pluggable relay couplers. The key element is an innovative relay base designated PXS (screw clamp) or PXZ (tension clamp). Both products reflect the functionality of relays and terminals, and experience gained from their commercial use. PLUGRELAY is the ideal connection system between the relay and the application.

Modular principle

The new PLUGSERIES is extremely easy to handle. Commercially available relays are simply plugged in, retaining clips provide a firm hold, and LED displays with a freewheel diode can be plugged in.

- Relays simply plugged in: suitable for miniature circuit of both standard and RT designs
- Independent connection technology: screw connection or tension spring technology, nominal cross-sectional area 0.5 ... 2.5 mm²
- Robust design of the retaining clip
- One or two change-over contacts; max. switching current 16 A
- Minimum wiring workload thanks to ZQV 2.5N pluggable cross-connectors
- Modular system makes for easy handling:
 - Relay base, LED display, retaining hook and relay
 - Clips on to TS 35
 - Marking with WS tabs on retaining hook
- Pluggable LED with freewheel diode.

MICROSERIES

Relay and optocoupler versions in the MICROSERIES are used in industrial automation applications for separating and coupling digital input and output signals. The compact design makes them perfectly suited for use in sub-distributors or switch cabinets. With its compact shape, MICROSERIES combines the functions of the classical coupling level with the terminal level.

- Slot-in width 6.1 mm
- Pluggable cross-connection for four input and output potentials
- Tried and tested ZQV 4N cross-connection system
- Wide range of input voltage from 5 .. 230 V
- LED status display, reverse polarity protection diode, recovery diode
- Enclosure material WEMID (combustibility V0 acc. to UL 94)
- Innovative holding and ejecting mechanism
- Marking surface to take standard marking WS 12/6

CE marking

Weidmüller's relay couplers carry the CE mark and comply with the requirements laid down by EN 50 081 part 1 and EN 50 082 part 2. They can be used in both in a wide range of applications and industries

Suitable ESD measures must be taken during installation. Overvoltage protection must be provided for long leads as protection from lightning.

WAVESERIES

Innovative electronic components require an enclosure or housing which reflects their specific functions. It must allow for adjusting and control functions and support technical requirements, such as heat dissipation or electromagnetic compatibility. A compact design saves space in the switch cabinet and reduces assembly costs. Ergonomic design is increasingly important for top quality relay coupler interfaces.

The WAVEBOX fulfils all these criteria, with outstanding features including:

- Assembly without tools
- Pluggable circuit board
- ZQV 2.5V pluggable cross-connector
- Hinged transparent cover
- Marking with WS tabs
- Clips onto TS 35

Connection systems

The user can choose between BLZ screw plug-in connectors and BLZF tension clamp plug-in systems, up to 2.5 mm² and finely stranded, for the greatest possible flexibility when wiring up the circuits.

Printed circuit board

If the lateral locking hook is squeezed on the head end, it can be pulled out of the enclosure together with the connection level and the circuit board.

The circuit board can only be pulled out without current voltage.

Cross-connector

The ZQV 2.5 N/2 cross-connectors can be used to connect rows of Wavebox housings in the lower part of the enclosure. The cross-connector can take up to 8 A of current. It can be used for bridging the supply voltage from one electronic module to another. The voltage at the cross-connector must not exceed 50 V.

Ventilation slits

Diagonal ventilation slits ventilate the lower parts of the enclosures and keep temperatures moderate.

Relay coupler – overview

Enclosure types for relay couplers



RS SERIES

Clip-in bases with relay RS 30, 31, 32 have a width of 11.2 mm to 25 mm, depending on the type. The open snap-in profile means that relay couplers can be designed for plugging in. The modules on the snap-in base have screw clamp units or flat plug-in connections for connection to the conductor. The following conductors can be connected:

- Solid: 0.5...4 mm²,
- Flexible: 0.5...2.5 mm².

Snap-in base with multiple interface

RSM multiple interfaces are assembled with a choice of 4, 8 or 16 relays. Versions with a joint plus or minus potential are available to save wiring on the input side. LP connection elements are equipped screw connections and are suitable for connecting the following conductor cross-sectional areas:

- Solid: 0.5...4 mm²,
- Flexible: 0.5...2.5 mm².

Variations on the RSM coupler have pre-fabricated male connectors acc. to IEC 603-1/DIN 41 651.

DK SERIES

All components in the DKR mini-coupler are extremely narrow: use of advanced surface-mounted parts (SMD) allows the width to be kept to just 6 mm. The range includes 4 or 5 screw connections for conductor cross-sectional areas of 0.5 ... 4 mm². The mini couplers offer a wide range of applications for coupling digital sensor/actuator signals with automation devices and the process field. DKR relay couplers can be used to pick up and standardise signals from the field with different voltages.

MCZ SERIES

The MCZ enclosure is only 6 mm wide and one of the narrowest of its kind. Its outstanding technical features include:

- Tension clamp connection to reduce assembly costs
- Integrated input/output cross-connection to reduce wiring workload

MCZR mini-conditioners (relay couplers) have 4 or 5 tension clamp connections.

The cross-sectional area of the clamping conductor is 0.5 ... 1.5 mm².

EG SERIES

The EG7 integral enclosure has a special status because it is only suited for the installation of 10 mm narrow relay couplers. EG7 clip-in base can be mounted on either the TS 32 or TS 35. An RS EG7 snap-in base is also available for the RST plug-in relay couplers.

The closed EG 7 enclosures are equipped with screw connections.

Conductors with the following cross-sectional areas can be connected:

- Integral enclosure EG 7: 0.5 ... 1.5 mm²
- Change-over contact RST: 0.5 ... 2.5 mm².

PLUGSERIES

1 change-over contact

Construction kit consists of

- Relay-socket for mounting-rail
- LED-indicator / RC-combination
- Retaining bracket
- Pluggable relay

Cross-connection of the coil connections and change-over contacts of the relay with pluggable cross-connection ZQV 2.5N

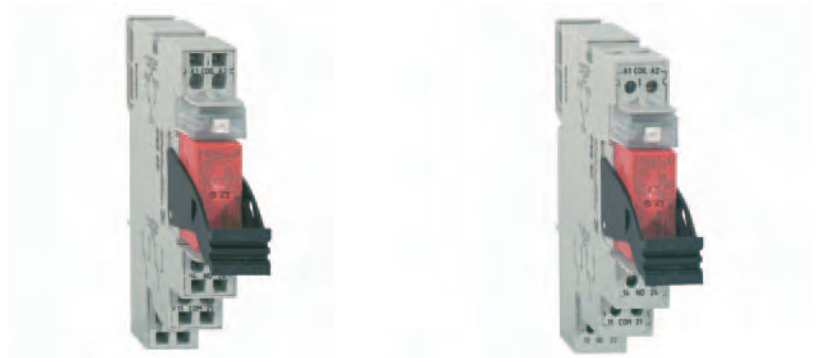

DC version

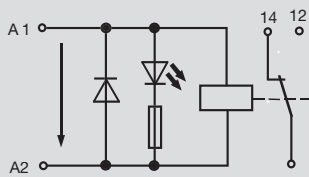

AC version

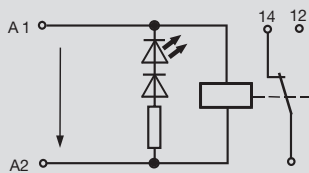

Output

Max. switching voltage AC/Continuous current	250V/10A
Min. switching power	10V/100mA
Response time / Release time	5.8ms/6.9ms
Contact base material	AgNi 90/10
Mechanical endurance	30x10 ⁶ switching cycles
Max. switching frequency at rated load	0.1Hz

Rated data

Status indicator/Free wheel diode/Reverse volt. prot.	LED green/Yes/not available
Ambient temp., fitted w. distance	-25 °C...+50 °C
Storage temperature	-40 °C...+50 °C
Climate	40°C/93% rel. humidity without condensation
Approvals	CE, cURus

Insulation coordinates (EN 50 178)

Standards	EN 50178
Rated voltage	250V
Impulse withstand voltage	6 kV
Creepage and clearance path input - output	>8mm
Overvoltage category	III
Pollution severity	2
Secure separation acc. to VDE 0106 Part 101	Yes

Dimensions

		Screw connection	Tension clamp connection
Clamping range (rating- / min. / max.)	mm ²	2.5 / 0.5 / 2.5	2.5 / 0.5 / 2.5
Length x width x height	mm	92.0 / 15.3 / 95.0	92.0 / 15.3 / 87.0

Information

Applications

K

Max. DC load breaking capacity

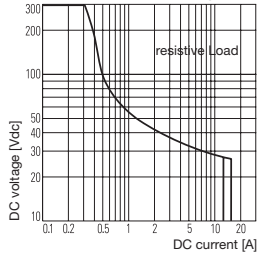

Electrical life

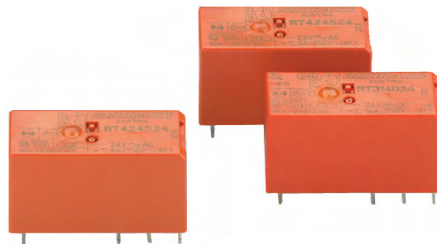
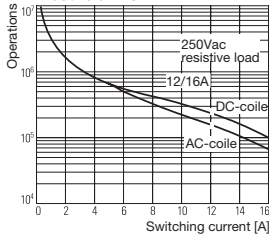

Coil operating range DC

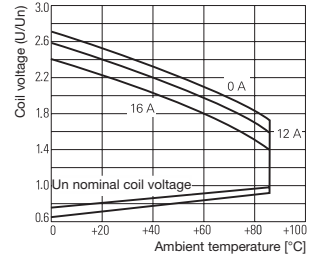

Coil operating range AC

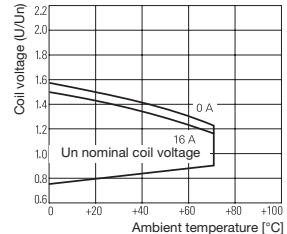

PLUGSERIES

1 change-over contact

Ordering data	12VDC 1CO	24VDC 1CO	115VDC 1CO	24VAC 1CO
Input				
Rated voltage	12 Vdc +/- 20 %	24 Vdc +/- 10 %	115 Vdc +/- 10 %	24 Vac +/- 10 %
Rated current AC				32mA
Rated current DC	33mA	16mA	3.5mA	
Power rating	400mW	400mW	400mW	0.75VA
Oper.-/drop-out volt. AC-coil				17V/3.6V
Oper.-/drop-out volt. DC-coil	8.4V/1.2V	16.8 V / 2.4 V	76 V / 11 V	
Pull-in curr./release curr. AC-coil				
Pull-in curr./release curr. DC-coil				
Ordering data Complete module				
Screw connection Type	PRS 12Vdc LD 1CO	PRS 24Vdc LD 1CO	PRS 115Vdc LD 1CO	PRS 24Vac LD 1CO
Order No.	8536471001	8530621001	8536510000	8536530000
Tension clamp connection Type	PRZ 12Vdc LD 1CO	PRZ 24Vdc LD 1CO	PRZ 115Vdc LD 1CO	PRZ 24Vac LD 1CO
Order No.	8536571001	8530691001	8536610000	8536651001
Ordering data Spare relay, pluggable				
Type	RCL 314012 12Vdc-Rel1U	RCL 314024 24Vdc-Rel1U	RCL 314110 110Vdc-Rel1U	RCL 315524 24Vac-Rel1U
Order No.	4058470000	4058480000	4058500000	4058510000
Information				
Ordering data	120VAC 1CO	230VAC 1CO		
Input				
Rated voltage	120 Vac +/- 10 %	230 Vac +/- 10 %		
Rated current AC	6.6mA	3.2mA		
Rated current DC				
Power rating	0.75VA	0.75VA		
Oper.-/drop-out volt. AC-coil	86.3V/17.3V	171 V / 34 V		
Oper.-/drop-out volt. DC-coil				
Pull-in curr./release curr. AC-coil				
Pull-in curr./release curr. DC-coil				
Ordering data Complete module				
Screw connection Type	PRS 120Vac LD 1CO	PRS 230Vac LD 1CO		
Order No.	8530641001	8530671001		
Tension clamp connection Type	PRZ 120Vac LD 1CO	PRZ 230Vac LD 1CO		
Order No.	8530710000	8530731001		
Ordering data Spare relay, pluggable				
Type	RCL 314615 115Vac-Rel1U	RCL 314730 230Vac-Rel1U		
Order No.	4058520000	4058540000		
Information				



PLUGSERIES

2 change-over contacts

Construction kit consists of

- Relay-socket for mounting-rail
- LED-indicator / RC-combination
- Retaining bracket
- Pluggable relay

Cross-connection of the coil connections and change-over contacts of the relay with pluggable cross-connection ZQV 2.5N



DC version

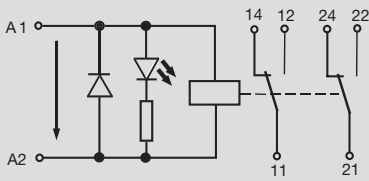

AC version

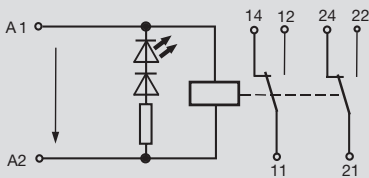

Output

Max. switching voltage AC/Continuous current	250V/10A
Min. switching power	10V/100mA
Response time / Release time	9ms/45ms
Contact base material	AgNi 90/10
Mechanical endurance	5x10 ⁶ switching cycles
Max. switching frequency at rated load	0.1Hz

Rated data

Status indicator/Free wheel diode/Reverse volt. prot.	LED green/No/
Ambient temp., fitted w. distance	-40 °C...+50 °C
Storage temperature	-40 °C...+50 °C
Climate	40°C/93% rel. humidity without condensation
Approvals	CE, cURus

Insulation coordinates (EN 50 178)

Standards	EN 50178
Rated voltage	250V
Impulse withstand voltage	6 kV
Creepage and clearance path input - output	>8mm
Overvoltage category	III
Pollution severity	2
Secure separation acc. to VDE 0106 Part 101	Yes

Dimensions

	Screw connection	Tension clamp connection
Clamping range (rating- / min. / max.)	mm ² 2.5 / 0.5 / 2.5	2.5 / 0.5 / 2.5
Length x width x height	mm 92.0 / 15.3 / 95.0	92.0 / 15.3 / 87.0

Information

Applications

K

Max. DC load breaking capacity

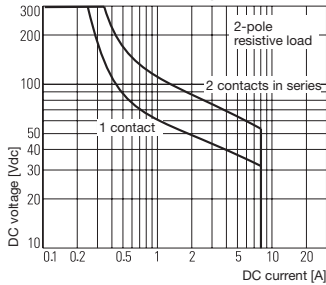

Electrical life

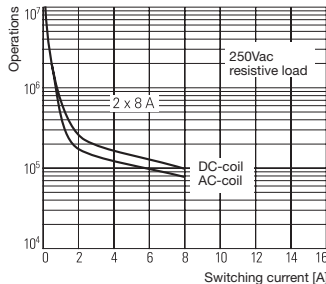

Coil operating range DC

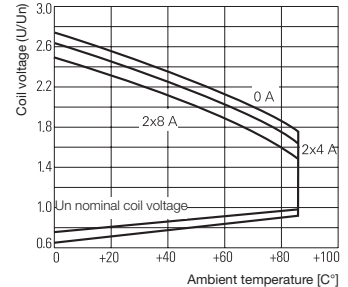

Coil operating range AC

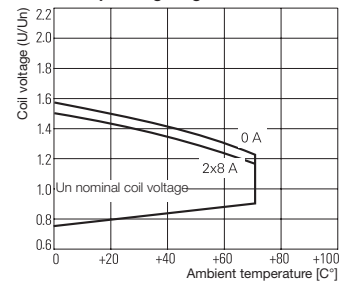

PLUGSERIES

2 change-over contacts

Ordering data	12VDC 2CO	24VDC 2CO	115VDC 2CO	24VAC 2CO
Input				
Rated voltage	12 Vdc +/- 20 %	24 Vdc +/- 10 %	115 Vdc +/- 10 %	24 Vac +/- 10 %
Rated current AC				32mA
Rated current DC	33mA	16mA	3.5mA	
Power rating	400mW	400mW	400mW	0.75VA
Oper./drop-out volt. AC-coil				17V/3.6V
Oper./drop-out volt. DC-coil	8.4 V / 1.2 V	16.8 V / 2.4 V	76 V / 11 V	
Pull-in curr./release curr. AC-coil				
Pull-in curr./release curr. DC-coil				
Ordering data Complete module				
Screw connection Type	PRS 12Vdc LD 2CO	PRS 24Vdc LD 2CO	PRS 115Vdc LD 2CO	PRS 24Vac LD 2CO
Order No.	8536501001	8530631001	8536520000	8536560000
Tension clamp connection Type	PRZ 12Vdc LD 2CO	PRZ 24Vdc LD 2CO	PRZ 115Vdc LD 2CO	PRZ 24Vac LD 2CO
Order No.	8536591001	8530701001	8536630000	8536681001
Ordering data Spare relay, pluggable				
Type	RCL 424012 12Vdc-Rel2U	RCL 424024 24Vdc-Rel2U	RCL 424110 110Vdc-Rel2U	RCL 424524 24Vac-Rel2U
Order No.	4058560000	4058570000	4058590000	4058600000
Information				
Ordering data	120VAC 2CO	230VAC 2CO		
Input				
Rated voltage	120 Vac +/- 10 %	230 Vac +/- 10 %		
Rated current AC	6.6mA	3.2mA		
Rated current DC				
Power rating	0.75VA	0.75VA		
Oper./drop-out volt. AC-coil	86.3V/17.3V	172.5V/34.5V		
Oper./drop-out volt. DC-coil				
Pull-in curr./release curr. AC-coil				
Pull-in curr./release curr. DC-coil				
Ordering data Complete module				
Screw connection Type	PRS 120Vac LD 2CO	PRS 230Vac LD 2CO		
Order No.	8530661001	8530681001		
Tension clamp connection Type	PRZ 120Vac LD 2CO	PRZ 230Vac LD 2CO		
Order No.	8530720000	8530741001		
Ordering data Spare relay, pluggable				
Type	RCL 424615 115Vac-Rel2U	RCL 424730 230Vac-Rel2U		
Order No.	4058610000	4058630000		
Information				

PLUGSERIES

2 change-over contacts with gold-plated contacts

Construction kit consists of

- Relay-socket for mounting-rail
- LED-indicator / RC-combination
- Retaining bracket
- Pluggable relay

Cross-connection of the coil connections and change-over contacts of the relay with pluggable cross-connection ZQV 2.5N



DC version

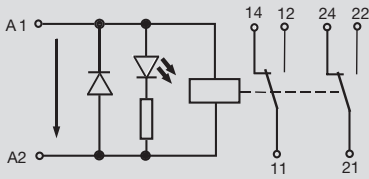

AC version

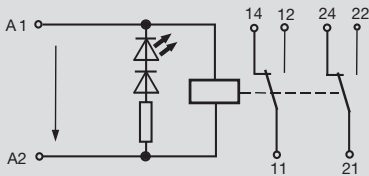

Output

Max. switching voltage AC/Continuous current	250V/10A
Min. switching power	5 V / 10 mA
Response time / Release time	9ms/45ms
Contact base material	AgNi 90/10
Mechanical endurance	5x10 ⁶ switching cycles
Max. switching frequency at rated load	0.1Hz

Rated data

Status indicator/Free wheel diode/Reverse volt. prot.	LED green/No/
Ambient temp., fitted w. distance	-40 °C...+50 °C
Storage temperature	-40 °C...+50 °C
Climate	40°C/93% rel. humidity without condensation
Approvals	CE, cURus

Insulation coordinates (EN 50 178)

Standards	EN 50178
Rated voltage	250V
Impulse withstand voltage	6 kV
Creepage and clearance path input - output	>8mm
Overvoltage category	III
Pollution severity	2
Secure separation acc. to VDE 0106 Part 101	Yes

Dimensions

	Screw connection	Tension clamp connection
Clamping range (rating- / min. / max.)	mm ² 2.5 / 0.5 / 2.5	2.5 / 0.5 / 2.5
Length x width x height	mm 92.0 / 15.3 / 95.0	92.0 / 15.3 / 87.0

Information

Ordering data

Input

Rated voltage	24 Vdc +/- 10 %
Rated current AC	
Rated current DC	16mA
Power rating	400mW
Oper.-/drop-out volt. AC-coil	
Oper.-/drop-out volt. DC-coil	16.8 V / 2.4 V
Pull-in curr./release curr. AC-coil	
Pull-in curr./release curr. DC-coil	

24VDC 2CO AU

120VAC 2CO AU

Rated voltage	120 Vac +/- 10 %
Rated current AC	6.6mA
Rated current DC	
Power rating	0.75VA
Oper.-/drop-out volt. AC-coil	86.3V/17.3V
Oper.-/drop-out volt. DC-coil	
Pull-in curr./release curr. AC-coil	
Pull-in curr./release curr. DC-coil	

230VAC 2CO AU

Rated voltage	230 Vac +/- 10 %
Rated current AC	3.2mA
Rated current DC	
Power rating	0.75VA
Oper.-/drop-out volt. AC-coil	172.5V/34.5V
Oper.-/drop-out volt. DC-coil	
Pull-in curr./release curr. AC-coil	
Pull-in curr./release curr. DC-coil	

K

Ordering data

Complete module

Screw connection	Type	24VDC 2CO AU	120VAC 2CO AU	230VAC 2CO AU	
	Type	PRS 24Vdc LD 2COAU	PRS 120VAC LD 2CO AU	PRS 230VAC LD 2CO AU	
	Order No.	8561760000	8595960000	8595990000	
Tension clamp connection	Type	PRZ 24Vdc LD 2CO AU	PRZ 120VAC LD 2COAU	PRZ 230VAC LD 2COAU	
	Order No.	8552440000	8575940000	8575950000	

Ordering data

Spare relay, pluggable

Screw connection	Type	24VDC 2CO AU	120VAC 2CO AU	230VAC 2CO AU	
	Type	RCL 425024 24Vdc-Rel2U	RCL 425615 115Vac-Rel2U	RCL 425730 230Vac-Rel2U	
	Order No.	4058580000	4058620000	4058640000	

Information

PLUGSERIES

Accessories

Schrack RP3SL

Relay for high switch-on current

Relay coupler

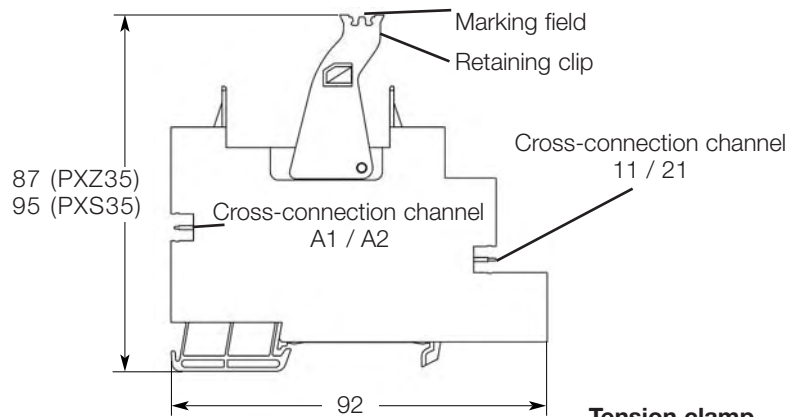

Technical data

Empty base	
Rated current	16 A
Rated voltage	250 V
Voltage resistance coil / contacts	> 4 kV
Protection	IP 20
Nominal cross-sectional area	2,5 mm ²
Stripping length	8 mm
	10 mm
Ambient temperature	-40°C ... +60°C
Flammability acc. to UL 94	V-0

Screw connection
Tension clamp connection

Order data

Empty base for assembly on mounting rail TS 35			
Screw connection	PXS35	10	8533771001
Tension clamp connection	PXZ35	10	8536691001

Retaining clip			
PRC	100	8536700000	

LED display with freewheel diode			
6 ... 24 Vdc	PLED 24 Vdc	20	8536710000
LED red, 6 ... 24 Vdc	PLED 24 Vdc rot	20	8611010000
48 ... 60 Vdc	PLED 48 Vdc	20	8536720000
115 Vdc	PLED 115 Vdc	20	8536730000
12 ... 24 Vac	PLED 24 Vac	20	8536750000
115 Vac	PLED 120 Vac	20	8536760000
230 Vac	PLED 230 Vac	20	8536780000
LED red, 230 Vac	PLED 230 Vac rot	20	8611000000
RC combination 120...230 VAC/DC	PLRC 200 nF/200Ω	20	8566530000

Plug-in cross-connectors				
2-pole	Black	ZQV 2.5N/4-2SW	60	1784270000
	Red	ZQV 2.5N/4-2RT	60	1784280000
	Blue	ZQV 2.5N/4-2BL	60	1784290000

Marking				
	10 x 5 mm	WS 10/5	200	1060860000
	15 x 5 mm	WS 15/5	96	1609880000

Tension clamp connection

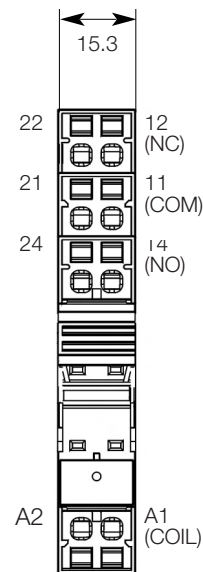

Screw connection

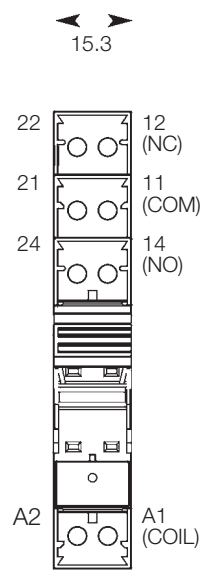

Operating control display

DC version

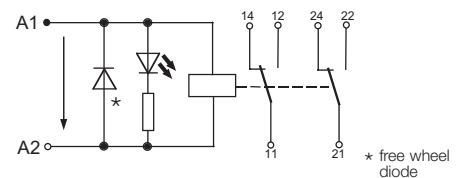

AC version

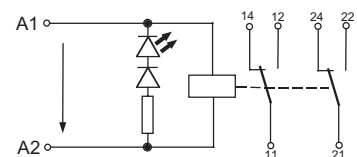

PLUGSERIES

Relay on plug-in base

Schrack RP3SL

- For high switch-on current



Technical data

No. and type of contacts	1 NOC
Contact material	AgSnO ₂
Switching current	25 A
Peak switch-on current	120 A / 20 ms
Switching voltage	250 V
Switching power	4 kVA
Min. switching current / switching power	
Nominal consumption	500 mW
Voltage strength / contact	4 kV
Operating voltage / release time:	DC coil typ. 8 / 2 ms
Bounce time NCC / NOC	typ. 2 ms
Mechanical service life	DC coil 30 x 10 ⁶ switching cycles

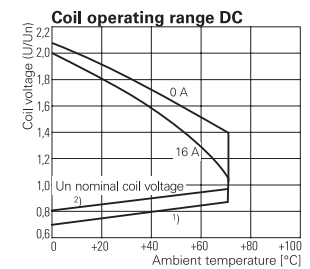
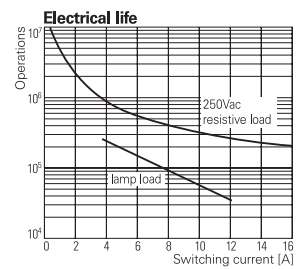

Other data	
Protection class	IP 40
Ambient temperature	DC coil -40°C ... +70°C
Weight	18 g
Approvals	SEV, UL, CSA, VDE

Contact service life	Load	Switching cycles	Regulation
	12 A, 250 V-, cosφ=1	3x10 ⁵	
	TV 8	25x10 ³	UL 508
	2500 W, 230 V-, Halogen lamps	>10 ⁴	
	1000 W, 250 V-, Neon lamps	2.3x10 ⁵	
	3000 W, 250 V-, Neon lamps	3.6x10 ⁴	
	1500 VA, Fluorescent tubes 163 μF	10 ⁴	

Order data

Pluggable relay	Type	Qty	Order no.
24 Vdc 1 NOC	RP3SL 24 Vdc 1NO	20	8588510000

Base for industrial relays

- Screw or tension clamp technology
- For connecting cross-sectional areas up to 1.5 mm²
- For double and quadruple change-over contact relays
- Insulation in accordance with VDE 0110
- Tension clamp connection
 - Minimum wiring workload
 - Double wiring of all terminals
 - Connections can be cross-connected
 - Separate arrangement of coil and contact connections

Wiring method for tension clamp connection

Place the specified screwdriver in the round tool opening next to the square wire opening

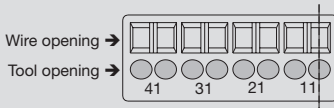

Technical data

Rated current
Rated voltage
Voltage strength coil / contacts
Creepage and clearance path input / output
Protection class
Nominal cross-sectional area
Stripping length
Ambient temperature
Combustibility acc. to UL 94
Approvals

PXZ4

Tension clamp



Rated current	5 A bei 70 °C with MY4 relay
Rated voltage	250 Vac
Voltage strength coil / contacts	2000 Vac
Creepage and clearance path input / output	2000 Vac
Protection class	IP 20
Nominal cross-sectional area	0.2...1.5 mm ² (doubled)
Stripping length	8 mm
Ambient temperature	max. 70 °C
Combustibility acc. to UL 94	V-1
Approvals	

PXS4

Screw connection



Rated current	5 A bei 70 °C with MY4 relay
Rated voltage	250 Vac
Voltage strength coil / contacts	2000 Vac
Creepage and clearance path input / output	2000 Vac
Protection class	IP 20
Nominal cross-sectional area	0.2...1.5 mm ²
Stripping length	8 mm
Ambient temperature	max. 70 °C
Combustibility acc. to UL 94	V-1
Approvals	

Order data

Empty base for mounting rail assembly TS 35	
Type	PXZ4

Type	Qty	Order no.
PXZ4	10	8598710000

Type	Qty	Order no.
PXS4	10	8614350000

Accessories

Retaining clip	
Relay, type: MY4	
Relay, type: PT5	

Type	Qty	Order no.
PXZ4-PIRC	50	8598610000
PT 28802	25	8572170000

Type	Qty	Order no.
PXS4-PIRC	100	8633920000

Marking	
for PXZ4-PIRC only	

Type	Qty	Order no.
WS PXZ4	100	8598630000

Type	Qty	Order no.

Cross-connector	
2-pole	Blue
	Red

Type	Qty	Order no.
ZQV PXZ4-bl	50	8611090000
ZQV PXZ4-rt	50	8611100000

Type	Qty	Order no.

Screwdriver	

Type	Qty	Order no.
SD	1	9009030000

Type	Qty	Order no.

Miniature power relay MY4

- Relay with 4 change-over contacts
- With DC or AC voltage coil
- Mechanical operating display
- Integrated LED for optical operating display
- Test button (blue = DC coil, red = AC coil)
- Cadmium-free contacts with 3 µm gold plating
- For plugging onto Weidmüller base PXS4 and PXS4

MY4 IN / MY4 IN1

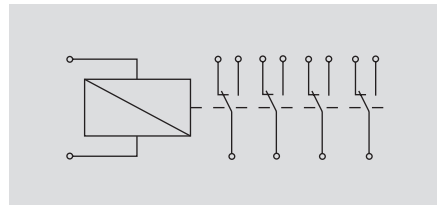
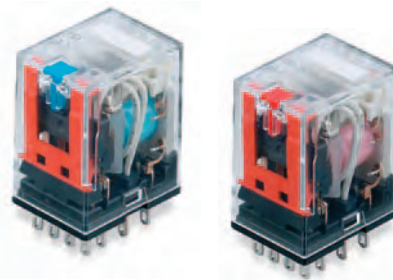

Technical data

Coil data	
Rated voltage	
Rated power	
Operating voltage/release voltage	
Contact data	
No. of contacts	
Contact material	
Rated current	
Switching voltage max.	DC coil / AC coil
Max. switching power AC	
Switching current	
Recommended min. load	
General data	
Flammability class acc. to UL 94	
Ambient temperature	
Mechanical service life	DC coil / AC coil
Response/release time	
Duration of bounce	
Weight	
Dimensions (width x height x length)	
Insulation	
Voltage strength coil-contact	
Insulation acc. to IEC 664 / VDE 0110 (1/89)	
Rated voltage / pollution severity / overvoltage category	
Insulation acc. to VDE 0110b (2/79)	
Insulation group/reference voltage	

DC coil	AC coil
12 / 24 / 110 V-	24 / 120 / 230 V~
Typically 0.9 W	Typically 1.0 VA
80 / 10 (% rated voltage)	80 / 30 (% rated voltage)
4 change-over contacts	
AgNi with 3µm Au plating	
4 x 5 A	
125 V- / 250 V~	
1250 VA	
4 x 5 A	
5 Vdc, 10 mA	
V-2	
-55...+70 °C	
>10x10 ⁷ / >50x10 ⁶	
20 / 20 ms	
max. 20 ms	
35 g	
21.5 x 36 x 28 mm	
2000 Vac	
240 V / 2 / II	
A250 / B125	

Order data

DC coil	
12 Vdc	
24 Vdc	
110 Vdc	
AC coil	
24 Vac	
120 Vac	
230 Vac	

Type	Qty	Order no.
MY4 IN1-12	10	8598660000
MY4 IN1-24	10	8598700000
MY4 IN1-110	10	8598640000
MY4 IN-24	10	8598690000
MY4 IN-120	10	8598650000
MY4 IN-230	10	8598670000

Other relays on request

Breaking capacity

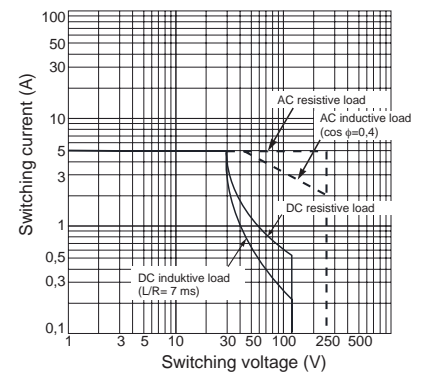

Lifetime (inductive load)

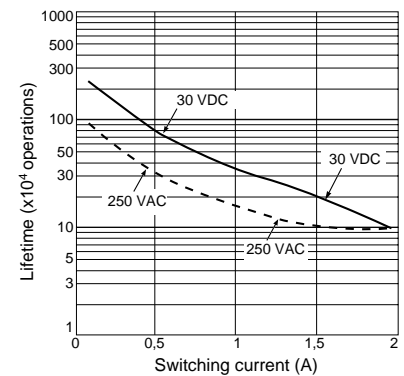

Lifetime (resistive load)

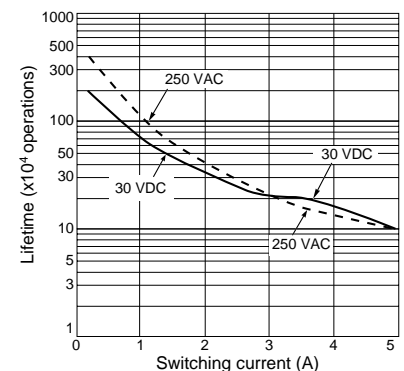

Miniature power relay PT 5

- Relay with 4 change-over contacts
- With DC or AC voltage coil
- Mechanical operating display
- Locking test button
- Cadmium-free contact material
- For plugging onto Weidmüller base PXZ4 with retaining clip PT 28802

PT 5

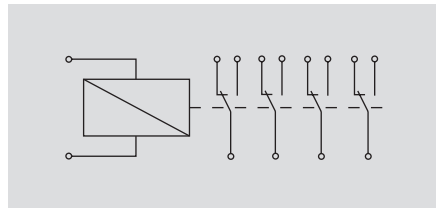

Technical data

Coil data	
Rated voltage	6...220 V-
Rated power	Typically 0.75 W
Operating voltage/release voltage	75 / 10 (% rated voltage)
Working range AC coil, 60 Hz at 70°C	90...110 % U _{rated}
Contact data	
No. of contacts	4 change-over contacts
Contact material	AgNi 90 / 10, AgNi 90 / 10 htv
Rated current	4 x 6 A
Switching voltage max.	250 Vac
Max. switching power AC	1500 VA
Switching current	4 x 6 A
Recommended min. load	24 V, 10 mA / 20 mV, 1 mA htv
General data	
Flammability class acc. to UL 94	V-0
Ambient temperature	-40...+70°C
Mechanical service life	> 30 x 10 ⁶ (DC coil), > 20 x 10 ⁶ (AC coil)
Response/release time	15 / 10 ms
Duration of bounce	5 ms
width x height x length	22.5 x 30 x 28 mm
Insulation	
Voltage strength coil-contact	2500 V _{eff}
Insulation acc. to IEC 664 / VDE 0110 (1/89)	
Rated voltage / pollution severity / overvoltage category	240 V / 2 / III
Insulation acc. to VDE 0110b (2/79)	
Insulation group/reference voltage	B / 250

DC coil	AC coil
Rated voltage	6...230 V~
Rated power	Typically 1.0 VA
Operating voltage/release voltage	80 / 10 (% rated voltage)
Working range AC coil, 60 Hz at 70°C	90...110 % U _{rated}
No. of contacts	4 change-over contacts
Contact material	AgNi 90 / 10, AgNi 90 / 10 htv
Rated current	4 x 6 A
Switching voltage max.	250 Vac
Max. switching power AC	1500 VA
Switching current	4 x 6 A
Recommended min. load	24 V, 10 mA / 20 mV, 1 mA htv
Flammability class acc. to UL 94	V-0
Ambient temperature	-40...+70°C
Mechanical service life	> 30 x 10 ⁶ (DC coil), > 20 x 10 ⁶ (AC coil)
Response/release time	15 / 10 ms
Duration of bounce	5 ms
width x height x length	22.5 x 30 x 28 mm
Voltage strength coil-contact	2500 V _{eff}
Insulation acc. to IEC 664 / VDE 0110 (1/89)	
Rated voltage / pollution severity / overvoltage category	240 V / 2 / III
Insulation acc. to VDE 0110b (2/79)	
Insulation group/reference voltage	B / 250

Order data

DC coil	
6 Vdc	PT 570006
12 Vdc	PT 570012
24 Vdc	PT 570024
48 Vdc	PT 570048
60 Vdc	PT 570060
115 Vdc	PT 570110
220 Vdc	PT 570220
AC coil	
6 Vac	PT 570506
12 Vac	PT 570512
24 Vac	PT 570524
48 Vac	PT 570548
60 Vac	PT 570560
115 Vac	PT 570615
230 Vac	PT 570730

Type	Qty	Order no.
PT 570006	10	8074650000
PT 570012	10	8054360000
PT 570024	10	1180700000
PT 570048	10	8074670000
PT 570060	10	8074680000
PT 570110	10	8074700000
PT 570220	10	8636230000
PT 570506	10	8074710000
PT 570512	10	8074730000
PT 570524	10	1181800000
PT 570548	10	1180900000
PT 570560	10	8074760000
PT 570615	10	1180800000
PT 570730	10	1181100000

Other relays on request

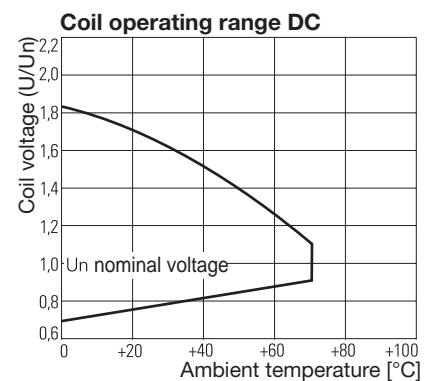
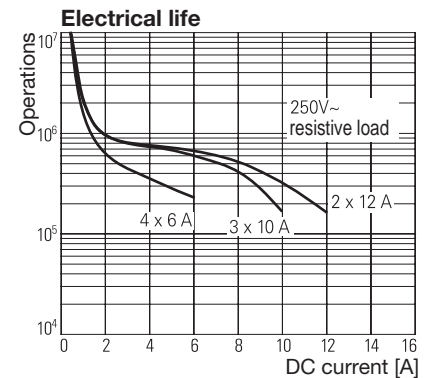
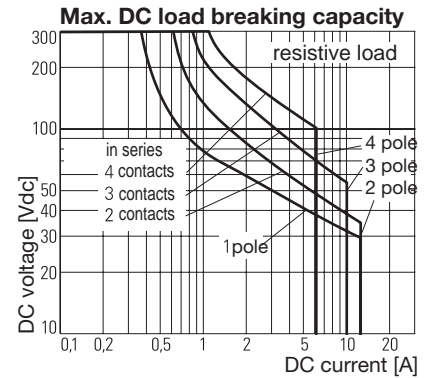

MICROSERIES

1 change-over contact

Module can be used as an universal interface between control and actuator for switching small and medium loads

- The pluggable cross-connection in input and output minimizes the effort to wire
- Width 6.1 mm
- Relay interchangeable, also with opto-couplers

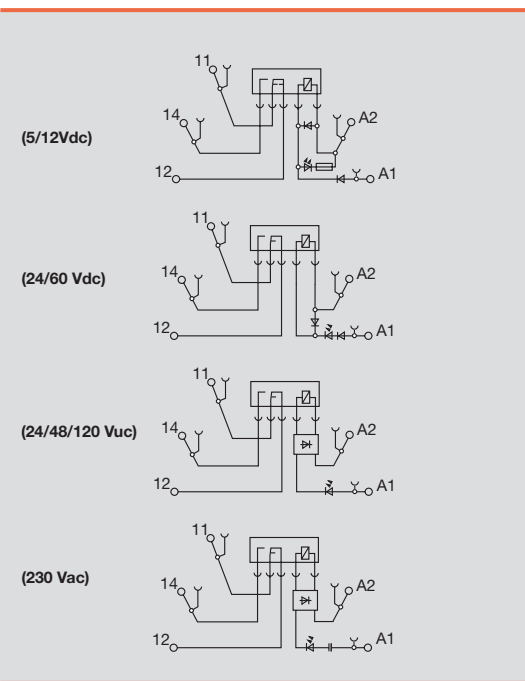
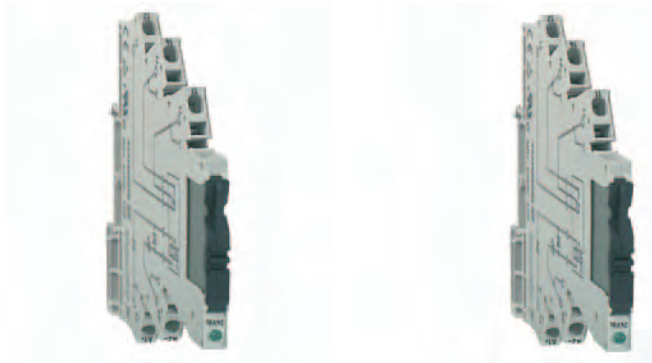

Output	
Max. switching voltage AC/Continuous current	250V/6A
Min. switching power	12V/100mA
Response time / Release time	6.2ms/3.9ms
Contact base material	AgSnO
Mechanical endurance	20x10^6 switching cycles
Max. switching frequency at rated load	0.1Hz
Rated data	
Status indicator/Free wheel diode/Reverse volt. prot.	LED green/Yes/available
Ambient temp., fitted w. distance	-25 °C...+50 °C
Storage temperature	-40 °C...+60 °C
Climate	40°C/93% rel. humidity without condensation
Approvals	CE, cURus
Insulation coordinates (EN 50 178)	
Standards	EN 50178
Rated voltage	300 V
Impulse withstand voltage	4 kV
Creepage and clearance path input - output	=>5.5mm
Overtoltage category	III
Pollution severity	2
Secure separation acc. to VDE 0106 Part 101	Yes

Dimensions	Screw connection	Tension clamp connection
Clamping range (rating- / min. / max.)	mm ² 2.5 / 0.5 / 4	1.5 / 0.5 / 2.5
Length x width x height	mm 93.0 / 6.1 / 92.0	94.0 / 6.1 / 91.0
Information		

Applications

K

DC-load breaking capacity

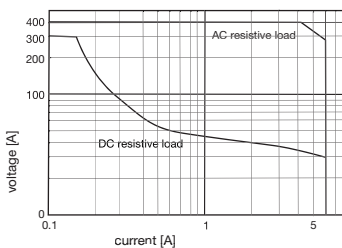

Derating curve

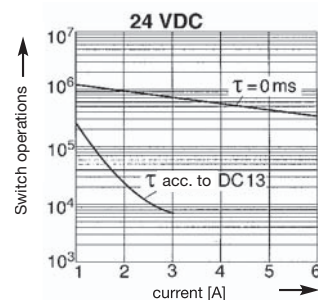
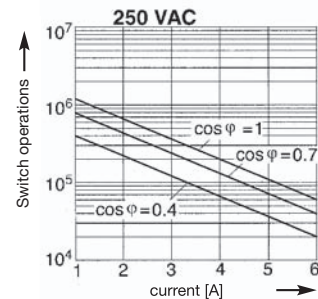
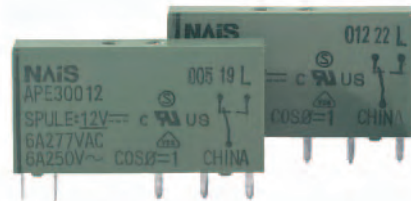
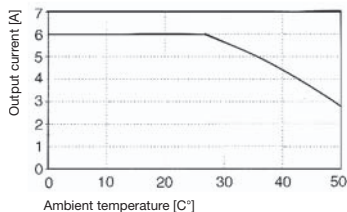

MICROSERIES

1 change-over contact

Ordering data	5VDC 1CO	12VDC 1CO	24VDC 1CO	24VUC 1CO
Input				
Rated voltage	5 Vdc +/- 20 %	12 Vdc +/- 20 %	24 Vdc +/- 20 %	24 Vuc +/- 10 %
Rated current AC				11mA
Rated current DC	38.5mA	17mA	6.6mA	6.4mA
Power rating	193mW	210mW	160mW	154mW
Oper./drop-out volt. AC-coil				15.8V/7V
Oper./drop-out volt. DC-coil	3.2V/1.6V	6.4V/2.5V	15.4V/6.5V	15.8V/7V
Pull-in curr./release curr. AC-coil				3.6mA/1.3mA
Pull-in curr./release curr. DC-coil	21.6mA/8mA	8.4mA/2.4mA	4mA/1.2mA	3.6mA/1.3mA
Ordering data Complete module				
Screw connection Type	MRS 5Vdc 1CO	MRS 12Vdc 1CO	MRS 24Vdc 1CO	MRS 24Vuc 1CO
Order No.	8556080000	8556070000	8533640000	8556050000
Tension clamp connection Type	MRZ 5Vdc 1CO	MRZ 12Vdc 1CO	MRZ 24VDC 1U	MRZ 24Vuc 1CO
Order No.	8556150000	8556140000	8533660000	8556120000
Ordering data Spare relay, pluggable				
Type	APE 30005V 05Vdc-Rel1U	APE 30012V 12Vdc-Rel1U	APE 30024V 24Vdc-Rel1U	APE 30024V 24Vdc-Rel1U
Order No.	4061580000	4061610000	4060120000	4060120000
Information				

Ordering data	48VUC 1CO	60VDC 1CO	120VUC 1CO	230VAC 1CO
Input				
Rated voltage	48 Vuc +/- 10 %	60 Vdc +/- 20 %	120 Vuc +10 %/ -15 %	230 Vac +/- 10 %
Rated current AC	5mA		3.5mA	7.6mA
Rated current DC	4mA	3.3mA	3.5mA	
Power rating	190mW	200mW	0.42VA	1.75VA
Oper./drop-out volt. AC-coil	29V/11V		71V/22V	103V/49V
Oper./drop-out volt. DC-coil	29V/11V	35V/11V	71V/22V	103V/49V
Pull-in curr./release curr. AC-coil	2.2mA/1.3mA		1.8mA/0.5mA	5mA/2.5mA
Pull-in curr./release curr. DC-coil	2.2mA/1.3mA	1.6mA/0.6mA	1.8mA/0.5mA	5mA/2.5mA
Ordering data Complete module				
Screw connection Type	MRS 48Vuc 1CO	MRS 60Vdc 1CO	MRS 120Vuc 1CO	MRS 230Vac 1CO
Order No.	8556040000	8556060000	8556030000	8556020000
Tension clamp connection Type	MRZ 48Vuc 1CO	MRZ 60Vdc 1CO	MRZ 120Vuc 1CO	MRZ 230Vac 1CO
Order No.	8556110000	8556130000	8556100000	8556090000
Ordering data Spare relay, pluggable				
Type	APE 30048V 48Vdc-Rel1U	APE 30060V 60Vdc-Rel1U	APE 30060V 60Vdc-Rel1U	APE 30024V 24Vdc-Rel1U
Order No.	4061620000	4061630000	4061630000	4060120000
Information				

K

MICROSERIES

1 change-over contact with gold-plated contact

Module can be used as an universal interface between control and actuator for switching small and medium loads

- The pluggable cross-connection in input and output minimizes the effort to wire
- Width 6.1 mm
- Relay interchangeable, also with opto-couplers

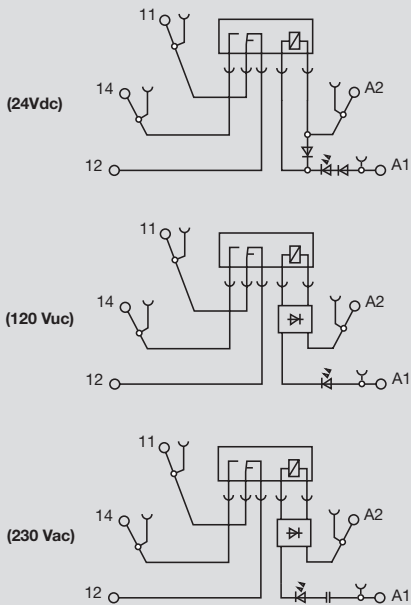

Output	
Max. switching voltage AC/Continuous current	250V/6A
Min. switching power	12V/10mA
Response time / Release time	6.6ms/5.8ms
Contact base material	AgSnO 5 #03BCm Au
Mechanical endurance	20x10 ⁶ switching cycles
Max. switching frequency at rated load	0.1Hz
Rated data	
Status indicator/Free wheel diode/Reverse volt. prot.	LED green/Yes/available
Ambient temp., fitted w. distance	-25 °C...+50 °C
Storage temperature	-40 °C...+60 °C
Climate	40°C/93% rel. humidity without condensation
Approvals	CE, cURus
Insulation coordinates (EN 50 178)	
Standards	EN 50178
Rated voltage	300 V
Impulse withstand voltage	4 kV
Creepage and clearance path input - output	=>5.5mm
Overtoltage category	III
Pollution severity	2
Secure separation acc. to VDE 0106 Part 101	Yes

Dimensions	Screw connection	Tension clamp connection
Clamping range (rating- / min. / max.)	mm ² 2.5 / 0.5 / 4	1.5 / 0.5 / 2.5
Length x width x height	mm 93.0 / 6.1 / 92.0	94.0 / 6.1 / 91.0

Information

Ordering data

Input

	24VDC 1CO 5uAU	230VAC 1CO 5uAU
Rated voltage	24 Vdc +/- 20 %	230 Vac +/- 10 %
Rated current AC		7.6mA
Rated current DC	6.6mA	
Power rating	160mW	1.75VA
Oper.-/drop-out volt. AC-coil		103V/49V
Oper.-/drop-out volt. DC-coil	15.4V/6.5V	103V/49V
Pull-in curr./release curr. AC-coil		5mA/2.5mA
Pull-in curr./release curr. DC-coil	4mA/1.2mA	5mA/2.5mA

Ordering data

Complete module

		24VDC 1CO 5uAU	230VAC 1CO 5uAU
Screw connection	Type	MRS 24Vdc 1CO 5uAu	MRS 230Vac 1CO 5uAu
	Order No.	8596060000	8596050000
Tension clamp connection	Type	MRZ 24Vdc 1CO 5uAu	MRZ 230Vac 1CO 5uAu
	Order No.	8596080000	8596070000

Ordering data

Spare relay, pluggable

		24VDC 1CO 5uAU	230VAC 1CO 5uAU
Spare relay, pluggable	Type	APE 30124V 24Vdc-Rel1U	APE 30124V 24Vdc-Rel1U
	Order No.	4061590000	4061590000

Information

MICROSERIES

Accessories

General data – MICROSERIES

Pluggable cross-connector

Type	No. of poles	Qty	Order no.
Yellow			
ZQV 4N / 2 GE	2	60	1758250000
ZQV 4N / 3 GE	3	60	1762630000
ZQV 4N / 4 GE	4	60	1762620000
ZQV 4N / 10 GE	10	20	1758260000
ZQV 4N / 41 GE	41	10	1758270000
Red			
ZQV 4N / 2 RT	2	60	1793950000
ZQV 4N / 3 RT	3	60	1793980000
ZQV 4N / 4 RT	4	60	1794010000
ZQV 4N / 10 RT	10	20	1794040000
ZQV 4N / 41 RT	41	10	1794070000
Blue			
ZQV 4N / 2 BL	2	60	1793960000
ZQV 4N / 3 BL	3	60	1793990000
ZQV 4N / 4 BL	4	60	1794020000
ZQV 4N / 10 BL	10	20	1794050000
ZQV 4N / 41 BL	41	10	1794080000
Black			
ZQV 4N / 2 SW	2	60	1793970000
ZQV 4N / 3 SW	3	60	1794000000
ZQV 4N / 4 SW	4	60	1794030000
ZQV 4N / 10 SW	10	20	1794060000
ZQV 4N / 41 SW	41	10	1794090000

Technical data

Clamping conductor		Tension clamp connection	Screw connection
Solid H07V-U	mm ²	0.5 ... 2.5	0.5 ... 4.0
Flexible H07V-K	mm ²	0.5 ... 2.5	0.5 ... 2.5
"f" with ferrule acc. to DIN 46 228 / 1	mm ²	0.5 ... 1.5	0.5 ... 1.5
"f" with ferrule with plastic collar	mm ²	0.5 ... 1.5	0.5 ... 1.5
Max. clamping range	mm ²	0.13 ... 2.5	0.13 ... 4.0
Plug gauge acc. to IEC 60-947-1	Size	A 2	A 3

General technical data

Rated torque	-	0,6
Continuous output current of the 2-pole cross-connector	A	10
Continuous output current of the multi-pole cross-connector A	10	10
Stripping length	mm	10
Protection class	IP 20	IP 20
Enclosure material	Wemid	Wemid
Flammability class acc. to UL 94	V-0	V-0
Rated current	A	6
Rated voltage	V	250

Other accessories

Type		Qty	Order no.
Marker			
WS 12/6	12 x 6 mm	200	1061160000
Labels, laser mark			
LM MT 300 15/6 ge	484 Labels / sheet	10	1686360000
Screwdriver			
SD 0.6 x 3.5 x 100		10	9008330000

Dimensional drawings

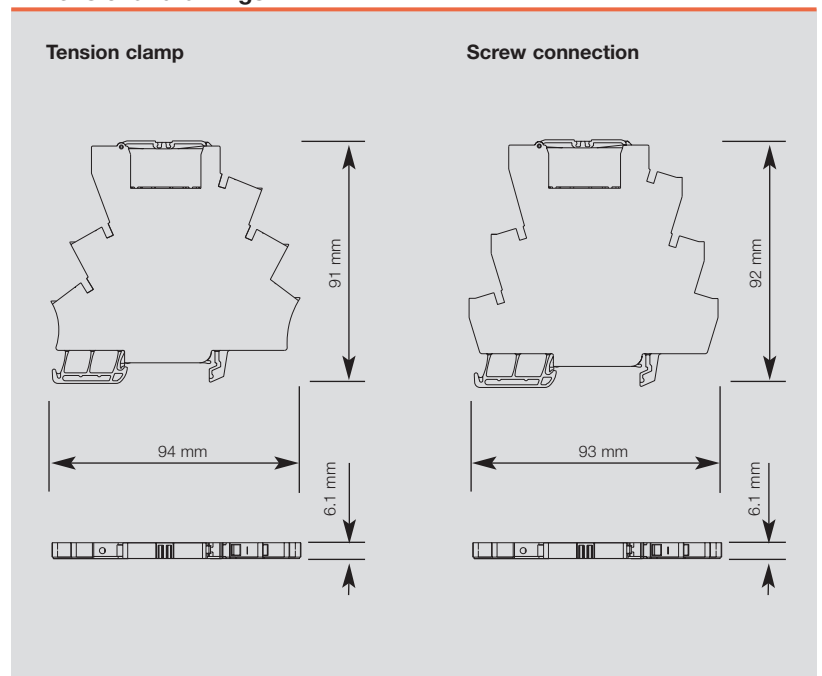

WAVESERIES

1 change-over contact

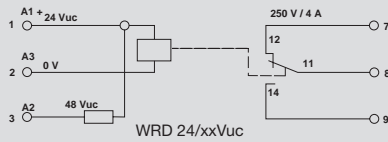
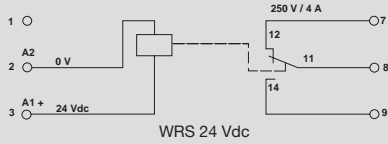
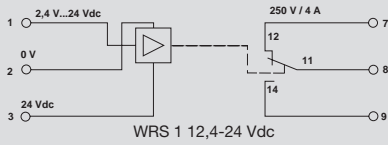

Output	
Max. switching voltage AC/Continuous current	250V/5A
Min. switching power	100mA/5Vdc
Response time / Release time	7ms/6ms
Contact base material	Ag alloy
Mechanical endurance	20x10^6 switching cycles
Max. switching frequency at rated load	0.1Hz
Rated data	
Status indicator/Free wheel diode/Reverse volt. prot.	LED green/Yes/available
Ambient temp., fitted w. distance	-25 °C...+50 °C
Storage temperature	-40 °C...+60 °C
Climate	40°C/93% rel. humidity without condensation
Approvals	UL / CSA
Insulation coordinates (EN 50 178)	
Standards	EN 50178
Rated voltage	300 V
Impulse withstand voltage	6 kV (1.2/50 μ)
Creepage and clearance path input - output	=>5.5mm
Overtoltage category	III
Pollution severity	2
Secure separation acc. to VDE 0106 Part 101	Yes

Dimensions	Screw connection	Tension clamp connection
Clamping range (rating- / min. / max.)	mm ² 1.5 / 0.5 / 2.5	
Length x width x height	mm 72.0 / 22.5 / 92.4	

Information

Applications

Mounted horizontally

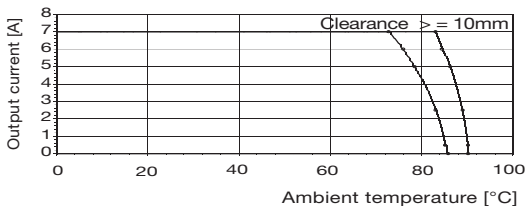

K

WAVESERIES

1 change-over contact

Ordering data	2.4-24VDC 1CO	24VDC 1CO	24/48VUC 1CO	24/60VUC 1CO
Input				
Rated voltage	2.4...24 Vdc +/- 10 %	24 Vdc +/- 10 %	24 Vuc // 48 Vuc, +/- 10 %	24 Vuc // 60 Vuc, +/- 10 %
Rated current AC			approx. 14mA	approx. 11mA
Rated current DC	4.6mA	9mA	14 mA	approx. 10mA
Power rating	200 mW	220mW	0.35VA(W) // 0.5VA(W)	0.22W / 0.34VA // 0.6W / 0.7VA
Oper.-/drop-out volt. AC-coil			16 V/9.5 V // 29 V/15 V	16 V/9.5 V // 31 V/20 V
Oper.-/drop-out volt. DC-coil	1.9 V	16 V/7.5 V	16 V/9.5 V // 29 V/15 V	15 V/8.5V // 34 V/15 V
Pull-in curr./release curr. AC-coil			9 mA/4.5 mA // 8.3mA/4.1mA	5.6mA/2.3mA // 5.6mA/2.1mA
Pull-in curr./release curr. DC-coil	3.88mA	5.7 mA/2.2 mA	9 mA/4.5 mA // 8.3mA/4.1mA	5.8 mA/3.9 mA // 5.6 mA/3.4 mA
Ordering data Complete module				
Screw connection Type	WRS1 2.4-24VDC 1U	WRS1 24VDC 1U	WRS1 24/48VUC 1U	WRS1 24/60VUC 1U
Order No.	8275320000	8275350000	8286280000	8418210000
Tension clamp connection Type				
Order No.				
Ordering data Spare relay, pluggable				
Type				
Order No.				
Information				
Ordering data	24/115VUC 1CO	24VUC/230VAC 1CO		
Input				
Rated voltage	24 Vuc // 115 Vuc, +/- 10 %	24 Vuc // 230 Vac, +/- 10 %		
Rated current AC	approx. 11mA	approx. 15mA		
Rated current DC	approx. 10mA	14mA (24Vdc)		
Power rating	0.22W / 0.34VA // 1.2W / 1.3VA	0.34VA / 0.32W // 3.5VA		
Oper.-/drop-out volt. AC-coil	15 V/12 V // 60 V/34 V	13 V/9 V // 115 V/66 V		
Oper.-/drop-out volt. DC-coil	16V/8.5V // 64V/26V	13 V/9 V (24Vdc)		
Pull-in curr./release curr. AC-coil	5.8mA/3.9mA // 5.5mA/3mA	7.5 mA/4.7 mA // 7.4 mA/4.3 mA		
Pull-in curr./release curr. DC-coil	5.6mA/2.3mA // 5.7mA/2.2mA	7.5 mA/4.7 mA		
Ordering data Complete module				
Screw connection Type	WRS1 24/115VUC 1U	WRS1 24VUC/230VAC 1U		
Order No.	8418220000	8418230000		
Tension clamp connection Type				
Order No.				
Ordering data Spare relay, pluggable				
Type				
Order No.				
Information				

WAVESERIES

2 NO contacts

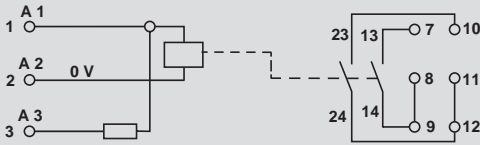
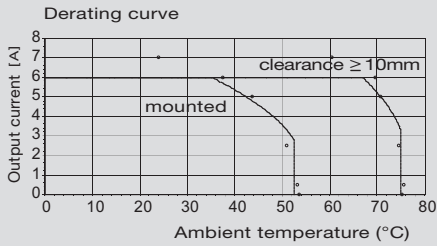

Output	
Max. switching voltage AC/Continuous current	250V/5A
Min. switching power	100mA/5Vdc
Response time / Release time	5ms/6ms
Contact base material	AgSnO2
Mechanical endurance	50x10^6 switching cycles
Max. switching frequency at rated load	0.1Hz
Rated data	
Status indicator/Free wheel diode/Reverse volt. prot.	LED green/Yes/available
Ambient temp., fitted w. distance	-25 °C...+50 °C
Storage temperature	-40 °C...+60 °C
Climate	40°C/93% rel. humidity without condensation
Approvals	UL / CSA
Insulation coordinates (EN 50 178)	
Standards	EN 50178
Rated voltage	300 V
Impulse withstand voltage	6 kV (1.2/50 µ)
Creepage and clearance path input - output	=>8mm
Overvoltage category	III
Pollution severity	2
Secure separation acc. to VDE 0106 Part 101	Yes

Dimensions	Screw connection	Tension clamp connection
Clamping range (rating- / min. / max.)	mm² 1.5 / 0.5 / 2.5	
Length x width x height	mm 92.4 / 22.5 / 112.4	

Information

Ordering data

Input	12/24VDC 2A	24/48VUC 2A	115VUC/230VAC 2A	
Rated voltage	12 Vdc // 24 Vdc, +/- 10 %	24 Vuc // 48 Vuc, +/- 10 %	115 Vuc // 230 Vac, +/- 10 %	
Rated current AC		approx. 11mA	approx. 10mA	
Rated current DC	approx. 20mA	approx. 8.5mA	9mA (115Vdc)	
Power rating	0.24W // 0.5W	0.17W / 0.21VA // 0.4W / 0.48VA	1VA / 0.9W // 2.5VA	
Oper.-/drop-out volt. AC-coil		13.5 V / 9 V // 24 V/16 V	58 V / 22 V // 110 V/40 V	
Oper.-/drop-out volt. DC-coil	7.5 V / 3.5 V // 14.5 V/6.1 V	16 V / 7.8 V // 28 V/12 V	54 V / 20 V (115Vdc)	
Pull-in curr./release curr. AC-coil		4.4 mA/2.7 mA // 4.3 mA/2.6 mA	4.8 mA/1.7 mA V // 5 mA/2 mA	
Pull-in curr./release curr. DC-coil	10 mA/4.2 mA // 10 mA/4 mA	4.3 mA/1.6 mA // 4.4 mA/1.6 mA	4 mA/2 mA	

Ordering data Complete module

Screw connection	Type	12/24VDC 2A	24/48VUC 2A	115VUC/230VAC 2A	
Order No.		WRS2 12/24VDC 2A	WRS2 24/48VUC 2A	WRS2 115VUC/230VAC 2A	
		8418240000	8418250000	8418260000	
Tension clamp connection	Type				
Order No.					

Ordering data Spare relay, pluggable

Type	12/24VDC 2A	24/48VUC 2A	115VUC/230VAC 2A	
Order No.				

Information

--	--	--	--	--

WAVESERIES

1 NC contact / 1 NO contact



Relay coupler

Derating curve

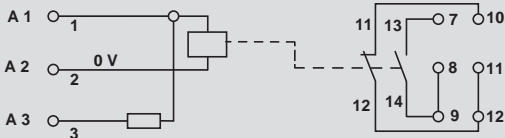
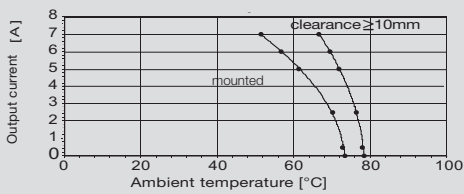

Output

Max. switching voltage AC/Continuous current	250V/5A
Min. switching power	100mA/5V
Response time / Release time	7ms/5ms
Contact base material	AgSnO2
Mechanical endurance	50x10^6 switching cycles
Max. switching frequency at rated load	0.1Hz

Rated data

Status indicator/Free wheel diode/Reverse volt. prot.	LED green/Yes/available
Ambient temp., fitted w. distance	-25 °C...+50 °C
Storage temperature	-40 °C...+60 °C
Climate	40°C/93% rel. humidity without condensation
Approvals	UL / CSA

Insulation coordinates (EN 50 178)

Standards	EN 50178
Rated voltage	300 V
Impulse withstand voltage	6 kV (1.2/50 µ)
Creepage and clearance path input - output	=>8mm
Overtoltage category	III
Pollution severity	2
Secure separation acc. to VDE 0106 Part 101	Yes

Dimensions

	Screw connection	Tension clamp connection
Clamping range (rating- / min. / max.)	mm² 1.5 / 0.5 / 2.5	
Length x width x height	mm 92.4 / 22.5 / 112.4	

Information

Ordering data

Input

Rated voltage	12 Vdc // 24 Vdc, +/- 10 %
Rated current AC	
Rated current DC	approx. 20mA
Power rating	0.24W // 0.5W
Oper.-/drop-out volt. AC-coil	
Oper.-/drop-out volt. DC-coil	7.5 V / 3.5 V // 14.5 V / 6.1 V
Pull-in curr./release curr. AC-coil	
Pull-in curr./release curr. DC-coil	10 mA / 4.2 mA // 10 mA / 4 mA

12/24VDC 1A 1R

24/48VUC 1A1R

Rated voltage	24 Vuc // 48 Vuc, +/- 10 %
Rated current AC	approx. 11mA
Rated current DC	approx. 8.5mA
Power rating	0.17W / 0.21VA // 0.4W / 0.48VA
Oper.-/drop-out volt. AC-coil	13.5 V / 9 V // 24 V / 16 V
Oper.-/drop-out volt. DC-coil	13.5 V / 9 V // 24 V / 16 V
Pull-in curr./release curr. AC-coil	4.4 mA / 2.7 mA // 4.3 mA / 1.6 mA
Pull-in curr./release curr. DC-coil	4.3 mA / 1.6 mA // 4.4 mA / 1.6 mA

115VUC/230VAC 1A 1R

Rated voltage	115 Vuc // 230 Vac, +/- 10 %
Rated current AC	approx. 10mA
Rated current DC	9mA (115Vdc)
Power rating	1VA / 0.9W // 2.5VA
Oper.-/drop-out volt. AC-coil	58 V / 22 V // 110 V / 40 V
Oper.-/drop-out volt. DC-coil	54 V / 20 V (115Vdc)
Pull-in curr./release curr. AC-coil	4.8 mA / 1.7 mA // 5 mA / 2 mA
Pull-in curr./release curr. DC-coil	4 mA / 1.6 mA

Ordering data

Complete module

Screw connection	Type	WRS2 12/24VDC 1A1R
	Order No.	8418270000
Tension clamp connection	Type	
	Order No.	

Screw connection	Type	WRS2 24/48VUC 1A1R
	Order No.	8418280000

Screw connection	Type	WRS2 115VUC/230VAC 1A1R
	Order No.	8418290000

Ordering data

Spare relay, pluggable

	Type	
	Order No.	

Information

K

WAVESERIES

2 change-over contacts

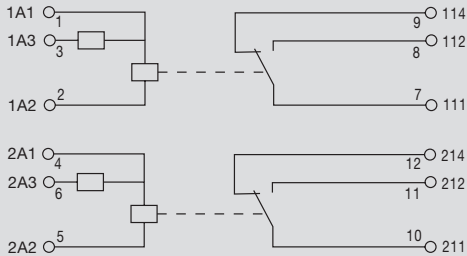
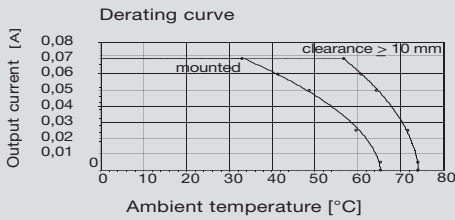

Output	
Max. switching voltage AC/Continuous current	250V/5A
Min. switching power	100mA/5Vdc
Response time / Release time	6ms/10ms
Contact base material	Ag alloy
Mechanical endurance	20x10^6 switching cycles
Max. switching frequency at rated load	0.1Hz
Rated data	
Status indicator/Free wheel diode/Reverse volt. prot.	LED green/Yes/available
Ambient temp., fitted w. distance	-25 °C...+50 °C
Storage temperature	-40 °C...+60 °C
Climate	40°C/93% rel. humidity without condensation
Approvals	UL / CSA
Insulation coordinates (EN 50 178)	
Standards	EN 50178
Rated voltage	300 V
Impulse withstand voltage	6 kV (1.2/50 μ)
Creepage and clearance path input - output	=>5.5mm
Overtoltage category	III
Pollution severity	2
Secure separation acc. to VDE 0106 Part 101	Yes

Dimensions	Screw connection	Tension clamp connection
Clamping range (rating- / min. / max.)	mm²	1.5 / 0.5 / 2.5
Length x width x height	mm	92.4 / 22.5 / 112.4

Information

Ordering data

Input

Rated voltage	12 Vdc // 24 Vdc, +/- 10 %
Rated current AC	
Rated current DC	approx. 23mA
Power rating	0.26W // 0.53W
Oper.-/drop-out volt. AC-coil	
Oper.-/drop-out volt. DC-coil	8.5 V / 3 V // 15 V/4.8 V
Pull-in curr./release curr. AC-coil	
Pull-in curr./release curr. DC-coil	15.2 mA/5.7 mA // 15.3 mA/5.6 mA

12/24VDC 2CO

24/48VUC 2CO

24VUC/230VAC 2CO

Rated voltage	24 Vuc // 48 Vuc, +/- 10 %	24 Vuc // 230 Vac, +/- 10 %
Rated current AC	approx. 15mA	approx. 15mA
Rated current DC	14 mA	14mA (24Vdc)
Power rating	0.35VA(W) // 0.7VA(W)	0.35W // 3.45VA
Oper.-/drop-out volt. AC-coil		13 V/9 V // 115 V/66 V
Oper.-/drop-out volt. DC-coil	16V/9.5V // 29V/15V	13 V/9 V (24Vdc)
Pull-in curr./release curr. AC-coil	9 mA/4.5 mA // 8.3mA/4.1mA	7.5 mA/4.7 mA // 7.4 mA/4.3 mA
Pull-in curr./release curr. DC-coil	9 mA/4.5 mA // 8.3mA/4.1mA	7.5 mA/4.7 mA

Ordering data

Complete module

Screw connection	Type	Order No.
	WRS2 12/24VDC 2U	8418300000
	WRS2 24/48VUC 2U	8418310000
	WRS2 24VUC/230VAC 2U	8418320000

Ordering data

Spare relay, pluggable

Type	Order No.

Information

WAVESERIES

3 NO contacts

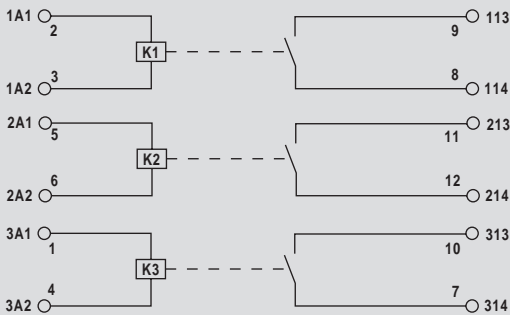
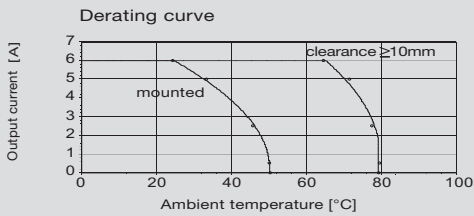

Output	
Max. switching voltage AC/Continuous current	250V/4A
Min. switching power	12V/10mA
Response time / Release time	5ms/21ms
Contact base material	AgSnO2
Mechanical endurance	20x10^6 switching cycles
Max. switching frequency at rated load	0.1Hz
Rated data	
Status indicator/Free wheel diode/Reverse volt. prot.	LED green/No/hot available
Ambient temp., fitted w. distance	-25 °C...+50 °C
Storage temperature	-40 °C...+60 °C
Climate	40°C/93% rel. humidity without condensation
Approvals	UL / CSA
Insulation coordinates (EN 50 178)	
Standards	EN 50178
Rated voltage	300 V
Impulse withstand voltage	6 kV (1.2/50 µ)
Creepage and clearance path input - output	=>5.5mm
Overvoltage category	III
Pollution severity	2
Secure separation acc. to VDE 0106 Part 101	Yes

Dimensions	Screw connection	Tension clamp connection
Clamping range (rating- / min. / max.)	mm²	1.5 / 0.5 / 2.5
Length x width x height	mm	92.4 / 22.5 / 112.4

Information

Ordering data

Input	24VUC 3A	230VAC 3A		
Rated voltage	24 Vuc +/- 10 %	230 Vac +/- 10 %		
Rated current AC	10.4mA	10.3mA		
Rated current DC	10.5mA			
Power rating	0.3VA // 0.25W	2.4VA		
Oper.-/drop-out volt. AC-coil	12.8 V / 5 V	207V/207V/207V		
Oper.-/drop-out volt. DC-coil	12.8 V / 5 V			
Pull-in curr./release curr. AC-coil	6.6 mA / 2.1 mA	9mA		
Pull-in curr./release curr. DC-coil	6.5 mA / 1.4 mA			

Ordering data Complete module

Screw connection	Type	24VUC 3A	230VAC 3A		
Order No.		WRS2 24VUC 3A	WRS2 230VAC 3A		
		8418330000	8418340000		
Tension clamp connection	Type				
Order No.					

Ordering data Spare relay, pluggable

Type	24VUC 3A	230VAC 3A		
Order No.				

Information

--	--	--	--	--



RS-SERIES / RS 30

1 NCC, 1 NOC
or 1 change-over contact

RS 30

Screw connection

1 NOC
1 NCC



1 change-over contact



RS 30

Isolating plug with screw connection

1 NOC
1 NCC



1 change-over contact

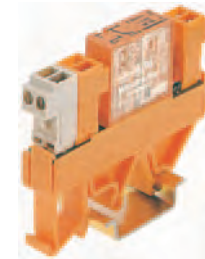

Technical data

Input voltage 5...60 V ± 10 %; 115 V/230 V + 5 % - 15%

Nominal consumption - (W)
Nominal consumption ~ (VA)
Release current of relay (at 20°C)
Release current of relay (at 20°C)
Pick-up current
Output voltage max.
Continuous current

5 VTTL	12 V~	24 V~	24 V≅	48 V~	48 V≅	60 V~	115 V~	115 V~	230 V~ ²⁾	240 V~
0.45 W ¹⁾	0.45 W	0.45 W	0.45 W	0.45 W	0.45 W	0.45 W	-	0.82 W	-	-
-	-	-	0.7 VA	-	0.6 VA	-	0.8 VA	-	0.8 VA	1.2 VA
-	3 mA	3 mA	2.5 mA~	2 mA	2.5 mA~	1 mA~	-	2 mA~	-	0.5 mA~
-	-	-	3.5 mA~	-	4.5 mA~	-	1 mA~	-	1 mA~	1 mA~
-	-	12 mA	-	10 mA	-	-	6 mA	4.3 mA	-	-
250 V	250 V	250 V	250 V	250 V	250 V	250 V	250 V	250 V	250 V	250 V
5 A	6 A	6 A	6 A	6 A	5 A	5 A	5 A	5 A	3 A	3 A

Derating curve
a = arranged on mounting rail in horizontal row without spacing
b = arranged on mounting rail in horizontal row with 20 mm spacing



Constant current

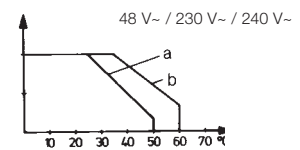
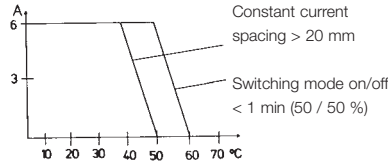

Switch-on current
Switch-on power under ohmic load
Min. switching power/switching current
Duration of bounce
Typical switching times
-, Pick-up delay
-, Release delay
Max. switching frequency
Contact material
Service life, mechanical
-, 24 V-, 1A ohmic load
-, 230 V-, 3A, ohmic load
Storage temperature
Ambient temperature, arranged on mounting rail
-, in horizontal row without spacing
-, in horizontal row with > 20 mm spacing

8 A
2000 VA / 100 W
250 mW / 10 mA
≤ 3 ms
≤ 8 ms
≤ 7 ms
70 Hz
AgNi, gold-flashed
>10 ⁷ switching cycles
> 5 x 10 ⁵ switching cycles
>7 x 10 ⁵ switching cycles
-40 °C...+60 °C
-25 °C...+40 °C
-25 °C...+50 °C

Insulation coordination acc. to EN 50 178

Overvoltage category
Pollution severity

III
2

Dimensions

Mounting width
Length (at right angles to mounting rail)
Height (with TS 32 / TS 35 x 7.5)

11.2 mm NOC / NCC, 25 mm change-over contact
70 mm (74 mm BL/SL version)
56 mm / 51.5 mm

¹⁾ Rated consumption of auxiliary voltage 24 V~.
²⁾ 230 V~ on request

RS 30

Screw connection

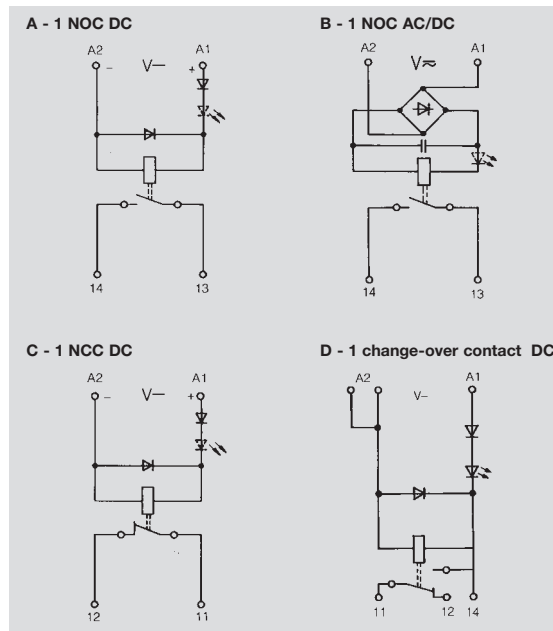

RS 30

Isolating plug with screw connection

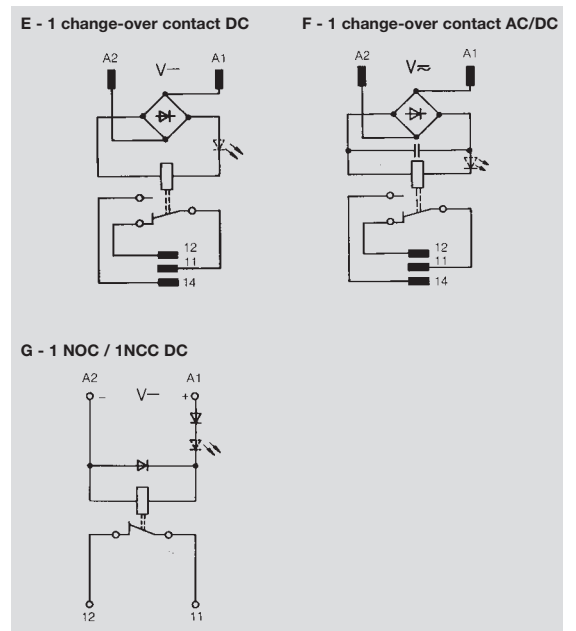

Order data

Mail-line wiring diagram	
Input voltage	Function display
5 V ₋ , TTL	without
12 V ₋	without LED red
24 V ₋	without LED green LED red
24 V _≈	without LED green LED red
48 V ₋	LED green LED red
48 V _≈	without LED green
60 V ₋	without LED green LED red
115 V ₋	without LED green LED red
115 V ₋	without LED green LED red
230 V ₋	without LED green LED red
240 V ₋	without LED green LED red

A	B	C	D
NOC	NOC	NCC	change-over contact
1129421001		1129521001	
1101661001		1100961001	
1101611001		1100911001	1181511001
1101621001		1100921001	1181521001
	1101761001		
	1101711001		
	1101721001		
1101811001			
1101821001			
	1101911001		
1102061001			
1102011001			
1155161001		1155261001	
1155111001		1155211001	
1155121001		1155221001	
	1102161001		
	1102111001		
	1102121001		
	1102261001		
	1102211001		
	1102221001		
	1128561001		
	1128511001		
	1128521001		

E	F	G	G
change-over contact	change-over contact	NOC	NCC
		1167760000	1167660000
	1129660000		
1100260000			
1100210000			
1100220000			
	1100360000		
1100410000			
1100420000			
	1100560000		
1100620000			
	1100760000		
	1100860000		

RS-SERIES - RS 31

1 change-over contact

- For high switching power
- Suitable to switch inductive loads

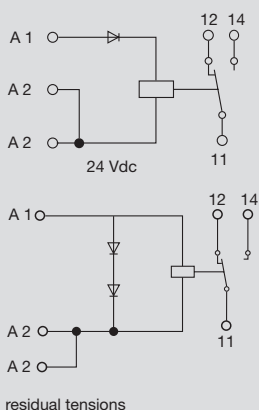
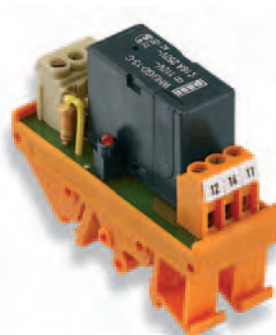

Output

Max. switching voltage AC/Continuous current	250V/16A
Min. switching power	1W
Response time / Release time	9ms/10ms
Contact base material	AgCdO
Mechanical endurance	3x10 ⁷ switching cycles
Max. switching frequency at rated load	0.1Hz

Rated data

Status indicator/Free wheel diode/Reverse volt. prot.	LED green/Yes/available
Ambient temp., fitted w. distance	-25 °C...+40 °C
Storage temperature	-40 °C...+60 °C
Climate	40°C/93% rel. humidity without condensation
Approvals	CE

Insulation coordinates (EN 50 178)

Standards	EN 50178
Rated voltage	250V
Impulse withstand voltage	6 kV
Creepage and clearance path input - output	3mm
Overvoltage category	III
Pollution severity	2
Secure separation acc. to VDE 0106 Part 101	No

Dimensions

	Screw connection	Tension clamp connection
Clamping range (rating- / min. / max.)	mm ² 2.5 / 0.5 / 4	
Length x width x height	mm 70.0 / 25.0 / 58.0	

Information

Applications

Derating curve

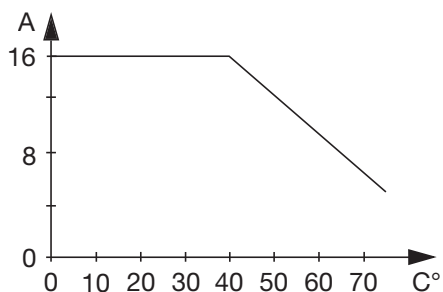

K

RS-SERIES - RS 31

1 change-over contact

Ordering data	24VDC 1CO	48VDC 1CO	115V DC 1CO	115VAC 1CO
Input				
Rated voltage	24 Vdc +/- 10 %	48 Vdc +/- 10 %	115 Vdc + 5 / - 15%	115 Vac +5 %/ -15 %
Rated current AC				8mA
Rated current DC	40mA	20mA	8mA	
Power rating	1W	1W	1W	1VA
Oper./drop-out volt. AC-coil				98V
Oper./drop-out volt. DC-coil	21.5V	43V	98V	
Pull-in curr./release curr. AC-coil				-/1.5mA
Pull-in curr./release curr. DC-coil	-/11.5mA	-/13.5mA	-/5.5mA	
Ordering data Complete module				
Screw connection Type	RS 31 24VDC LD LP 1U	RS 31 48VDC LD 1U LP	RS 31 115VDC LD LP 1U	RS 31 115VAC LD LP 1U
Order No.	1128311001	1150761001	1150361001	1150461001
Tension clamp connection Type				
Order No.				
Ordering data Spare relay, pluggable				
Type				
Order No.				
Information				
Ordering data	230VAC 1CO			
Input				
Rated voltage	230 Vac + 5 / - 15%			
Rated current AC	4.5mA			
Rated current DC				
Power rating	1VA			
Oper./drop-out volt. AC-coil	195V			
Oper./drop-out volt. DC-coil				
Pull-in curr./release curr. AC-coil	-/2.2mA			
Pull-in curr./release curr. DC-coil				
Ordering data Complete module				
Screw connection Type	RS 31 230VAC LD LP 1U			
Order No.	1128461001			
Tension clamp connection Type				
Order No.				
Ordering data Spare relay, pluggable				
Type				
Order No.				
Information				



RS-SERIES - RS 32

2 change-over contacts, DC input

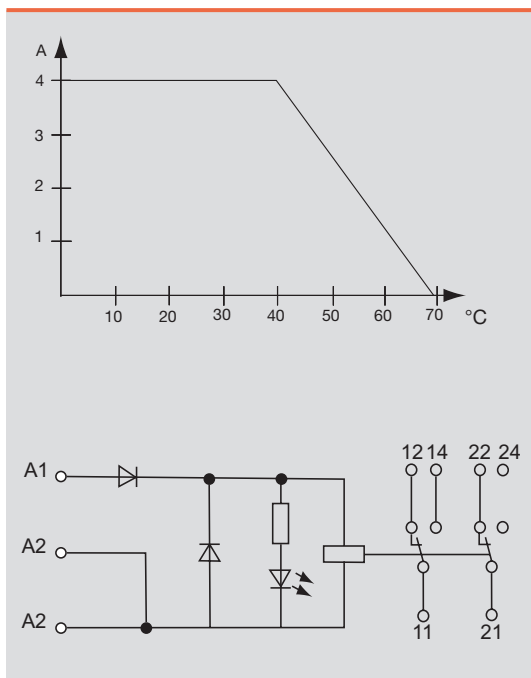
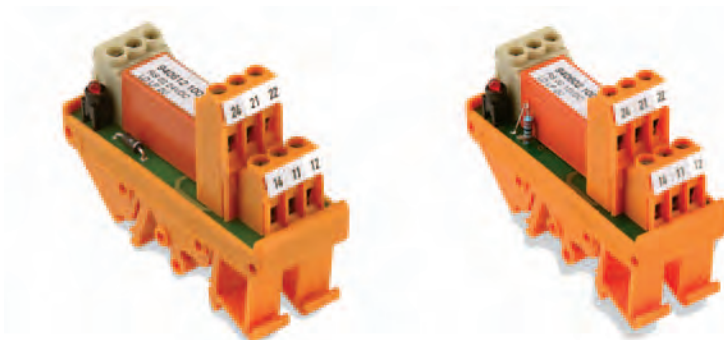

Output		
Max. switching voltage AC/Continuous current	250V/4A	
Min. switching power	10V/100mA	
Response time / Release time	13ms/10ms	
Contact base material	AgNi 0.15 gold flashed	
Mechanical endurance	>30x10 ⁶ switching cycles	
Max. switching frequency at rated load	0.1Hz	
Rated data		
Status indicator/Free wheel diode/Reverse volt. prot.	LED red/No/available	
Ambient temp., fitted w. distance	-25 °C...+40 °C	
Storage temperature	-40 °C...+60 °C	
Climate	40°C/93% rel. humidity without condensation	
Approvals	CE	
Insulation coordinates (EN 50 178)		
Standards	EN 50178	
Rated voltage	250V	
Impulse withstand voltage	4 kV	
Creepage and clearance path input - output	3mm	
Overvoltage category	III	
Pollution severity	2	
Secure separation acc. to VDE 0106 Part 101	No	
Dimensions		
Dimensions	Screw connection	Tension clamp connection
Clamping range (rating- / min. / max.)	mm ²	2.5 / 0.5 / 4
Length x width x height	mm	70.0 / 25.0 / 68.0
Information		

Ordering data

Input	12VDC 2CO	24VDC 2CO	48VDC 2CO	60VDC 2CO
Rated voltage	12 Vdc +/- 10 %	24 Vdc +/- 10 %	48 Vdc +/- 10 %	60 Vdc +/- 10 %
Rated current AC				
Rated current DC	50mA	25mA	12mA	10mA
Power rating	0.6W	0.6W	0.6W	0.6W
Oper.-/drop-out volt. AC-coil				
Oper.-/drop-out volt. DC-coil	11V	21.5V	43V	54V
Pull-in curr./release curr. AC-coil				
Pull-in curr./release curr. DC-coil	-/9.5mA	-/5mA	-/2mA	-/1.5mA

K

Ordering data Complete module

Screw connection	Type	12VDC	24VDC	48VDC	60VDC
		RS 32 12VDC LD LP 2U	RS 32 24VDC LD LP 2U	RS 32 48VDC LD LP 2U	RS 32 60VDC LD LP 2U
Order No.		9406021001	9406121001	9406321001	9406521001
Tension clamp connection	Type				
Order No.					

Ordering data Spare relay, pluggable

Screw connection	Type	12VDC	24VDC	48VDC	60VDC
Order No.					

Information

--	--	--	--	--

RS-SERIES - RS 32

2 change over contacts, UC input

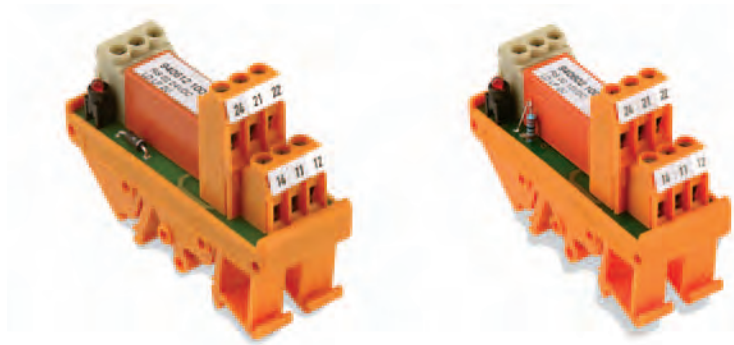

Relay coupler

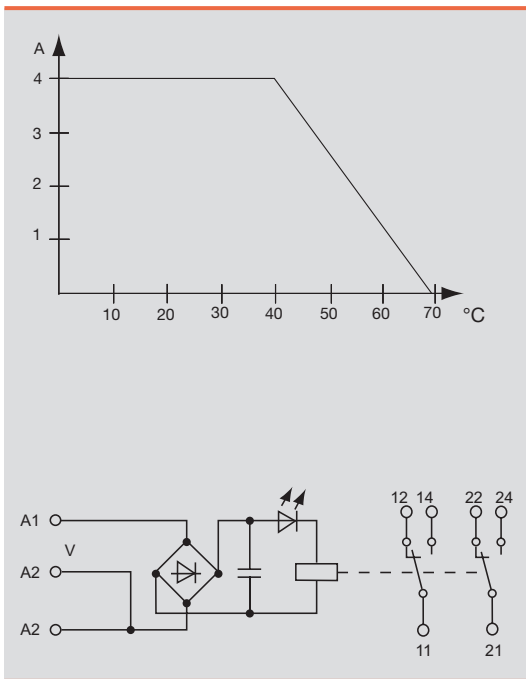

Output	
Max. switching voltage AC/Continuous current	250V/4A
Min. switching power	10V/100mA
Response time / Release time	13ms/10ms
Contact base material	AgNi 0.15 gold flashed
Mechanical endurance	>30x10 ⁶ switching cycles
Max. switching frequency at rated load	0.1Hz
Rated data	
Status indicator/Free wheel diode/Reverse volt. prot.	LED red/No/not available
Ambient temp., fitted w. distance	-25 °C...+40 °C
Storage temperature	-40 °C...+60 °C
Climate	40°C/93% rel. humidity without condensation
Approvals	CE
Insulation coordinates (EN 50 178)	
Standards	EN 50178
Rated voltage	250V
Impulse withstand voltage	4 kV
Creepage and clearance path input - output	3mm
Overtoltage category	III
Pollution severity	2
Secure separation acc. to VDE 0106 Part 101	No

Dimensions	Screw connection	Tension clamp connection
Clamping range (rating- / min. / max.)	mm ² 2.5 / 0.5 / 4	
Length x width x height	mm 70.0 / 25.0 / 68.0	

Information

Ordering data

Input	24VUC 2CO	48VUC 2CO	115VUC 2CO	230VUC 2CO
Rated voltage	24 Vuc +/- 10 %	48 Vuc +/- 10 %	115 Vuc + 5 / - 15%	230 Vuc + 5 / - 15%
Rated current AC	28mAac	18mAac	5mA	4.3mA
Rated current DC	18mAdc	12mAdc	5 mA	4.3mA
Power rating	0.6W // 0.9VA	0.6W // 0.9VA	0.5W // 0.6VA	1W //1VA
Oper.-/drop-out volt. AC-coil				
Oper.-/drop-out volt. DC-coil	21.5V	43V	98V	195V
Pull-in curr./release curr. AC-coil	-/2.5mA	-/4.5mA	-/1.5mA	-/2mA
Pull-in curr./release curr. DC-coil	-/4.5mA	-/2mA	-/1mA	-/1.2mA

Ordering data Complete module

Screw connection	Type	24VUC 2CO	48VUC 2CO	115VUC 2CO	230VUC 2CO
	Type	RS 32 24VUC LD LP 2U	RS 32 48VUC LD LP 2U	RS 32 115VUC LD LP 2U	RS 32 230VUC LD LP 2U
	Order No.	9406221001	9406421001	9406621001	9406721001
Tension clamp connection	Type				
	Order No.				

Ordering data Spare relay, pluggable

Type	24VUC 2CO	48VUC 2CO	115VUC 2CO	230VUC 2CO
Type				
Order No.				

Information

--	--	--	--	--

K

RS-SERIES - RS 32

2 change over contacts, multiple voltage input

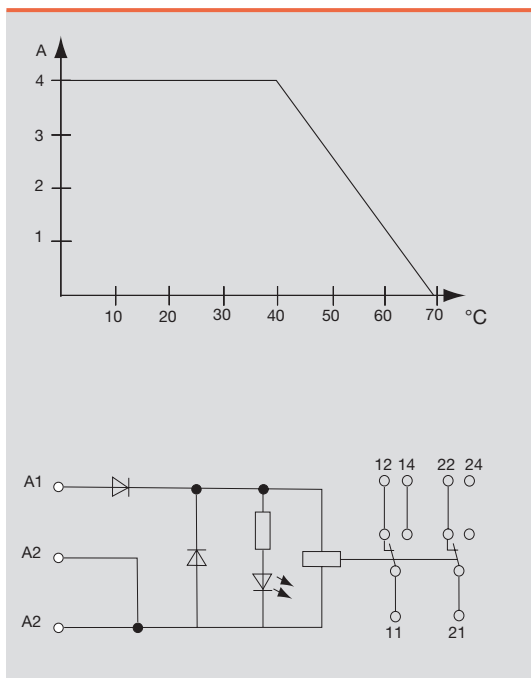
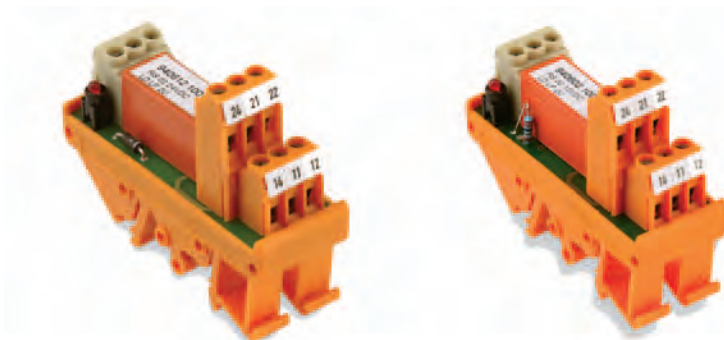

Output	
Max. switching voltage AC/Continuous current	250V/4A
Min. switching power	10V/100mA
Response time / Release time	13ms/10ms
Contact base material	AgNi 0.15 gold flashed
Mechanical endurance	>30x10 ⁶ switching cycles
Max. switching frequency at rated load	0.1Hz
Rated data	
Status indicator/Free wheel diode/Reverse volt. prot.	LED red/No/not available
Ambient temp., fitted w. distance	-25 °C...+40 °C
Storage temperature	-40 °C...+60 °C
Climate	40°C/93% rel. humidity without condensation
Approvals	CE
Insulation coordinates (EN 50 178)	
Standards	EN 50178
Rated voltage	250V
Impulse withstand voltage	4 kV
Creepage and clearance path input - output	3mm
Overvoltage category	III
Pollution severity	2
Secure separation acc. to VDE 0106 Part 101	No
Dimensions	
Clamping range (rating- / min. / max.)	mm ² 2.5 / 0.5 / 4
Length x width x height	mm 70.0 / 25.0 / 68.0
Information	

Ordering data

Input	24-48VUC 2CO	115-230VUC 2CO		
Rated voltage	24 Vuc // 48 Vuc +/- 10 %	115 Vuc // 230 Vuc + 5 / - 15%		
Rated current AC	28mA / 22mA	5.6mA/5.3mA		
Rated current DC	18mA / 20mA	5.4mA/5mA		
Power rating	0.6W // 0.9VA	1W // 1VA		
Oper.-/drop-out volt. AC-coil				
Oper.-/drop-out volt. DC-coil	21.5V/43V	98V/195V		
Pull-in curr./release curr. AC-coil	-/3mA // -/4.5mA	-/1.5mA // -/2mA		
Pull-in curr./release curr. DC-coil	-/5mA // -/2mA	-/1mA // -/1.2mA		

Ordering data Complete module

Screw connection	Type	RS 32 24-48VUC LD LP 2U	RS 32 115-230VUC LD 2U		
Order No.		1122661001	1122761001		
Tension clamp connection	Type				
Order No.					

Ordering data Spare relay, pluggable

Type				
Order No.				

Information

--	--	--	--	--

K

RS-SERIES – with RSM multiple interface

with one change-over contact each

- LEDs red, other colours on request
- Mounting feet can also be mounted turned at an angle of 180°

RSM 4 R / RSM 4 RS

4 relays
soldered or plugged

RSM 8 R / RSM 8 RS

8 relays
soldered or plugged

RSM 16 R / RSM 16 RS

16 relays
soldered or plugged

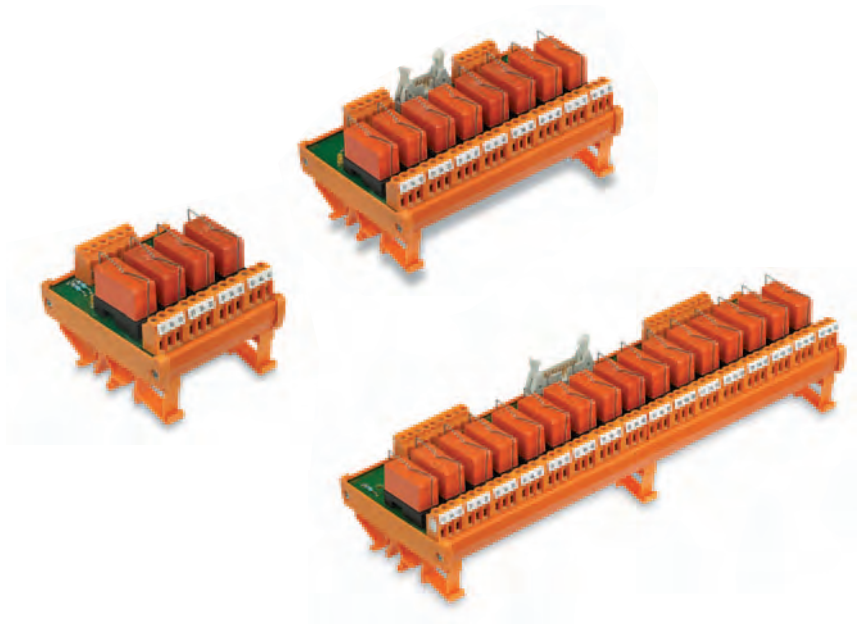

Technical data

Rated data	
Input voltage	
Nominal consumption	soldered relay
	plugged relay
Nominal consumption	soldered relay
	plugged relay
Pull-in current	soldered relay
	plugged relay
Pull-in current	soldered relay
	plugged relay

	24 Vdc	24 Vac/dc	48 Vdc	115 Vac/dc	230 Vac
0.45 W	–	–	–	–	–
0.75 W	0.45 W	0.75 W	–	–	–
–	–	–	–	–	–
–	0.7 VA	–	0.6 VA	1.2 VA	–
12 mA	–	–	–	–	–
23 mA	12 mA	14 mA	5 mA	–	–
–	–	–	–	–	–
–	16.5 mA	–	6 mA	4 mA	–
2 mA	–	1.5 mA	–	1 mA	–
250 V	250 V	250 V	250 V	250 V	250 V
6 A	6 A	6 A	6 A	3 A	–

Release current of relay (at 20°C)
Output voltage max.
Continuous current

Derating curve
a = arranged on mounting rail in horizontal row without spacing
b = arranged on mounting rail in horizontal row with 20 mm spacing

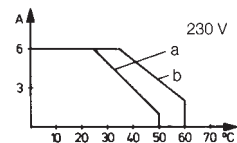
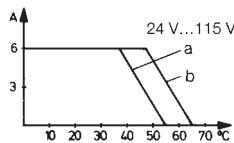

Typical switch-on times

Pick-up delay (ac / dc)	≤ 8 ms	≤ 10 ms / 10 ms	≤ 12 ms	≤ 8 ms / 10 ms	≤ 10 ms
Release delay (ac / dc)	≤ 7 ms	≤ 15 ms / 20 ms	≤ 11 ms	≤ 5 ms / 8 ms	≤ 10 ms

≤ 3 ms	≤ 8 ms	≤ 10 ms	≤ 12 ms	≤ 8 ms / 10 ms	≤ 10 ms
8 A	≤ 7 ms	≤ 15 ms / 20 ms	≤ 11 ms	≤ 5 ms / 8 ms	≤ 10 ms

Duration of bounce	≤ 3 ms
Switch-on current	8 A
Switch-on power under ohmic load	2500 VA
Min. switching power / switching current	250 mW/10 mA
Contact material	AgNi 90/10, AgNi0,15, gold-flashed
Service life	mechanical 24 Vdc, 1A, ohmic load 230 Vac, 3A, ohmic load
Service life	> 30 x 10 ⁶ switching cycles > 5 x 10 ⁵ switching cycles > 7 x 10 ⁵ switching cycles
Storage temperature	–40°C...+60°C
Ambient temperature	–25°C...+50°C

≤ 3 ms	≤ 8 ms	≤ 10 ms	≤ 12 ms	≤ 8 ms / 10 ms	≤ 10 ms
8 A	≤ 7 ms	≤ 15 ms / 20 ms	≤ 11 ms	≤ 5 ms / 8 ms	≤ 10 ms
2500 VA					
250 mW/10 mA					
AgNi 90/10, AgNi0,15, gold-flashed					
> 30 x 10 ⁶ switching cycles > 5 x 10 ⁵ switching cycles > 7 x 10 ⁵ switching cycles					
–40°C...+60°C					
–25°C...+50°C					

Insulation coordination acc. to EN 50 178

Overvoltage category	III
Pollution severity	2

Dimensions

Conductor cross-sectional area (screw connection)	0.5...2.5 mm ²
---	---------------------------

III	
2	

0.5...2.5 mm ²	
---------------------------	--

RS-SERIES – with RSM multiple interface

DC/AC/AC voltage

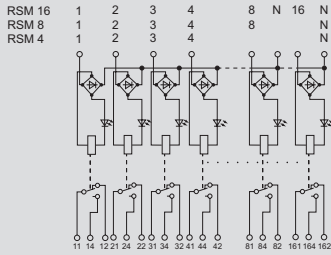

DC voltage, switching minus (negative-switching)

joint plus potential,
minus connected up

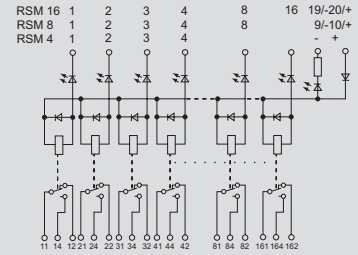

DC voltage, positive-switching

joint minus potential,
plus connected up

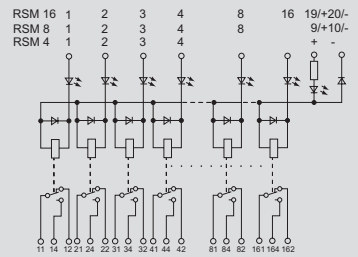

Order data

Connection technology	
Input	Flat band connection Multiple plug with locking acc. to DIN 41651/part 1 and 2
Output	Screw connection
Input	Screw connection <ul style="list-style-type: none"> Plugged relay Screw connection and multiple plug acc. to IEC 603-1/DIN 41651 Relay soldered
Output	Screw connection Multiple plug acc. to IEC 603-1/DIN 41651

Input voltage		4 relays	8 relays	16 relays
		RSM 4 R/RS (B = 75 mm)	RSM 8 R/RS (B = 145 mm)	RSM 16 R/RS (B = 285 mm)
24 Vdc, switching minus	Relay soldered		1100061001	1100161001
	Relay pluggable	1113361001¹⁾	1113561001¹⁾	1113761001¹⁾
24 Vdc, switching plus	Relay soldered	1112361001	1107761001	1107861001
	Relay pluggable	1113461001¹⁾	1113661001¹⁾	1113861001¹⁾
24 Vdc, switching minus	Relay soldered		1112661001	
	Relay pluggable	1173461001	1173561001	1173661001
24 Vac/dc	Relay pluggable	1113961001	1114161001	1114361001
48 Vdc, switching plus	Relay pluggable	1114561001	1114661001	1114761001
115 Vac/dc	Relay pluggable	1114861001	1114961001	1115061001
230 Vac	Relay pluggable			

¹⁾ approved by Germanisch Lloyd

Spare relays (for plugging)

For RSM ... R/RS, 24 V
For RSM ... R/RS, 48 V
For RSM ... R/RS, 115 V and 230 V

Input voltage	Contact material	Remarks	Order no.
24 Vdc	AgNi 90/10	RT 314024 with clip	8630780000
	AgNi 90/10	RT 314024 without clip	4058480000
48 Vdc	AgNi 90/10	RT 314048 with clip	8630790000
	AgNi 90/10	RT 314048 without clip	4058740000
115 Vdc	AgNi 90/10	RT 314110 with clip	8630770000
	AgNi 90/10	RT 314110 without clip	4058500000

MCZ-Series

MiniConditioner MCZ R

Module can be used as an universal interface between control and actuator for switching small and medium loads

- The pluggable cross-connection in input and output minimizes the effort to wire
- Width 6 mm, low height

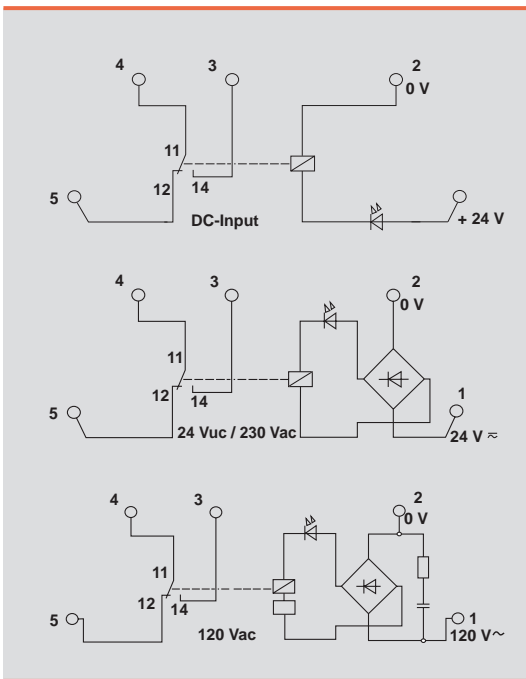

Output	
Max. switching voltage AC/Continuous current	400V/6A
Min. switching power	12V/100mA
Response time / Release time	4.5ms/10ms
Contact base material	AgSnO2
Mechanical endurance	20x10^6 switching cycles
Max. switching frequency at rated load	0.1Hz
Rated data	
Status indicator/Free wheel diode/Reverse volt. prot.	LED green/Yes/available
Ambient temp., fitted w. distance	-25 °C...+50 °C
Storage temperature	-40 °C...+60 °C
Climate	40°C/93% rel. humidity without condensation
Approvals	CE, UL, CSA, GL
Insulation coordinates (EN 50 178)	
Standards	EN 50178
Rated voltage	300 V
Impulse withstand voltage	6 kV
Creepage and clearance path input - output	=> 5.5mm
Overvoltage category	III
Pollution severity	2
Secure separation acc. to VDE 0106 Part 101	Yes

Dimensions	Screw connection	Tension clamp connection
Clamping range (rating- / min. / max.)	mm ²	1.5 / 0.5 / 2.5
Length x width x height	mm	91.0 / 6.0 / 63.2

Information

Applications

Limit diagram

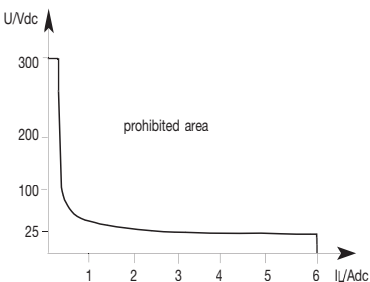

Derating curve

— rowed without clearances on the mounting rail
 - - - - rowed with 20 mm spacing on the mounting rail

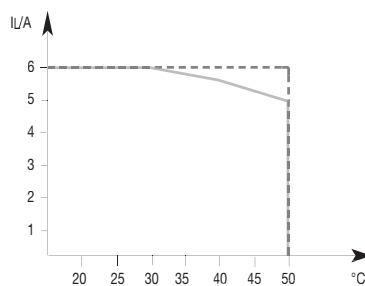

K

MCZ-Series

MiniConditioner MCZ R

Ordering data	24VDC 1CO	24VUC 1CO	24VDC 1CO AU	60VDC 1CO
Input				
Rated voltage	24 Vdc +/- 20 %	24 Vuc +/- 10 %	24 Vdc +/- 20 %	60 Vdc +/- 20 %
Rated current AC		10.8mA		
Rated current DC	6.3mA	6.1mA	6.3mA	3mA
Power rating	156mW	160mVA / 150mW	156mW	180mW
Oper.-/drop-out volt. AC-coil		approx.17V/approx.7V		
Oper.-/drop-out volt. DC-coil	12V...19V/4V...5.5V	approx.19V/approx.4V	12V...19V/4V...5.5V	approx.38V/approx.14V
Pull-in curr./release curr. AC-coil				
Pull-in curr./release curr. DC-coil	5.7mA	9mA/5mA	5.7mA	2.7mA
Ordering data Complete module				
Screw connection Type				
Order No.				
Tension clamp connection Type	MCZ R 24VDC	MCZ R 24VUC	MCZ R 24VDC	MCZ R 60VDC
Order No.	8365980000	8390590000	8442960000	8470380000
Ordering data Spare relay, pluggable				
Type				
Order No.				
Information				
Ordering data				
Input				
Rated voltage	110 Vdc +/- 10 %	120 Vac -15 %/ +10 %	230 Vac +/- 10 %	
Rated current AC		7mA	9.5mA	
Rated current DC	2.85mA			
Power rating	340mW	0.85VA	2.1VA	
Oper.-/drop-out volt. AC-coil		approx.7V/approx.22V	approx.115V/approx.60V	
Oper.-/drop-out volt. DC-coil	approx.68V/approx.19V			
Pull-in curr./release curr. AC-coil		4mA/1.3mA	5mA/2.5mA	
Pull-in curr./release curr. DC-coil	1.6mA/0.4mA			
Ordering data Complete module				
Screw connection Type				
Order No.				
Tension clamp connection Type	MCZ R 110VDC	MCZ R 120VAC	MCZ R 230VAC	
Order No.	8467470000	8420880000	8237710000	
Ordering data Spare relay, pluggable				
Type				
Order No.				
Information				



DK-SERIES

1 NO contact, input bottom

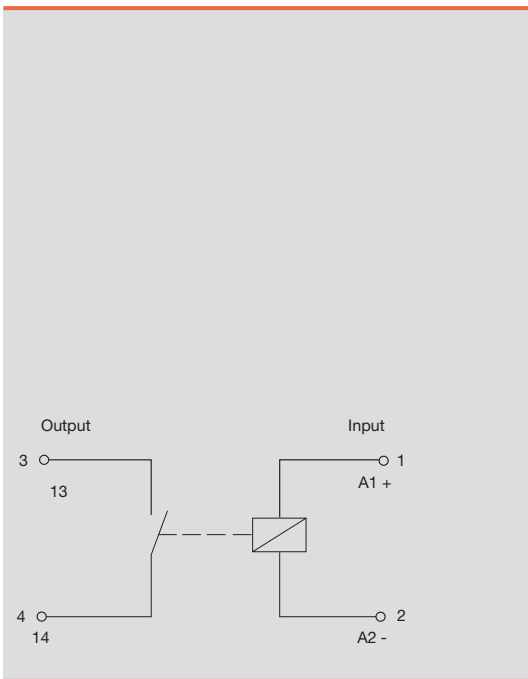
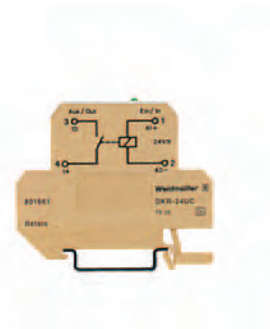

Output	
Max. switching voltage AC/Continuous current	100V/500mA
Min. switching power	1 V / 1 mA
Response time / Release time	typ.0.7...2.5ms/0.2...2ms
Contact base material	RH/RU
Mechanical endurance	10 ⁹ switching cycles
Max. switching frequency at rated load	200Hz
Rated data	
Status indicator/Free wheel diode/Reverse volt. prot.	LED green/Yes/available
Ambient temp., fitted w. distance	-25 °C...+40 °C
Storage temperature	-40 °C...+60 °C
Climate	40°C/93% rel. humidity without condensation
Approvals	CE
Insulation coordinates (EN 50 178)	
Standards	EN 50178
Rated voltage	150 V
Impulse withstand voltage	1.5 kV
Creepage and clearance path input - output	=>3mm
Overvoltage category	III
Pollution severity	2
Secure separation acc. to VDE 0106 Part 101	No
Dimensions	
Clamping range (rating- / min. / max.)	mm ² 4 / 0.5 / 4
Length x width x height	mm 77.0 / 6.0 / 62.0
Information	
	AP DK4: 0687560000

K

Ordering data	5 VDC 1A	12VDC 1A	24VUC 1A	24VDC 1A
Input				
Rated voltage	5 Vdc +/- 5 %	12 Vdc +/- 10 %	12 Vuc +/- 10 %	24 Vdc +/- 20 %
Rated current AC			15mA	
Rated current DC	12.5mA	12mA	12mA	9.3mA
Power rating	65mW	144mW	144mW	225mW
Oper.-/drop-out volt. AC-coil			12V	
Oper.-/drop-out volt. DC-coil	4.4V	9V	11V	11V
Pull-in curr./release curr. AC-coil			6.3mA	
Pull-in curr./release curr. DC-coil	11.8mA	10mA	3.8mA	7.5mA
Ordering data				
For TS 32	Type DKR 32 5VDC 1A		Type DKR 32 24VUC 1A	Type DKR 32 24VDC 1A
	Order No. 8019600000		Order No. 8008110000	Order No. 8016620000
For TS 35	Type DKR 35 5VDC 1A	Type DKR 35 12VDC 1A	Type DKR 35 24VUC 1A	Type DKR 35 24VDC 1A
	Order No. 8019610000	Order No. 8171100000	Order No. 8016610000	Order No. 8008170000
Ordering data				
	Type			
	Order No.			
Information				

DK-SERIES

1 NO contact, input top

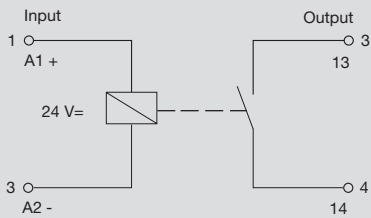
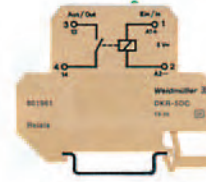

Output	
Max. switching voltage AC/Continuous current	100V/500
Min. switching power	1 V / 1 mA
Response time / Release time	typ.0.7...2.5ms/0.2...2ms
Contact base material	RH/RU
Mechanical endurance	10 ⁴ 9 switching cycles
Max. switching frequency at rated load	25Hz
Rated data	
Status indicator/Free wheel diode/Reverse volt. prot.	LED green/Yes/available
Ambient temp., fitted w. distance	-25 °C...+40 °C
Storage temperature	-40 °C...+60 °C
Climate	40°C/93% rel. humidity without condensation
Approvals	CE
Insulation coordinates (EN 50 178)	
Standards	EN 50178
Rated voltage	150 V
Impulse withstand voltage	1.5 kV
Creepage and clearance path input - output	=>3mm
Overvoltage category	III
Pollution severity	2
Secure separation acc. to VDE 0106 Part 101	No

Dimensions	Screw connection	Tension clamp connection
Clamping range (rating- / min. / max.)	mm ² 4 / 0.5 / 4	
Length x width x height	mm 77.0 / 6.0 / 62.0	
Information	AP DK4: 0687560000	

Ordering data

Input	24 VDC 1A			
Rated voltage	24 Vdc +/- 20 %			
Rated current AC				
Rated current DC	9.3mA			
Power rating	225mW			
Oper.-/drop-out volt. AC-coil				
Oper.-/drop-out volt. DC-coil	11V			
Pull-in curr./release curr. AC-coil				
Pull-in curr./release curr. DC-coil	3.75mA			

Ordering data				
For TS 32	Type			
	Order No.			
For TS 35	Type	DKR 35 24VDC 1A		
	Order No.	8215620000		

Ordering data				
	Type			
	Order No.			

Information				

DK-SERIES

1 change-over contact, input bottom

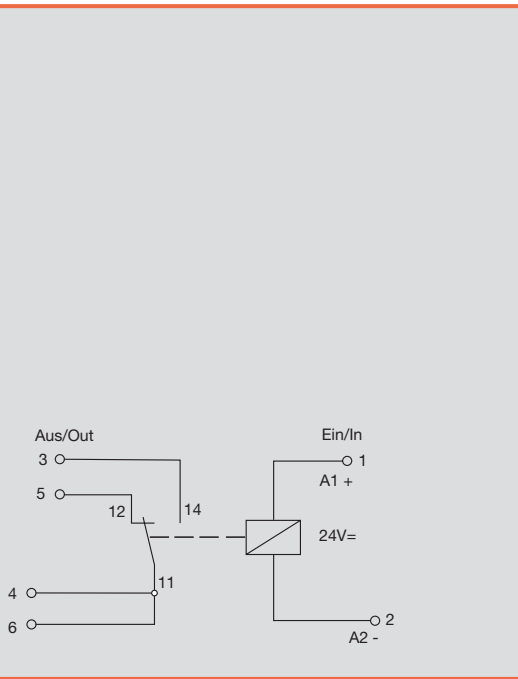
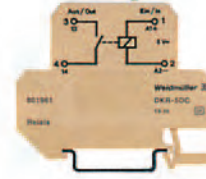

Output	
Max. switching voltage AC/Continuous current	250V/6A
Min. switching power	10 V / 100 mA
Response time / Release time	6ms/15ms ac;8ms dc
Contact base material	AgSnO2
Mechanical endurance	2x10^7 switching cycles
Max. switching frequency at rated load	20
Rated data	
Status indicator/Free wheel diode/Reverse volt. prot.	LED green/Yes/not available
Ambient temp., fitted w. distance	-40°C...+60°C
Storage temperature	-40 °C...+60 °C
Climate	40°C/93% rel. humidity without condensation
Approvals	
Insulation coordinates (EN 50 178)	
Standards	EN 50178
Rated voltage	300 V
Impulse withstand voltage	4 kV
Creepage and clearance path input - output	=>8mm
Overtoltage category	III
Pollution severity	2
Secure separation acc. to VDE 0106 Part 101	No
Dimensions	
Clamping range (rating- / min. / max.)	mm²
Length x width x height	mm
Screw connection	
Clamping range (rating- / min. / max.)	4 / 0.5 / 4
Length x width x height	77.0 / 6.0 / 62.0
Tension clamp connection	
Information	End plate

K

Ordering data		24VUC 1CO	24VDC 1CO	24VUC 1CO	
Input					
Rated voltage		24 Vuc +/- 20 %	24 Vdc +/- 20 %	24 Vuc +/- 20 %	
Rated current AC		9mA		20mA	
Rated current DC		7mA	11.5mA	16mA	
Power rating		220mVA/180mW	384mW	480mW /400mW	
Oper.-/drop-out volt. AC-coil		18V		18V	
Oper.-/drop-out volt. DC-coil		19V	19V	18V	
Pull-in curr./release curr. AC-coil		7mA		12.8mA	
Pull-in curr./release curr. DC-coil		5.5mA	9mA	11.5mA	
Ordering data					
For TS 32	Type	DKR DK5 24VUC 1U			
	Order No.	9454910000			
For TS 35	Type	DKR DK5 24VUC 1U	DKR 35 24VDC 1U	DKR 35 24VUC 1U	
	Order No.	9454910000	8181980000	8181970000	
Ordering data					
	Type				
	Order No.				
Information					

EG SERIES

1 NCC, 1 NOC, 1 change-over contact

- Also with hard gold-plated contacts
- With combination foot for TS 32, TS 32 and TS 35 (clip-in base for plug-in) change-over contacts
- 10 mm wide
- Screw connection

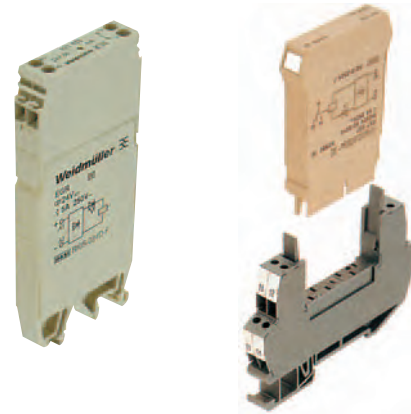

Main-line wiring diagram

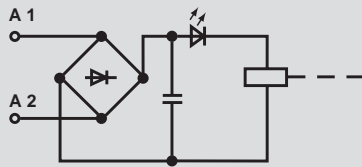

Main-line wiring diagram

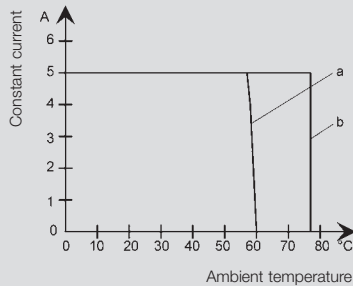

a = arranged on mounting rail in horizontal row without spacing

b = arranged on mounting rail in horizontal row with 20 mm spacing

Technical data

Output	
Max. switching voltage AC / constant current	250 V / 5 A
Min. switching power	100 mW / 10 mA
hard gold-plated contacts	40 µW
Response time/release time	≤ 8 ms / ≤ 6 ms
Contact base material	AgNi 0.15 gold-flashed
hard gold-plated contacts	AgNi 0.15 / 5 µ Au
Mechanical service life	> 15 x 10 ⁶ switching cycles
Max. switching frequency at rated load	0,1 Hz
Nominal data	
Status indicator/recovery diode	LED green / yes
Ambient temperature arranged in horizontal row with spacing	-25 °C ... +60 °C
Lagertemperatur	-40 °C ... +60 °C
Insulation coordination (EN 50 178)	
Standards	EN 50178
Rated voltage	300 V
Rated impuls voltage	8 kV
Creepage and clearance path input-output	≥ 8 mm
Overvoltage category	III
Pollution severity	2
Protective separation acc. to VDE 0106 part 101	DIN VDE 0106

		1 NOC, 1 NCC	1 change-over contact
Clamping range (nom./min/max)	mm ²	1.5 x 0.5 x 1.5	1.5 x 0.5 x 1.5
Length x width x height	mm	44.0 x 10.0 x 96.0	95.0 x 10.0 x 93.0
Remarks			

EG SERIES

1 NOC, 1 NCC, 1 change-over contact

Order data	12 Vac/dc	24 Vdc	24 Vac/dc	115Vac/dc
Input				
Rated voltage	12 Vac/dc, +15%, -10 %	24 Vdc +15 % -10 %	24 Vac/dc +15 % -10 %	115 Vac/dc + 15 % -10 %
Nominal power	320 mW +20% -10%	280 mW +20% -10%	280 mW +20% -10%	330 mW +15% -10%
Switch-on current, max.	120 mA	12 mA	240 mA	160 mA
Order data with combination foot				
1 NOC Type	EGR EG 7	EGR EG 7	EGR EG7	EGR EG7
Order no.	8092310000	8216520000	8092340000	8092430000
1 NCC Type	EGR EG 7	EGR EG 7	EGR EG7	EGR EG7
Order no.	8092320000	8216530000	8092350000	8092440000
Order data, pluggable (order clip-in base separately)				
1 change-over contact Type	RST EG 7	RST EG 7	RST EG 7	RST EG 7
Order no.	8216550000	8216570000	8216580000	8216610000
1 clip-in base Type	RS EG 7	RS EG 7	RS EG 7	RS EG 7
Order no.	8193830000	8193830000	8193830000	8193830000

Order data	230 Vac	Contacts hard gold-plated	24 Vdc	230 Vac
Input				
Rated voltage	230 Vac +15 % -10 %		24 Vdc +15% -10%	230 Vac +15% -10%
Nominal power	280 mW +15% -10%		280 mW +20% -10%	280 mW +15% -10%
Switch-on current, max.	185 mA		12 mA	185 mA
Order data with combination foot				
1 NOC Type	EGR EG 7		EGR EG 7	EGR EG 7
Order no.	8092460000		8147120000	8178200000
1 NCC Type	EGR EG 7		EGR EG 7	
Order no.	8092470000		8147140000	
Order data, pluggable (order clip-in base separately)				
1 change-over contact Type	RST EG 7		RST EG 7	RST EG 7
Order no.	8216620000		8216560000	8216630000
1 clip-in base Type	RS EG 7		RS EG 7	RS EG 7
Order no.	8193830000		8193830000	8193830000

