

BT-SERIES

Installation time relays

Electronic time relays in the BT product family offer ideal solutions for industrial use.

The BT product family provides the following functions:

- Pick-up delay (BTR)
- Pulse emitter (BTTT)
- Multi-function (BTM)
- Multi-function (BTMF)
- Star delta change-over

Time ranges and power supply for the time relays

Using the central knob, the functions of the modules are selected precisely over either 4 or 8 time ranges.

The multi-voltage supply voltage range offers a wide bandwidth for industrial use (see table).

Time ranges

Display of time scale	Time range
0.1 s	0.1 to 1.2 s
1 s	1 to 12 s
0.1 min	0.1 to 1.2 min
1 min	1 to 12 min
0.1 h	0.1 to 1.2 h
1 h	1 to 12 h
10.h	10 to 120 h

Note: If the rotary knob for time adjustment is set on "0", the output will be switched without delay.

Output of the time relays

In every module, a change-over contact (250 V, 8A) switches the load. The multi-function module (BTM) activates both change-over contacts immediately, or one change-over contact immediately and the second after a delay.

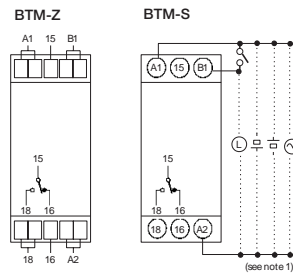

(DIN notation)

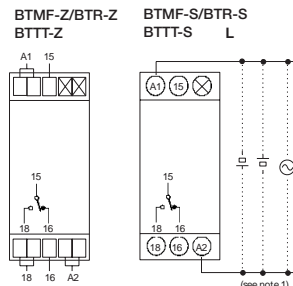

(DIN notation)



- Note:
1. Pole numbers are not necessary for DC voltage supply.
 2. The contact symbol of H3DS is marked with , as it provides several operating modes and differs from the delayed contacts of conventional time relays.

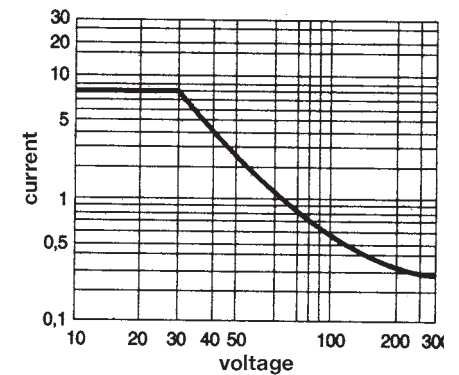
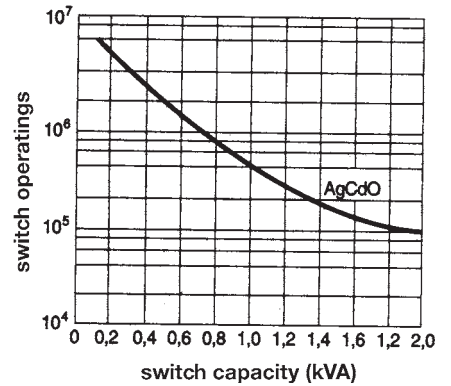

BT-SERIES

Choosing the time range

The time range is chosen by turning the rotary switch for the ON-time scale and OFF-time scale. The time scales are visible in the display left of the rotary switch in the following order: 0,1 s, 1 h, 0,1 h, 1 m, 1 s, 0,1 h, 0,1 m, 1 s.

Note: The time scales "1 s" and "0,1 h" are named twice. Both adjustments represent the same time scale.

Locking/unlocking of selectors and time setting dial

The rotary switches for the ON/OFF time adjustment and the option selector for the time scale can be locked with the locking key.

This pen-styled special tool is separately available. To lock either rotary switches or the option selector the locking key just needs to be put into the key hole on the lower right of the rotary switch/option selector is totally covered by the red cover. To unlock simply turn the key in the opposite direction.

Connection technology

The tension clamp offers the following connection capacities:

Screw connection

- 2 x 1.5 mm² with wire end ferrule
- 2 x 2.5 mm² without wire end ferrule

Tension clamp connection

- 2 x 1.5 mm² with wire end ferrule
- 2 x 2.5 mm² without wire end ferrule

Dimensions

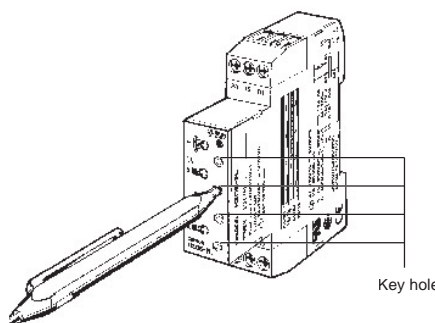
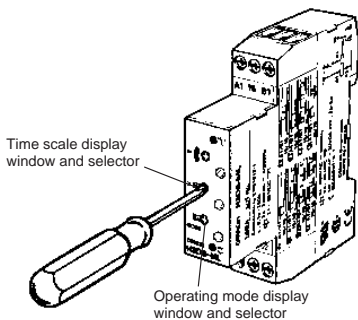
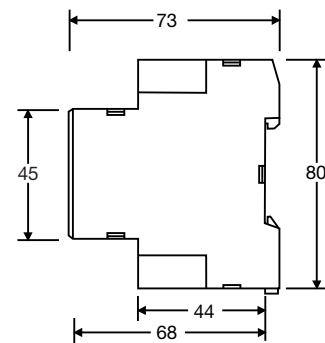

Screw connection

Tension clamp connection

BTM-S/BTMF-S

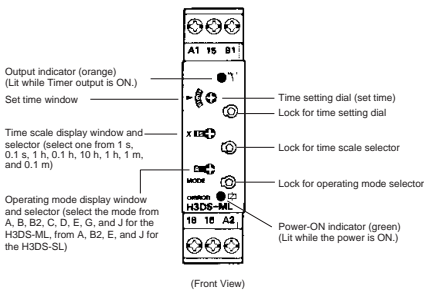

BTR-S

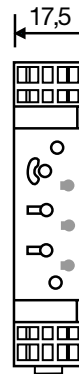
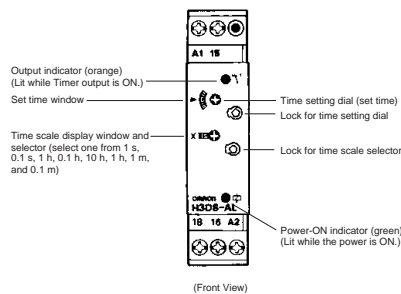

BTTT-S

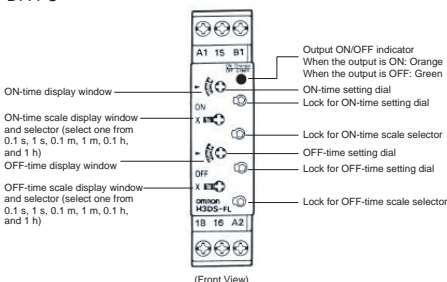

BTDSS

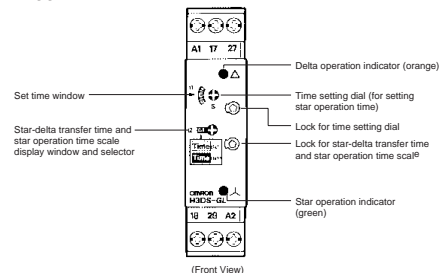

BT-SERIES

Installation time relays

- Screw or tension clamp connection
- LED status indicator Input: voltage present
Output: output active
- Approvals

508 EN 61812-1 IEC 60947-5-1 IEC 60664-1 EN 55011	22.2 Nr. 14 IEC 60664-1 EN 61812-1 IEC 60947-5-1 EN 50082-2
---	---



Type designation:

- B** = Building
- T** = Timer
- R** = Response Delay
- TT** = Two Times
- M** = Multifunction, 8 ranges
- MF** = Multifunction, 4 ranges
- DS** = Delta, Star
- S** = Screw
- Z** = Tension

Input		Contacts hard gold plated
Rated voltage		24 ... 230 Vac, 50/60 Hz, 24 ... 48 Vdc
Voltage tolerance		85 ... 100° of rated voltage
Switch-off voltage		Max. 2.4 Vac/Vdc
Power consumption by type	Vac	21...33 VA at 230 V
	Vdc	0.6...1.3 W at 24 V
Reset time		Min. 0.1 s (BTDS: 0.5 s)
Insulation		
Insulation resistance		100 MΩ min., at 500 Vdc
Insulation test voltage		
	between input and output to enclosure	2000 Vac, 50/60 Hz, 1 min
	between non-adjacent contacts	1000 Vac, 50/60 Hz, 1 min
Protection class		IP30, terminal block IP20
Output		
Contact/contact material		1 change-over switch (BTDS 2 NOC) / AgNi 90/10
Switch output		5A at 250 Vac, resistive load (cos φ = 1)
Service life	mechanical min.	10 ⁷ switching cycles (no load, 1'800/h)
	electrical min.	10 ⁵ switching cycles (5A at 250 Vac, resistive load at 1'800/h)
Time range		0.10 s ... 120 h
Repetition accuracy		± 1 %
Other data		
Flammability class as per UL 94		V-2
Ambient temperature/storage temperature		-10...+55°C / -25 ... +65°C (without condensation)
Clamping range (nominal/min/max)	mm ²	
Length x width x height	mm	80.0 x 17.5 x 73.0

Accessories

Locking and adjusting key

BT Lock Pen

1 865840000

BT-SERIES

Multi-function relay with control input (BTM)

Order data

Connection technology	Type	Qty	Order no.
Screw connection	BTM-S	1	8647700000
Tension clamp	BTM-Z	1	8647710000

Functions

Function A – pick-up delay

The set time T begins to be subject to delay when the input signal (A1/B1) is applied. The output R (15/18) connects the load at the end of the set time.



Function G – pick-up and release delayed

After applying the input signal (A1/B1), time delay T begins. At the end of this time, output R (15/18) connects the load (pick-up delayed). After the input signal (A1/B1) has been switched off again, the output switches the load off again after the set time (release delayed).

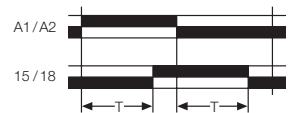

Function B – pulse emitter (starts at idle setting)

After applying the input signal (A1/B1), output R (15/18) synchronously switches the load alternately between the idle and work settings within the set time T . With this function, the cycle starts at the idle setting.



Function J – pick-up delay with pulse

After applying the input signal (A1/B1), the time delay T begins. At the end of this time, the output R (15/18) connects the load for 1 second.

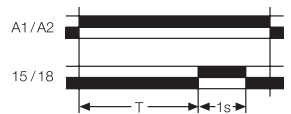

Function B2 – pulse emitter (starts at work setting)

After applying the input signal (A1/B1), output R (15/18) synchronously switches the load alternately between the idle and work settings within the set time T . With this function, the cycle starts at the work setting.



Function C – wipe function

After applying the input signal (A1/B1), output R (15/18) connects the load for the set time T . Output R switches the load off again at the end of time T .



After switching off the input signal (A1/B1), output R (15/18) connects the load again for the set time T . Output R (15/18) switches the load off again at the end of time T .

Function D – release delayed

After applying the input signal (A1/B1), output R (15/18) connects the load. The time delay T begins after the input signal (A1/B1) has been switched off. At the end of time T , output R (15/18) switches the load off again.



Function E – switch on wiping

After applying the input signal (A1/B1), output R (15/18) connects the load immediately. At the end of the set delay time T , output R (15/18) switches the load off again.



BT-SERIES

Multi-function relay without control input (BTMF)

Time relay (BTR)

Functions

Connection technology	Type	Qty	Order no.
Screw connection	BTMF-S	1	8647680000
Tension clamp	BTMF-Z	1	8647690000

Functions

Connection technology	Type	Qty	Order no.
Screw connection	BTR-S	1	8647720000
Tension clamp	BTR-Z	1	8647730000

Order data

Function A – pick-up delay

The set time T begins to be subject to delay when the power supply is applied. At the end of the set time, the output connects the load.

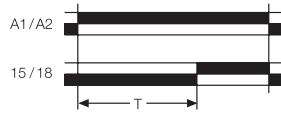

Order data

Function A – pick-up delay

The set time T begins to be subject to delay when the power supply is applied. At the end of the set time, the output R connects the load.

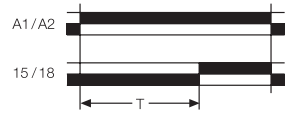

Function B2 – pulse emitter (begins with work setting)

After applying the supply voltage, output R synchronously switches the load alternately between the idle and work settings within the set time T. With this function, the cycle starts at the work setting.



Function E – switch on wiping

After applying the supply voltage, output R connects the load immediately. After the set delay time T, output R (15/18) switches the load off again.

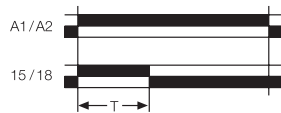

Function J – pick-up delay with pulse

After applying the power supply, the time delay T begins. At the end of this time, the output R (15/18) connects the load for 1 second.



BT-SERIES

Time relay (BTTT)

Functions

Connection technology	Type	Qty	Order no.
Screw connection	BTTT-S	1	8647740000
Tension clamp	BTTT-Z	1	8647750000

Order data

Function BTTT - pulse emitter

After applying the supply voltage, the repeat cycle begins with two independently adjusted times.

The standard setting is to begin with the idle setting.

A bridge between connections A1 and B1 allows the module to begin at the work setting.



Time relay (BTDS)

Functions

Connection technology	Type	Qty	Order no.
Screw connection	BTDS-S	1	8647660000
Tension clamp	BTDS-Z	1	8647670000

Order data

Star-delta change-over

After applying the supply voltage, output R1 (17/18) connects immediately. At the end of time T1, output R1 (17/18) switches off and time T2 starts.

At the end of time T2, output R2 (27/28) connects.

After switching off the supply voltage, output R2 (27/28) switches off.

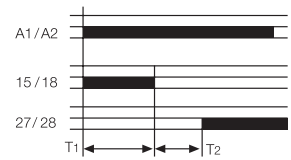

DK-SERIES

Minicoupler DKZ

- Components to lengthen short pulses for the PLC
- Provides versions with fixed switch on/switch off delay
- Low input power
- Screw connection technology
- 6 mm width
- Mounting on TS35

24VDC 50MS

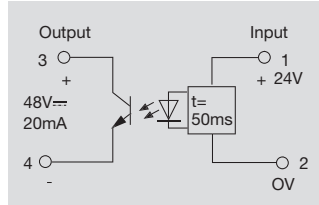
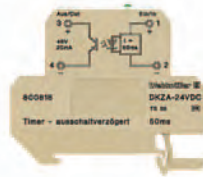

24VDC 150MS

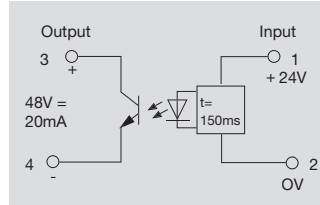
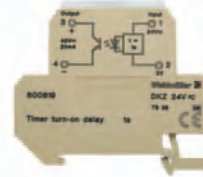

24VUC 1S

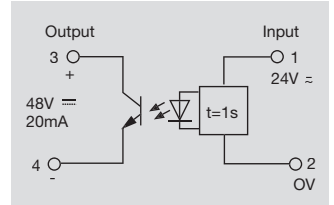
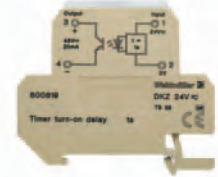

Technical data

Input

- Rated voltage
- Rated current DC
- Rated current AC
- Power rating
- Switch-on delay
- Switch-off delay
- Min. impulse duration

24 Vdc +/- 18 %
6.7mA
160mW
50ms
2.0

24 Vdc +/- 18 %
6.7 mA
160mW
150ms
2.5

24 Vuc +/- 10 %
5.1 mA
6.1 mA
130mW / 150mVA
1s
max.0.7ms

Output

- Max. switching voltage DC
- Switching current max.
- Max. switching frequency at rated load

48V
20.0mA
20Hz

48V
20.0mA
20Hz

48V
20.0mA
0.90Hz

Rated data

- Ambient temp., fitted w/o distance
- Storage temperature

-25 °C...+50 °C
-40 °C...+85 °C

-25 °C...+50 °C
-40 °C...+85 °C

-25 °C...+50 °C
-40 °C...+85 °C

Insulation coordinates (EN 50 178)

- Rated voltage
- Impulse withstand voltage
- Overvoltage category
- Pollution severity
- Creepage and clearance path input - output
- Voltage strength, Input/Output

300 V
4 kV
III
≥4mm
4 kV

300 V
4 kV
III
2
≥4mm
4 kV

300 V
4 kV
III
2
≥4mm
4 kVeff

Dimensions

- Clamping range (rating- / min. / max.) mm²
- Length x width x height mm

Screw connection

4 / 0.50 / 4
65.0 x 6.0 x 62.0

Screw connection

4 / 0.50 / 4
65.0 x 6.0 x 62.0

Screw connection

4 / 0.50 / 4
65.0 x 6.0 x 62.0

Information

Assembly on mounting rail TS 35

Assembly on mounting rail TS 35

Assembly on mounting rail TS 35

Ordering data

Connection technology

Screw connection

Type	(Qty.=10)	Order No.
DKZA 35 24VDC 50MS		8008180000

Type	(Qty.=10)	Order No.
DKZA 35 24VDC 150MS		8022110000

Type	(Qty.=10)	Order No.
DKZ 35 24VUC 1S		8008190000

Information

Accessories

Information

End plate
AP DK4 0687560000

End plate
AP DK4 0687560000

End plate
AP DK4 0687560000

DK-SERIES

Minicoupler DKZ

- Components to lengthen short pulses for the PLC
- Provides versions with fixed switch on/switch off delay
- Low input power
- Screw connection technology
- 6 mm width
- Mounting on TS35

24VDC 10-100MS

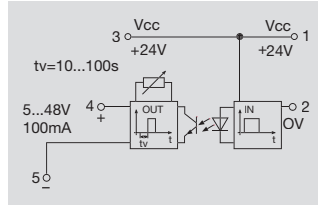
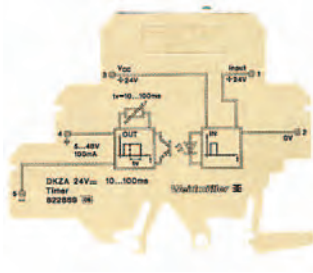

24VDC 0.1-1S

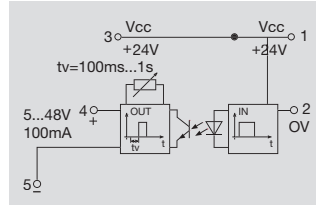

24VDC 1-100S

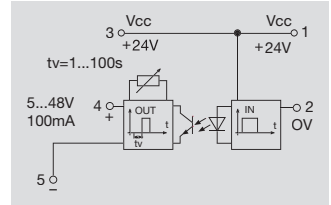

Technical data

Input

Rated voltage	24 Vdc +/- 20 %
Rated current DC	approx. 12mA
Power rating	290mW
Switch-on delay	10...100ms (adjustable)

Output

Max. switching voltage DC	48V
Switching current max.	100.0mA

Rated data

Ambient temp., fitted w/o distance	-25 °C...+50 °C
Storage temperature	-40 °C...+85 °C

Insulation coordinates (EN 50 178)

Rated voltage	300 V
Impulse withstand voltage	6 kV
Overvoltage category	IV
Pollution severity	2
Creepage and clearance path input - output	>=5.5mm
Voltage strength, Input/Output	4 kV

Rated voltage	24 Vdc +/- 20 %
Rated current DC	approx. 12mA
Power rating	290mW
Switch-on delay	100ms...1s (adjustable)

Max. switching voltage DC	48V
Switching current max.	100.0mA

Ambient temp., fitted w/o distance	-25 °C...+50 °C
Storage temperature	-40 °C...+85 °C

Rated voltage	300 V
Impulse withstand voltage	6 kV
Overvoltage category	IV
Pollution severity	2
Creepage and clearance path input - output	>=5.5mm
Voltage strength, Input/Output	4 kV

Rated voltage	24 Vdc +/- 20 %
Rated current DC	approx. 12mA
Power rating	290mW
Switch-on delay	1...100s (adjustable)

Max. switching voltage DC	48V
Switching current max.	100.0mA

Ambient temp., fitted w/o distance	-25 °C...+50 °C
Storage temperature	-40 °C...+85 °C

Rated voltage	300 V
Impulse withstand voltage	6 kV
Overvoltage category	IV
Pollution severity	2
Creepage and clearance path input - output	>=5.5mm
Voltage strength, Input/Output	4 kV

Rated voltage	24 Vdc +/- 20 %
Rated current DC	approx. 12mA
Power rating	290 mW
Switch-on delay	1...100s (adjustable)

Max. switching voltage DC	48V
Switching current max.	100.0mA

Ambient temp., fitted w/o distance	-25 °C...+50 °C
Storage temperature	-40 °C...+85 °C

Rated voltage	300 V
Impulse withstand voltage	6 kV
Overvoltage category	IV
Pollution severity	2
Creepage and clearance path input - output	>=5.5mm
Voltage strength, Input/Output	4 kV

Dimensions

Clamping range (rating- / min. / max.)	mm ²
Length x width x height	mm

Information

Screw connection

4 / 0.50 / 4
77.0 x 6.0 x 62.0

Assembly on mounting rail
TS32/35

Screw connection

4 / 0.50 / 4
77.0 x 6.0 x 62.0

Assembly on mounting rail
TS32/35

Screw connection

4 / 0.50 / 4
77.0 x 6.0 x 62.0

Assembly on mounting rail
TS32/35

Ordering data

Connection technology

Screw connection

Type	(Qty.=10)	Order No.
DKZ DK5 24VDC 10-100MS		8228680000

Type	(Qty.=10)	Order No.
DKZ DK5 24VDC 0.1-1S		8243780000

Type	(Qty.=10)	Order No.
DKZ DK5 24VDC 1-100S		8019650000

Information

Accessories

Information

End plate
AP DK5 8268870000

End plate
AP DK5 8268870000

End plate
AP DK5 8268870000

DK-SERIES

Minicoupler DKZ

- Components to lengthen short pulses for the PLC
- Provides versions with fixed switch on/switch off delay
- Low input power
- Screw connection technology
- 6 mm width
- Mounting on TS35

24VDC 10-100MS

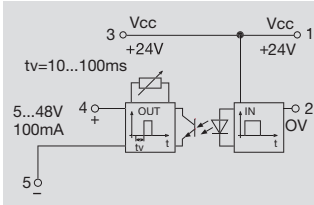
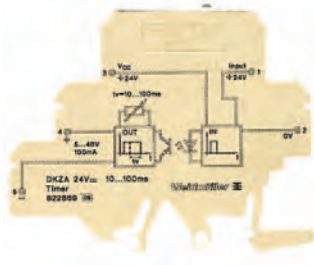

24VDC 0,1-1S

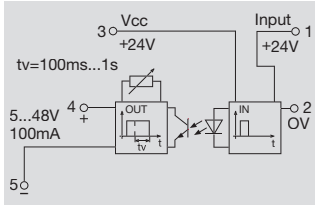
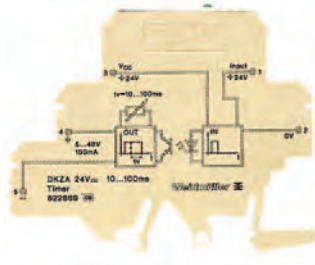

24VDC 1-100S

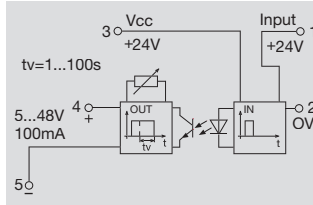

Technical data

Input

- Rated voltage
- Rated current DC
- Power rating
- Switch-off delay

Output

- Max. switching voltage DC
- Switching current max.

Rated data

- Ambient temp., fitted w/o distance
- Storage temperature

Insulation coordinates (EN 50 178)

- Rated voltage
- Impulse withstand voltage
- Overvoltage category
- Pollution severity
- Creepage and clearance path input - output
- Voltage strength, Input/Output

24 Vdc +/- 20 %
approx. 11mA

10...100ms (adjustable)

48V
100.0mA

-25 °C...+50 °C
-40 °C...+85 °C

300 V

6 kV

IV

2

>=5.5mm

24 Vdc +/- 20 %
approx. 11mA

100ms...1s (adjustable)

48V
100.0mA

-25 °C...+50 °C
-40 °C...+85 °C

300 V

6 kV

IV

2

>=5.5mm

4 kV

24 Vdc +/- 20 %
approx. 11mA

1...100s (adjustable)

48V
100.0mA

-25 °C...+50 °C
-40 °C...+85 °C

300 V

6 kV

IV

2

>=5.5mm

4 kV

Dimensions

- Clamping range (rating- / min. / max.) mm²
- Length x width x height mm

Information

Screw connection

- 4 / 0.50 / 4
- 77.0 x 6.0 x 62.0

Assembly on mounting rail
TS32/35

Screw connection

- 4 / 0.50 / 4
- 77.0 x 6.0 x 62.0

Assembly on mounting rail
TS32/35

Screw connection

- 4 / 0.50 / 4
- 77.0 x 6.0 x 62.0

Assembly on mounting rail
TS32/35

Ordering data

Connection technology

Screw connection

Type (Qty.=10) Order No.

DKZA DK5 24VDC 10-100MS **8228690000**

Type (Qty.=10) Order No.

DKZA DK5 24VDC 0.1-1S **8243770000**

Type (Qty.=10) Order No.

DKZA DK5 24VDC 1-100S **8019630000**

Information

Accessories

Information

End plate
AP DK5 8268870000

End plate
AP DK5 8268870000

MCZ-SERIES

Miniconditioner MCZ TO

- Components to lengthen short pulses for the PLC
- Switch-off delay fixed adjusted
- Low input power
- Tension clamp connection technology
- Pluggable cross-connection
- 6 mm width
- Mounting on TS35

24VDC 50MS

24VDC 150MS

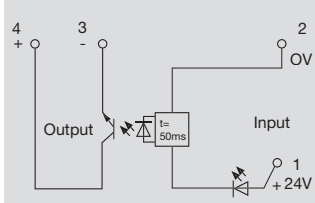
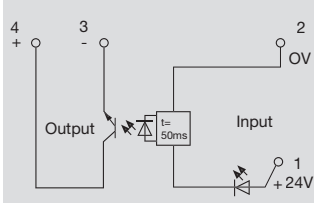
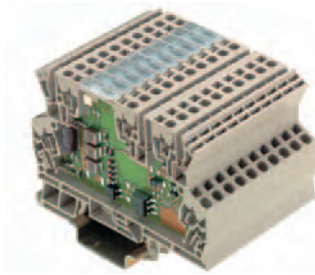
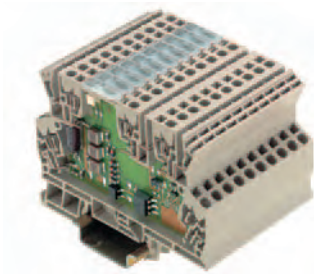

Technical data

Input

Rated voltage	24 Vdc +/- 10 %
Rated current DC	6.7mA +/-10%
Power rating	160mW
Switch-off delay	50ms
Min. impulse duration	2.0ms

Output

Max. switching voltage DC	48V
Switching current max.	20.0mA
Max. switching frequency at rated load	20Hz

Rated data

Ambient temp., fitted w. distance	-25 °C...+50 °C
Storage temperature	-40 °C...+85 °C

Insulation coordinates (EN 50 178)

Rated voltage	300 V
Impulse withstand voltage	6 kV
Overvoltage category	III
Pollution severity	2
Creepage and clearance path input - output	>=5.5mm
Voltage strength, Input/Output	4 kV

Rated voltage	24 Vdc +/- 10 %
Rated current DC	6.7mA +/-10%
Power rating	160mW
Switch-off delay	50ms
Min. impulse duration	2.0ms

Max. switching voltage DC	48V
Switching current max.	20.0mA
Max. switching frequency at rated load	20Hz

Ambient temp., fitted w. distance	-25 °C...+50 °C
Storage temperature	-40 °C...+85 °C

Rated voltage	300 V
Impulse withstand voltage	6 kV
Overvoltage category	III
Pollution severity	2
Creepage and clearance path input - output	>=5.5mm
Voltage strength, Input/Output	4 kV

Rated voltage	24 Vdc +/- 10 %
Rated current DC	6.7mA +/-10%
Power rating	160mW
Switch-off delay	150ms
Min. impulse duration	2.5ms

Max. switching voltage DC	48V
Switching current max.	20.0mA
Max. switching frequency at rated load	20Hz

Ambient temp., fitted w. distance	-25 °C...+50 °C
Storage temperature	-40 °C...+85 °C

Rated voltage	300 V
Impulse withstand voltage	6 kV
Overvoltage category	III
Pollution severity	2
Creepage and clearance path input - output	>=5.5mm
Voltage strength, Input/Output	4 kV

Dimensions

Clamping range (rating- / min. / max.)	mm ²
Length x width x height	mm

Information

Tension clamp c.

1.50 / 0.50 / 2.50
91.0 x 6.0 x 63.2

CE, UL, CSA
Assembly on TS35

Tension clamp c.

1.50 / 0.50 / 2.50
91.0 x 6.0 x 63.2

CE, UL, CSA
Assembly on TS35

Ordering data

Connection technology

Tension clamp c.

Type	(Qty.=10)	Order No.
MCZ TO 24VDC/50MS		8324590000

Type	(Qty.=10)	Order No.
MCZ TO 24VDC/150MS		8286410000

Information

Accessories

Information

Endplate	AP MCZ	8389030000
----------	--------	------------

End plate	AP MCZ	8389030000
-----------	--------	------------