

Installation Guide

Advanced sensor with dual digital displays for use with plastic and glass fiber optic assemblies.

For complete technical information about this product, including dimensions, accessories, and specifications, see Banner Engineering website.

Overview



Figure 1. DF-G1 Model Features

1	Output LED
2	LO/DO Switch
3	RUN/PRG/ADJ Mode Switch
4	Lever Action Fiber Clamp
5	Red Signal Level
6	Green Threshold
7	+ /SET/ - Rocker Button



WARNING: Not To Be Used for Personnel Protection

Never use this device as a sensing device for personnel protection. Doing so could lead to serious injury or death. This device does not include the self-checking redundant circuitry necessary to allow its use in personnel safety applications. A sensor failure or malfunction can cause either an energized or de-energized sensor output condition.

Models

Model	Outputs	Connector ¹
DF-G1-NS-2M	Single NPN	2 m (6.5 ft) cable, 4-wire
DF-G1-PS-2M	Single PNP	
DF-G1-KS-2M	Dual outputs, 1 push-pull IO-Link and 1 PNP (complementary outputs)	
DF-G1-NS-Q5	Single NPN	150 mm (6 in) PVC pigtail, M12 Euro QD connector, 4-pin
DF-G1-PS-Q5	Single PNP	
DF-G1-KS-Q5	Dual outputs, 1 push-pull IO-Link and 1 PNP (complementary outputs)	
DF-G1-NS-Q7	Single NPN	Integral M8 Pico QD connector, 4-pin
DF-G1-PS-Q7	Single PNP	
DF-G1-KS-Q7	Dual outputs, 1 push-pull IO-Link and 1 PNP (complementary outputs)	

¹ Connector options:

- A model with a QD connector requires a mating cordset .
- For 9 m cable, change the suffix 2M to 9M in the 2 m model number (example, DF-G1-NS-9M).
- For 150 mm (6 in) PVC pigtail, M8 Pico QD connector, 4-pin change the suffix 2M to Q3 in the 2 m model number (example, DF-G1-NS-Q3).

Installation Instructions

Mounting Instructions

Mount on a DIN Rail

1. Hook the DIN rail clip on the bottom of the DF-G1 over the edge of the DIN rail (1).
2. Push the DF-G1 up on the DIN rail (1).
3. Pivot the DF-G1 onto the DIN rail, pressing until it snaps into place (2).

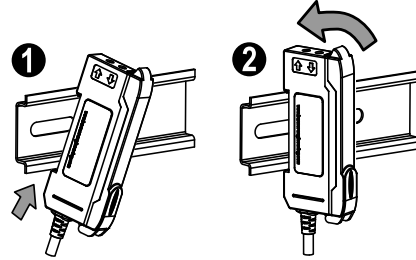

Mount to the Accessory Bracket

1. Position the DF-G1 in the SA-DIN-BRACKET.
2. Insert the supplied M3 screws.
3. Tighten the screws.

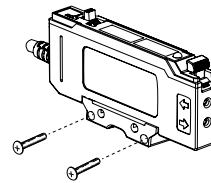

Remove from a DIN rail

1. Push the DF-G1 up on the DIN rail (1).
2. Pivot the DF-G1 away from the DIN rail and remove it (2).

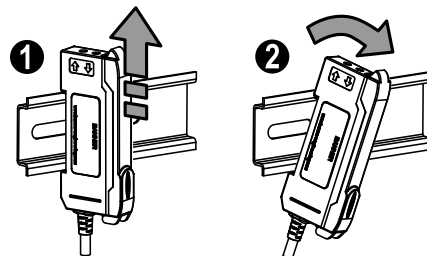

Installing the Fibers

Follow these steps to install glass or plastic fibers.

1. Open the dust cover.
2. Move the fiber clamp forward to unlock it.
3. Insert the fiber(s) into the fiber port(s) until they stop.
4. Move the fiber clamp backward to lock the fiber(s).
5. Close the dust cover.

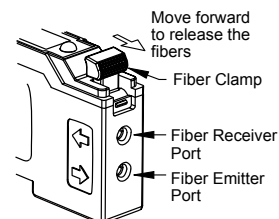

Fiber Adapters



NOTE: If a thin fiber with less than 2.2 mm outer diameter is used, install the fiber adapter provided with the fiber assembly to ensure a reliable fit in the fiber holder. Banner includes the adapters with all fiber assemblies.

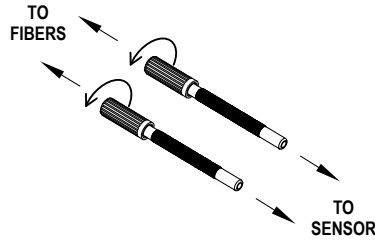

Fiber Outer Diameter (mm)	Adapter Color
Ø 1.0	Black
Ø 1.3	Red
Ø 2.2	No adapter needed

When connecting coaxial-type fiber assemblies to the amplifier, install the solid core fiber to the LED emitting port, and the multi-core fiber to the PD receiving port for most reliable detection.

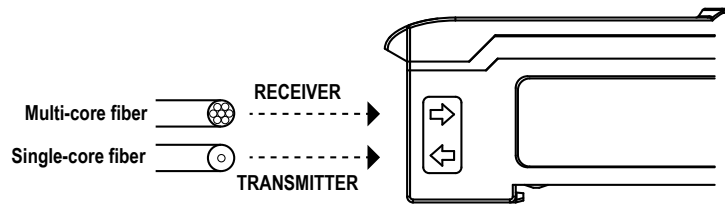

Wiring Diagrams

NPN Models

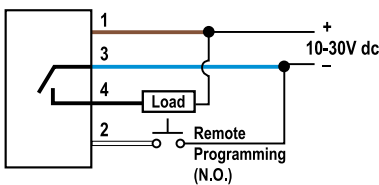

PNP Models

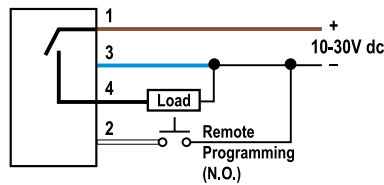

Key

- 1 = Brown
- 2 = White
- 3 = Blue
- 4 = Black

Euro

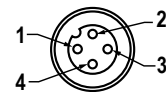

Pico

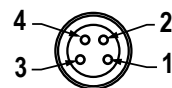

For cable options, see Banner Engineering website.

IO-Link Models

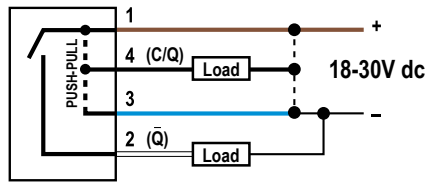

NOTE: Open lead wires must be connected to a terminal block.

Top Panel Interface

Opening the dust cover provides access to the top panel interface. The top panel interface consists of the RUN/PRG/ADJ mode switch, LO/DO switch, +/-SET/- rocker button, dual red/green digital displays, and output LED.

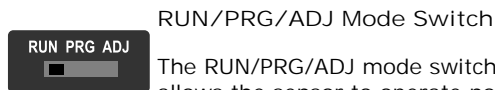

RUN/PRG/ADJ Mode Switch

The RUN/PRG/ADJ mode switch puts the sensor in RUN, PRG (Program), or ADJ (Adjust) mode. RUN mode allows the sensor to operate normally and prevents unintentional programming changes via the +/-SET/- button. PRG mode allows the sensor to be programmed through the display driven programming menu (see Program Mode below). ADJ mode allows the user to perform Expert TEACH/SET methods and Manual Adjust (see Adjust Mode below).



LO/DO Switch

The LO/DO switch is used to select Light Operate or Dark Operate mode. In Light Operate mode, the output is ON when the sensing condition is above the threshold (for Window SET, the output is ON when the sensing condition is inside the window). In Dark Operate mode, the output is ON when the sensing condition is below the threshold (for Window SET, the output is ON when the sensing condition is outside the window).

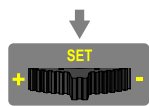

+/-SET/- Rocker Button

The +/-SET/- rocker button is a 3-way button. The +/- positions are engaged by rocking the button left/right. The SET position is engaged by clicking down the button while the rocker is in the middle position. All three button positions are used during PRG mode to navigate the display driven programming menu. During ADJ mode, SET is used to perform TEACH/SET methods and +/- are used to manually adjust the threshold(s). The rocker button is disabled during RUN mode, except when using Window SET, see [Window SET](#) on page 10.



Red/Green Digital Displays

During RUN and ADJ mode, the Red display shows the signal level and the Green display shows the threshold. During PRG mode, both displays are used to navigate the display driven programming menu.



Output LED

The output LED provides a visible indication when the output is activated.

Remote Input/IO-Link

For more information about how to perform TEACH/SET methods, to program the sensor remotely, or to interface with the sensor via IO-Link, see the DF-G1 Manual (P/N 161999).

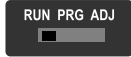

Run Mode

Run mode allows the sensor to operate normally and prevents unintentional programming changes. The +/SET/- rocker button is disabled during RUN mode, except when using Window SET, see [Window SET](#) on page 10.

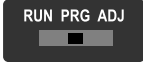

Program Mode

Program (PRG) mode allows the following settings to be programmed in the DF-G1:

Factory Default Settings:

Setting	Factory Default
Threshold	2026
TEACH Selection	Two-Point TEACH
Response Speed	Standard - 500 µs
Offset Percent	10%
Auto Thresholds	OFF
OFF Delay	0 (Disabled)
OFF One-Shot	0 (Disabled)
ON Delay	0 (Disabled)
ON One-Shot	0 (Disabled)
Display Readout	Numeric, ECO disabled, Normal Orientation
Gain Selection	Auto Gain

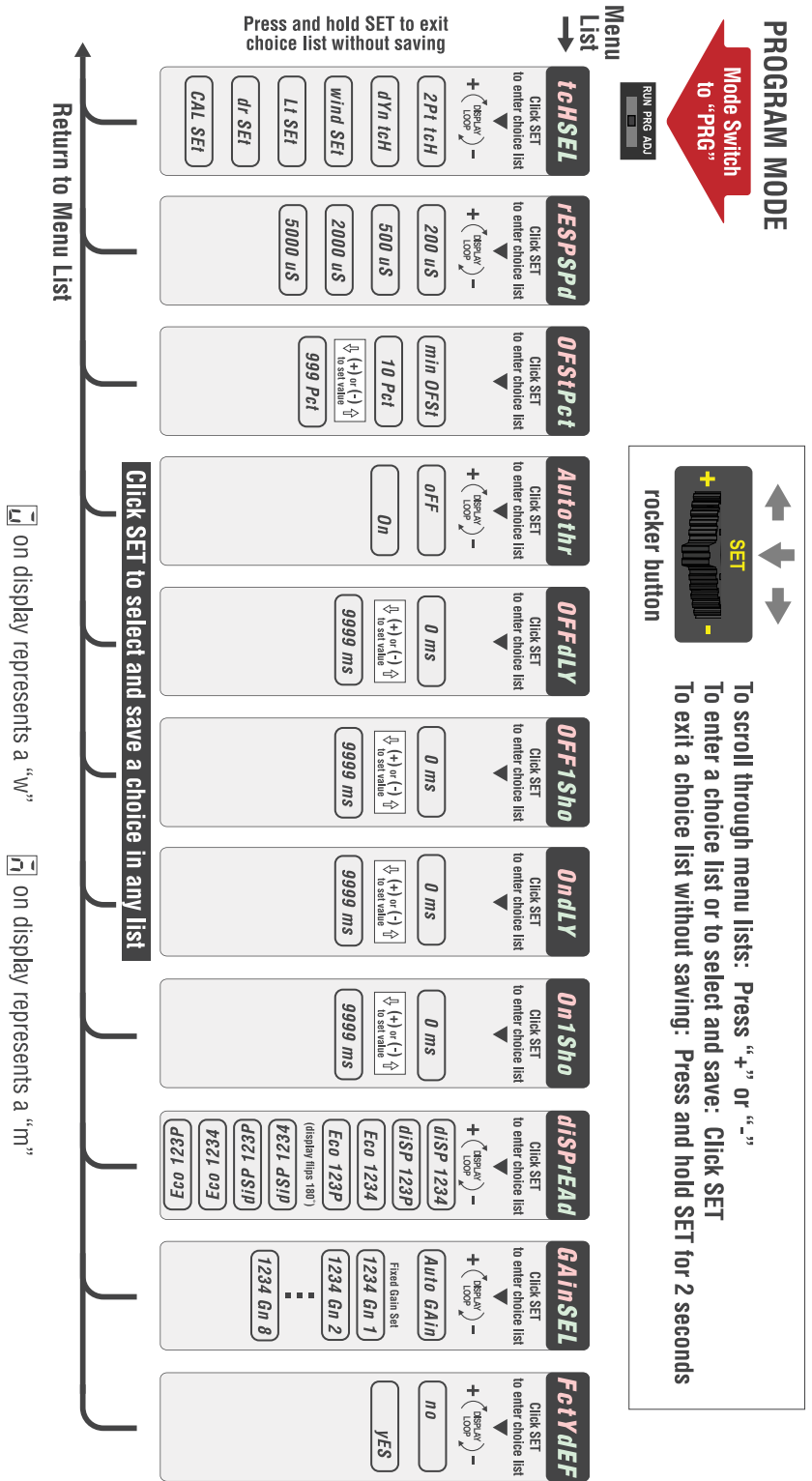



Adjust Mode

Sliding the RUN/PRG/ADJ mode switch to the ADJ position allows the user to perform Expert TEACH/SET methods and Manual Adjustment of the threshold(s).

Two-Point TEACH

- Establishes a single switching threshold
- Threshold can be adjusted using "+" and "-" rocker button (Manual Adjust)

Two-Point TEACH is used when two conditions can be presented statically to the sensor. The sensor locates a single sensing threshold (the switchpoint) midway between the two taught conditions, with the Output ON condition on one side, and the Output OFF condition on the other (see [Figure 2](#) on page 7).

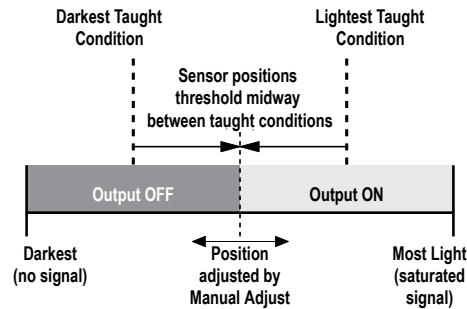

Figure 2. Two-Point TEACH (Light Operate shown)

The Output ON and OFF conditions can be reversed by using the LO/DO (Light Operate/ Dark Operate) switch (see LO/DO Switch in [Top Panel Interface](#) on page 4).

Two-Point TEACH and Manual Adjust

Moves switching threshold value up or down to make adjustments

- Slide Mode switch to ADJ to enter Adjust mode
- Press "+" to increase; press "-" to decrease
 - GREEN display shows the switching threshold value
 - 2 seconds after adjustment, the GREEN display will flash 3 times to confirm
- Slide Mode switch to RUN to complete operation



Remember: Manual adjustments are disabled when Auto Thresholds are ON

Follow these steps to perform a Two-Point TEACH:



Note: TEACH Selection must be programmed to 2Pt tch (see [Program Mode](#) on page 6)

1. Enter Adjust mode.

Method	Action	Result
SET Button ²	Set the Mode switch to ADJ.	Display: Red - Signal Level; Green - Threshold
Remote Input ³	No action is required; sensor is ready for the Two-Point TEACH method	



2. Teach the first condition.

² SET Button: 0.04 seconds ≤ "Click" ≤ 0.8 seconds

³ Remote Input: 0.04 seconds ≤ T ≤ 0.8 seconds

Method	Action	Result
SET Button	a. Present the first condition. b. Click the SET rocker button	Display: Flashes "2Pt tch" then holds on "1234 2nd"
Remote Input	a. Present the first condition. b. Single-pulse the remote input.	

3. Teach the second condition.

Method	Action	Result
SET Button	a. Present the second condition. b. Click the SET rocker button.	<u>TEACH Accepted</u> Displays alternate "PASS" and % Minimum Difference ⁴ ; Sensor returns to Adjust mode
Remote Input	a. Present the second condition. b. Single-pulse the remote input.	 <u>TEACH Not Accepted</u> Displays alternate "FAIL" and % Minimum Difference ⁴ ; Sensor returns to Adjust mode 

4. Return to Run mode.

Method	Action	Result
SET Button	Move the Mode switch to RUN	Display: Red - Signal Level; Green - Threshold
Remote Input	No action is required; sensor returns to RUN mode automatically	

Dynamic TEACH

- Teaches on-the-fly
- Establishes a single switching threshold
- Threshold can be adjusted using "+" and "-" rocker button (Manual Adjust)

Dynamic TEACH is best used when a machine or process may not be stopped for teaching. The sensor learns during actual sensing conditions, taking multiple samples of the light and dark conditions and automatically setting the threshold at the optimum level (see [Figure 3](#) on page 9).

⁴ See [Troubleshooting](#) on page 18 for more explanation of the % Minimum Difference displayed after the Two-Point TEACH method.

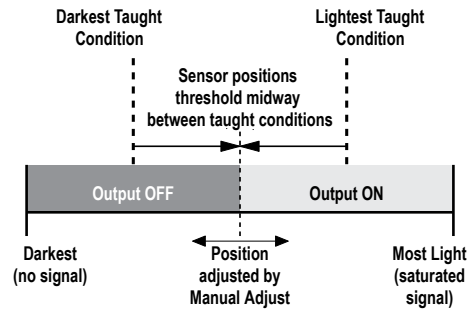

Figure 3. Dynamic TEACH (Light Operate shown)

The output ON and OFF conditions can be reversed using the LO/DO switch (see LO/DO Switch in [Top Panel Interface](#) on page 4).

Dynamic TEACH and Manual Adjust

Moves switching threshold value up or down to make adjustments

- Slide Mode switch to ADJ to enter Adjust mode
- Press "+" to increase; press "-" to decrease
 - GREEN display shows the switching threshold value
 - 2 seconds after adjustment, GREEN display will flash 3 times to confirm
- Slide Mode switch to RUN to complete operation

Remember: Manual adjustments are disabled when Auto Thresholds are ON

Follow these steps to perform a Dynamic TEACH:

NOTE: TEACH Selection must be programmed to dYn tch (see [Program Mode](#) on page 6)

1. Enter Adjust Mode.

Method	Action	Result
SET Button ⁵	Set Mode switch to ADJ	Display: Red - Signal Level; Green - Threshold
Remote Input ⁶	No action required; sensor is ready for Dynamic TEACH method	

2. Enter Dynamic TEACH.







Method	Action	Result
SET Button	Click the SET rocker button	Display: Flashes "dYn tch" then holds on "1234 dYn"
Remote Input	Single-pulse remote input	

3. Present ON and OFF Conditions.

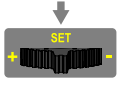

⁵ SET Button: 0.04 seconds ≤ "Click" ≤ 0.8 seconds
⁶ Remote Input: 0.04 seconds ≤ T ≤ 0.8 seconds

Method	Action	Result
SET Button	Present ON and OFF conditions	Display: Red - Signal Level; Green - Threshold 
Remote Input	Present ON and OFF conditions	

4. Exit Dynamic TEACH.

Method	Action	Result
SET Button	Click the SET rocker button 	<u>TEACH Accepted</u>
Remote Input	Single-pulse remote input 	Displays alternate "PASS" with % Minimum Difference ⁷ , Sensor returns to Adjust mode   <u>TEACH Not Accepted</u> Displays alternate "FAIL" with % Minimum Difference ⁷ , Sensor returns to Adjust mode  

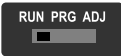
5. Return to RUN Mode.

Method	Action	Result
SET Button	Move Mode switch to RUN 	Display: Red - Signal Level; Green - Threshold 
Remote Input	No action required; sensor returns to RUN mode automatically	

Window SET

- Sets window thresholds that extend a programmable % offset above and below the presented condition
- All other conditions (lighter or darker) cause the output to change state
- Sensing window center can be adjusted using "+" and "-" rocker button (Manual Adjust)
- Recommended for applications where a product may not always appear in the same place, or when other signals may appear
- See Program Mode in the user's manual for programming the Offset Percent setting (to increase/decrease the window size)

A single sensing condition is presented, and the sensor positions window thresholds a programmable % offset above and below the presented condition. In LO mode, Window SET designates a sensing window with the Output ON condition inside the window, and the Output OFF conditions outside the window (see [Figure 4](#) on page 11).

⁷ See [Troubleshooting](#) on page 18 for more explanation of the % Minimum Difference displayed after the Dynamic TEACH method.

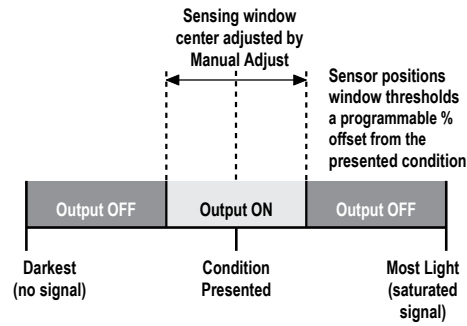

Figure 4. Window SET (Light Operate shown)

Output ON and OFF conditions can be reversed using the LO/DO switch (see LO/DO Switch in [Top Panel Interface](#) on page 4).

Window SET and Manual Adjust

Moves sensing window center value up or down to make adjustments

- Slide Mode switch to ADJ to enter Adjust mode
- Press "+" to increase; press "-" to decrease
 - GREEN display shows the sensing window center value
 - 2 seconds after adjustment, the GREEN display will flash 3 times to confirm
- Slide Mode switch to RUN to complete operation

Remember: Manual adjustments are disabled when Auto Thresholds are ON

Follow these steps to perform a Window SET:





Note: TEACH Selection must be programmed to wind SET (see [Program Mode](#) on page 6)

1. Enter Adjust Mode

Method	Action	Result
SET Button ⁸	Set Mode switch to ADJ	Display: Red - Signal Level; Green - Threshold
Remote Input ⁹	No action required; sensor is ready for Window SET method	

2. SET Sensing Condition

⁸ SET Button: 0.04 seconds ≤ "Click" ≤ 0.8 seconds
⁹ Remote Input: 0.04 seconds ≤ T ≤ 0.8 seconds

Method	Action	Result
SET Button	<ul style="list-style-type: none"> Present sensing condition Click the SET rocker button 	<p><u>Threshold Condition Accepted</u></p> <p>Displays read "wI nd SEt" then alternate "PASS" with % Offset¹⁰; Sensor returns to Adjust mode</p>  <p><u>Threshold Condition Not Accepted</u></p> <p>Displays read "wI nd SEt" then alternate "FAIL" with minimum % Offset¹⁰ for sensing condition; Sensor returns to Adjust mode</p> 
Remote Input	<ul style="list-style-type: none"> Present sensing condition Single-pulse the remote input 	

3. Return to RUN Mode

Method	Action	Result
SET Button	Move Mode switch to Run	<p>Display: Red - Signal Level; Green - Window Center (see Figure 5 on page 12 for instructions on how to display upper and lower thresholds)</p> 
Remote Input	No action required; sensor returns to Run mode automatically	

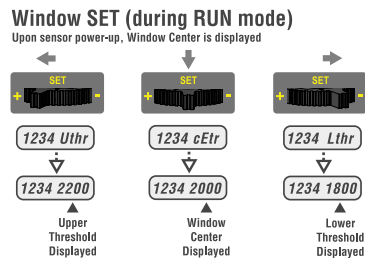

Figure 5. Upper and Lower Thresholds

Light SET

- Sets a threshold a programmable % offset below the presented condition
- Changes output state on any condition darker than the threshold condition
- Threshold can be adjusted using "+" and "-" rocker button (Manual Adjust)
- Recommended for applications where only one condition is known, for example a stable light background with varying darker targets
- See [Program Mode](#) on page 6 for programming the Offset Percent setting

A single sensing condition is presented, and the sensor positions a threshold a programmable % offset below the presented condition. When a condition darker than the threshold is sensed, the output either turns ON or OFF, depending on the LO/DO switch setting (see LO/DO Switch in [Top Panel Interface](#) on page 4).

¹⁰ See [Troubleshooting](#) on page 18 for more explanation of the % Offset displayed after the Window SET method

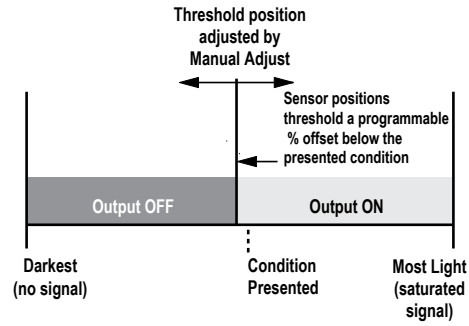

Figure 6. Light SET (Light Operate shown)

Light SET and Manual Adjust

Moves switching threshold value up or down to make adjustments

- Slide Mode switch to ADJ to enter Adjust mode
- Press "+" to increase; press "-" to decrease
 - GREEN display shows the switching threshold value
 - 2 seconds after adjustment, the GREEN display will flash 3 times to confirm
- Slide Mode switch to RUN to complete operation



Remember: Manual adjustments are disabled when Auto Thresholds are ON

Follow these steps to perform a Light SET:



Note: TEACH Selection must be programmed to Lt SET (see [Program Mode](#) on page 6)

1. Enter Adjust Mode

Method	Action	Result
SET Button ¹¹	Set Mode switch to ADJ	Display: Red - Signal Level; Green - Threshold
Remote Input ¹²	No action is required; sensor is ready for Light SET method	



2. SET Sensing Condition

¹¹ SET Button: 0.04 seconds ≤ "Click" ≤ 0.8 seconds

¹² Remote Input: 0.04 seconds ≤ T ≤ 0.8 seconds

Method	Action	Result
SET Button	<ul style="list-style-type: none"> Present sensing condition Click the SET rocker button 	<p><u>Threshold Condition Accepted</u></p> <p>Displays read "Lt SET" then alternate "PASS" with % Offset¹³; Sensor returns to Adjust mode</p>  <p><u>Threshold Condition Not Accepted</u></p> <p>Displays read "Lt SET" then alternate "FAIL" with minimum % Offset¹³ for sensing condition; Sensor returns to Adjust mode</p> 
Remote Input	<ul style="list-style-type: none"> Present sensing condition Single-pulse the remote input 	

3. Return to RUN Mode

Method	Action	Result
SET Button	 Move Mode switch to RUN	<p>Display: Red - Signal Level; Green - Threshold</p> 
Remote Input	No action required; sensor returns to RUN mode automatically	

Dark SET

- Sets a threshold a programmable % offset above the presented condition
- Any condition lighter than the threshold condition causes the output to change state
- Threshold can be adjusted using "+" and "-" rocker button (Manual Adjust)
- Recommended for applications where only one condition is known, for example a stable dark background with varying lighter targets
- See [Program Mode](#) on page 6 for programming the Offset Percent setting



NOTE: Offset Percent MUST be programmed to Minimum Offset to accept conditions of no signal (0 counts).

A single sensing condition is presented, and the sensor positions a threshold a programmable % offset above the presented condition. When a condition lighter than the threshold is sensed, the output either turns ON or OFF, depending on the LO/DO switch setting (see LO/DO Switch in [Top Panel Interface](#) on page 4).

¹³ See [Troubleshooting](#) on page 18 for more explanation of the % Offset displayed after the Light SET method

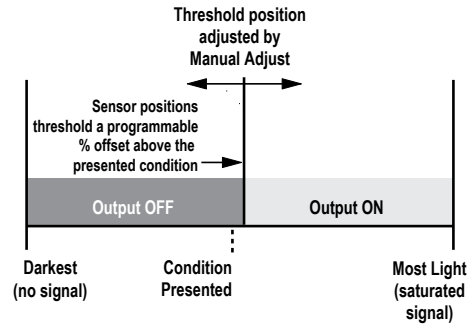

Figure 7. Dark SET (Light Operate shown)

Dark SET and Manual Adjust

Moves switching threshold value up or down to make adjustments

- Slide Mode switch to ADJ to enter Adjust mode
- Press "+" to increase; press "-" to decrease
 - GREEN display shows the switching threshold value
 - 2 seconds after adjustment, the GREEN display will flash 3 times to confirm
- Slide Mode switch to RUN to complete operation



Remember: Manual adjustments are disabled when Auto Thresholds are ON

Follow these steps to perform a Dark SET:



Note: TEACH Selection must be programmed to dr SET (see [Program Mode](#) on page 6)





1. Enter Adjust Mode.

Method	Action	Result
SET Button ¹⁴	Set Mode switch to ADJ	Display: Red - Signal Level; Green - Threshold
Remote Input ¹⁵	No action required; sensor is ready for Dark SET method	

2. SET Sensing Condition.

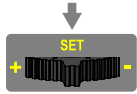
¹⁴ SET Button: 0.04 seconds ≤ "Click" ≤ 0.8 seconds

¹⁵ Remote Input: 0.04 seconds ≤ T ≤ 0.8 seconds

Method	Action	Result
SET Button	<ul style="list-style-type: none"> Present sensing condition Click the SET rocker button 	<p><u>Threshold Condition Accepted</u></p> <p>Displays read "dr SET" then alternate "PASS" with % Offset¹⁶; Sensor returns to Adjust mode</p> 
Remote Input	<ul style="list-style-type: none"> Present sensing condition Single-pulse the remote input 	<p><u>Threshold Condition Not Accepted</u></p> <p>Displays read "dr SET" then alternate "FAIL" with minimum % Offset¹⁶ for sensing condition; Sensor returns to Adjust mode</p> 

3. Return to RUN Mode.

Method	Action	Result
SET Button	Move Mode switch to RUN	<p>Display: Red - Signal Level; Green - Threshold</p> 
Remote Input	No action required; sensor returns to RUN mode automatically	

Calibration SET

- Sets a threshold exactly at the presented condition
- Threshold can be adjusted using "+" and "-" rocker button (Manual Adjust)

A single sensing condition is presented, and the sensor positions a threshold exactly at the presented condition. When a condition lighter than the threshold is sensed, the output either turns ON or OFF, depending on the LO/DO switch setting (see LO/DO Switch in [Top Panel Interface](#) on page 4).

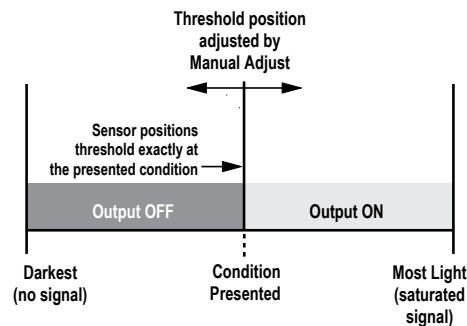

Figure 8. Calibration SET (Light Operate shown)

Calibration SET and Manual Adjust

Moves switching threshold value up or down to make adjustments

- Slide Mode switch to ADJ to enter Adjust mode
- Press "+" to increase; press "-" to decrease

¹⁶ See [Troubleshooting](#) on page 18 for more explanation of the % Offset displayed after the Dark SET method



- GREEN display shows the switching threshold value
- 2 seconds after adjustment, the GREEN display will flash 3 times to confirm
- Slide Mode switch to RUN to complete operation

 Remember: Auto Thresholding is automatically disabled in Calibration SET





Follow these steps to perform a Calibration SET:

 Note: TEACH Selection must be programmed to CAL SET (see [Program Mode](#) on page 6)



1. Enter Adjust Mode

Method	Action	Result
SET Button ¹⁷	<ul style="list-style-type: none"> • Set Mode switch to ADJ 	Display: Red - Signal Level; Green - Threshold 
Remote Input ¹⁸	No action required; sensor is ready for Calibration SET method	

2. SET Sensing Condition

Method	Action	Result
SET Button	<ul style="list-style-type: none"> • Present sensing condition • Click the SET rocker button 	Threshold Condition Accepted Displays read "cAL SET" then flashes "PASS"; Sensor returns to Adjust mode  Threshold Condition Unacceptable Displays read "cAL SET" then flashes "FAIL"; Sensor returns to Adjust mode 
Remote Input	<ul style="list-style-type: none"> • Present sensing condition • Single-pulse the remote input 	

3. Return to RUN Mode

Method	Action	Result
SET Button	Move Mode switch to RUN 	Display: Red - Signal Level; Green - Threshold 
Remote Input	No action required; sensor returns to RUN mode automatically	

¹⁷ SET Button: 0.04 seconds ≤ "Click" ≤ 0.8 seconds

¹⁸ Remote Input: 0.04 seconds ≤ T ≤ 0.8 seconds

Troubleshooting

Manual Adjustments Disabled

Manual adjustments are disabled when Auto Thresholds are ON. If a manual adjustment is attempted while Auto Thresholds are ON, the Green display will flash **Auto**.

Percent Minimum Difference after TEACH

The Two-Point and Dynamic TEACH methods will flash a % minimum difference on the displays after a PASS or FAIL.

Value	PASS/FAIL	Description
0 to 99%	FAIL	The difference of the taught conditions does not meet the required minimum
100 to 300%	PASS	The difference of the taught conditions just meets/exceeds the required minimum, minor sensing variables may affect sensing reliability
300 to 600%	PASS	The difference of the taught conditions sufficiently exceeds the required minimum, minor sensing variables will not affect sensing reliability
600% +	PASS	The difference of the taught conditions greatly exceeds the required minimum, very stable operation

Percent Offset after SET

The Window, Dark, and Light SET methods will flash a % offset on the displays after a PASS or FAIL.

SET Result	% Offset Meaning
PASS (with % Offset)	Displays the % offset used for the SET method
FAIL (with % Offset)	Displays the minimum required % offset necessary to PASS the SET method
FAIL (without % Offset)	Presented condition cannot be used for the SET method

Threshold Alert or Threshold Error

Severe contamination/changes in the taught condition can prevent the Auto Thresholds algorithm from optimizing the threshold(s).

State	Display	Description	Corrective Action
Threshold Alert	Alternates Err ALrt and 1234 1234	The threshold(s) cannot be optimized, but the sensor's output will still continue to function	Cleaning/correcting the sensing environment and/or a re-teach of the sensor is highly recommended
Threshold Error	Err Err	The threshold(s) cannot be optimized, and the sensor's output will stop functioning	Cleaning/correcting the sensing environment and/or a re-teach of the sensor is required

Specifications

Sensing Beam

660 nm visible red

Supply Voltage

NPN/PNP models: 10 to 30 V dc Class 2 (10% max ripple)
IO-Link models: 18 to 30 V dc (10% max ripple)

Power and Current Consumption (exclusive of load)

Standard display mode: 960 mW, Current consumption < 40 mA at 24 V dc
ECO display mode: 720 mW, Current consumption < 30 mA at 24 V dc

Supply Protection Circuitry

Protected against reverse polarity, overvoltage, and transient voltages

Delay at Power Up

500 milliseconds max.; outputs do not conduct during this time

Output Configuration

NPN/PNP models: 1 current sinking (NPN) or 1 current sourcing (PNP) output, depending on model
IO-Link models: 1 push-pull and 1 PNP (complementary outputs)

Output Rating

100 mA max. load (derate 1 mA per °C above 30 °C)
OFF-state leakage current: NPN/PNP models: < 5 µA at 30 V dc;
IO-Link models: < 50 µA at 30 V dc
ON-state saturation voltage: NPN: < 1.5 V; PNP /IO-Link: < 2 V

Output Protection

Protected against output short-circuit, continuous overload, transient over-voltages, and false pulse on power up

Output Response Time

High Speed: 200 µs; Standard: 500 µs; Long Range: 2 ms; Extra Long Range: 5 ms

Repeatability

High Speed: 66 µs, Standard/Long Range/Extra Long Range: 100 µs

Construction

Black ABS/polycarbonate alloy (UL94 V-0 rated) housing, clear polycarbonate cover

Environmental Rating

IEC IP50, NEMA 1

Operating Conditions

Temperature: -10 °C to +55 °C (+14 °F to +131 °F)
Storage Temperature: -20 °C to +85 °C (-4 °F to +185 °F)
Humidity: 90% at +60 °C maximum relative humidity (non-condensing)

IO-Link Interface

Supports Smart Sensor Profile: Yes
Baud Rate: 38,400 bps (COM2)
Process Data Width: 16 bits
I ODD files: Provide all programming options of top panel interface, plus additional functionality, see the DF-G1 Manual (P/N 161999)

Certifications



Ind. Cont. Eq.
3TJJ

Banner Engineering Corp Limited Warranty

Banner Engineering Corp. warrants its products to be free from defects in material and workmanship for one year following the date of shipment. Banner Engineering Corp. will repair or replace, free of charge, any product of its manufacture which, at the time it is returned to the factory, is found to have been defective during the warranty period. This warranty does not cover damage or liability for misuse, abuse, or the improper application or installation of the Banner product.

THIS LIMITED WARRANTY IS EXCLUSIVE AND IN LIEU OF ALL OTHER WARRANTIES WHETHER EXPRESS OR IMPLIED (INCLUDING, WITHOUT LIMITATION, ANY WARRANTY OF MERCHANTABILITY OR FITNESS FOR A PARTICULAR PURPOSE), AND WHETHER ARISING UNDER COURSE OF PERFORMANCE, COURSE OF DEALING OR TRADE USAGE.

This Warranty is exclusive and limited to repair or, at the discretion of Banner Engineering Corp., replacement. IN NO EVENT SHALL BANNER ENGINEERING CORP. BE LIABLE TO BUYER OR ANY OTHER PERSON OR ENTITY FOR ANY EXTRA COSTS, EXPENSES, LOSSES, LOSS OF PROFITS, OR ANY INCIDENTAL, CONSEQUENTIAL OR SPECIAL DAMAGES RESULTING FROM ANY PRODUCT DEFECT OR FROM THE USE OR INABILITY TO USE THE PRODUCT, WHETHER ARISING IN CONTRACT OR WARRANTY, STATUTE, TORT, STRICT LIABILITY, NEGLIGENCE, OR OTHERWISE.

Banner Engineering Corp. reserves the right to change, modify or improve the design of the product without assuming any obligations or liabilities relating to any product previously manufactured by Banner Engineering Corp.

