



LD46-UL
Luminescence sensor

INSTRUCTION MANUAL

CONTROLS

OUT LED (yellow)
The yellow LED indicates the output status.

READY LED (green)
During functioning, the green LED permanently ON indicates a normal operating condition and blinking indicates an output overload condition.

DELAY LED (orange)
The orange DELAY LED ON indicates the timing function activation on the digital output.

KEYLOCK LED (orange)
The orange KEYLOCK LED ON indicates the active keyboard status.

BARGRAPH
The reading sensitivity level is signalled on the bargraph.

SET PUSH-BUTTON (white)
The pressing of the SET push-button unlocks the keyboard, memorises the sensitivity and activates the digital output timing.

+ (red) and - (green) push-buttons
The sensitivity adjustment procedure is activated by pressing the + and - push-buttons.

See the "SETTING" paragraph for setup procedure indications.



INSTALLATION

The sensor can be positioned by means the two Ø3.5mm housing's holes using or threaded M5 holes with 6 mm max. depth.

Warning: the use of excessively long screws can damage the product.

The connector can be oriented at five different positions by rotating the block. The position chosen is guaranteed by a mechanical blocking system. The rotation can be carried-out even after sensor installation as the connector block is completely self-contained inside the housing.



Operating distance is rated starting from the lens front face.

CONNECTIONS

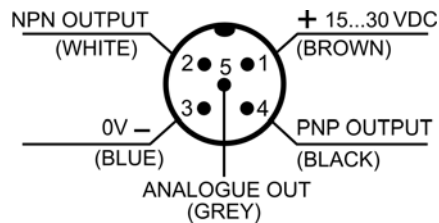

DIMENSIONS

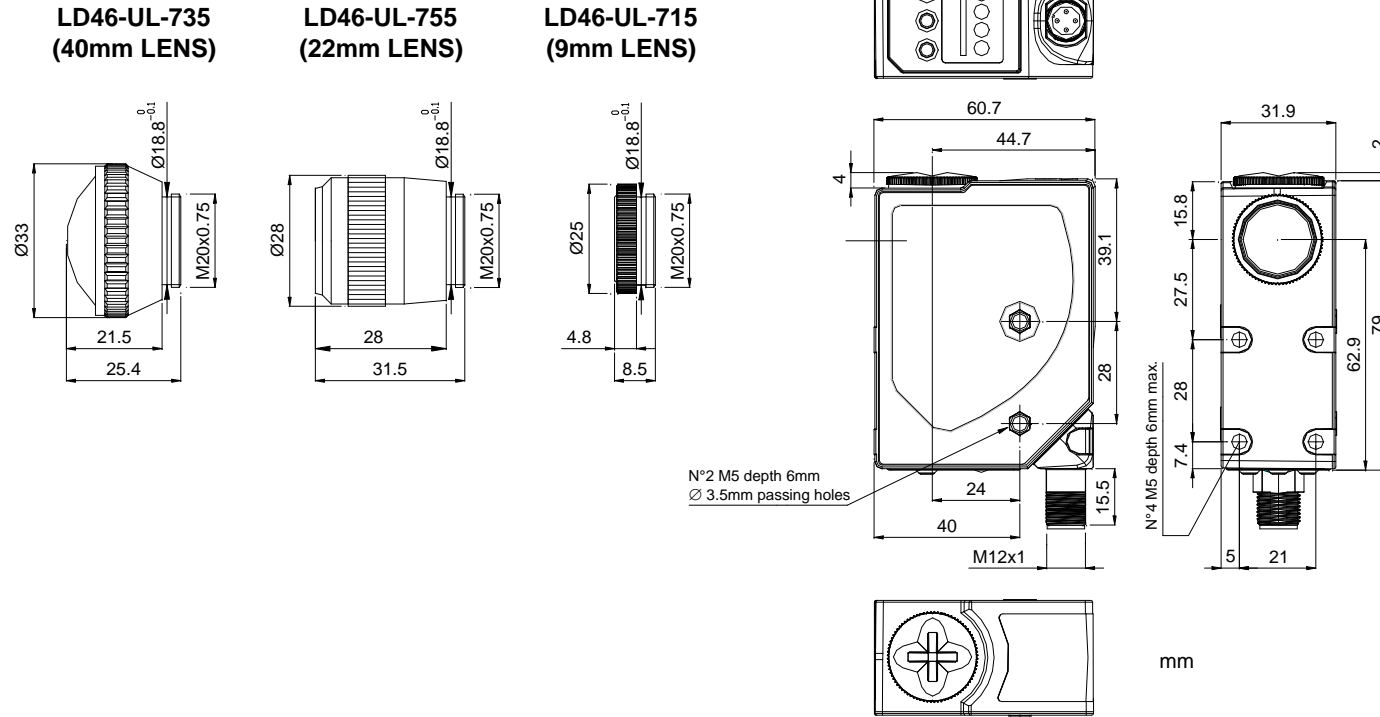

TECHNICAL DATA

Power supply:	15...30 Vdc limits value
Ripple:	2 Vpp max.
Consumption (output current excluded):	50mA max @ 24Vcc
Output:	1 PNP output 1 NPN output
Output current:	100 mA max.
Output saturation voltage:	≤ 2 V
Analogue output:	0.75 ... 5.5 V max.
Analogue output impedance:	2.2 kΩ (short-circuit protection)
Response time:	250 μs
Switching frequency:	2 kHz
Delay:	0 / 20 ms selectable (no-delay default configuration)
Indicators:	OUT LED (yellow) / READY LED (green) DELAY LED and KEYLOCK LED (orange) 5-segment bargraph
Push-buttons:	+, SET, -
Operating temperature:	-10 ... 55 °C
Storage temperature:	-20 ... 70 °C
Electric shock protection:	double insulation □
Operating distance:	10 ... 20 mm (LD46-UL-715) 20 ... 40 mm (LD46-UL-755) 30 ... 50 mm (LD46-UL-735)
Minimum spot dimension:	2 x 8 mm @ 10mm (LD46-UL-715) 3x11 mm @ 24mm (LD46-UL-755) 4x15 mm @ 50mm (LD46-UL-735)
Emission type:	UV 375nm LEDs, Class 1
Ambiente light rejection:	according to EN 60947-5-2
Vibrations:	0.5 mm amplitude, 10 ... 55 Hz frequency, per each axis (EN60068-2-6)
Shock resistance:	11 ms (30 G) 6 shock per each axis (EN60068-2-27)
Housing material:	Aluminium
Lens material:	Glass
Mechanical protection:	IP67
Connections:	M12 5-pole connector
Weight:	180 g. max.

SETTING

KEYLOCK function (patent-covered)
The KEYLOCK function deactivates the keyboard thus avoiding accidental changes in the sensor setting. At sensor powering the keyboard is blocked (KEYLOCK LED OFF). To activate it, press SET for 5 seconds until the KEYLOCK LED (orange) turns ON. The keyboard is automatically blocked if not used for 2 minutes. Unblock the keyboard to proceed with sensor adjustment.

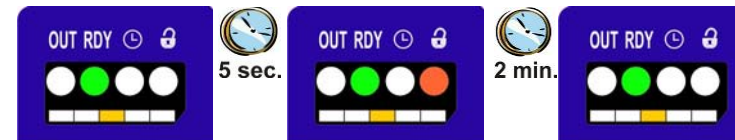

NORMAL FUNCTIONING
During normal functioning a LED on the bargraph visualises the sensitivity level.

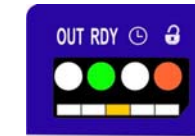

SENSITIVITY ADJUSTMENT
This mode regulates the sensor reading sensitivity, i.e. the capability of detecting objects with different luminescence degrees. The sensitivity is increased or decreased by pressing the + or - push-buttons. The adjustment speed is increased by keeping the + or - push-buttons pressed.

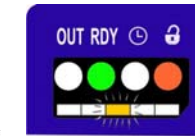

The sensitivity level which is being set blinks on the bargraph during this phase.

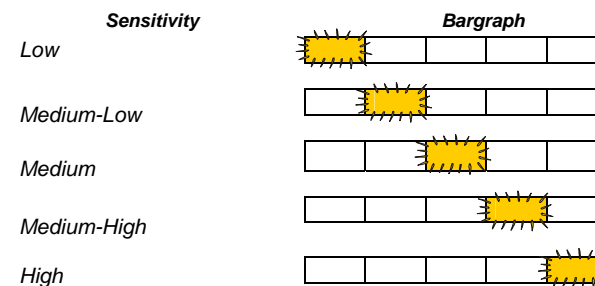

Press SET to memorise the new threshold value or wait 30sec for automatic save.

DELAY SETTING
The DELAY extends the minimum active output status duration to 20ms, allowing even slower interface systems to detect shorter pulses. The delay is signalled by the corresponding orange LED ON.

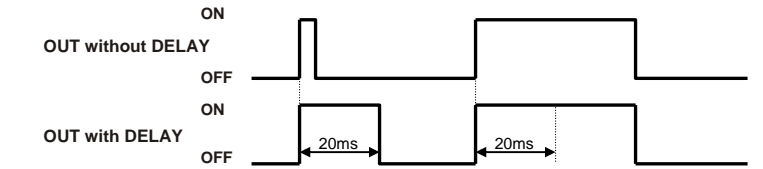

Delay activation
- Press SET for 2 sec until DELAY LED turns ON.

Delay deactivation
- Press SET for 2 sec until DELAY LED turns OFF.

OUTPUT OVERLOAD
The digital output overload is signalled by the rapid blinking of the READY LED.

ANALOGUE OUTPUT
The analogue output supplies a voltage proportional to the signal received by the sensor. The voltage supplied is 0.75 ÷ 5.5V.

DETECTION DIAGRAM

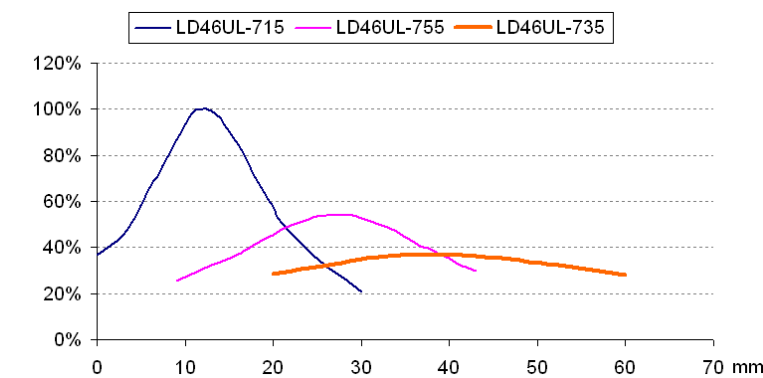

	EX-II-3DG IP67 T6	
	Temperature class:	T6 (<85°C)
	Max. Power consumption:	1500 mW at 30 Vdc
	Max. Internal capacitance:	380 pF
	Internal inductance:	negligible

DECLARATION OF CONFORMITY
We DATALOGIC AUTOMATION declare under our sole responsibility that these products are conform to the 2004/108/CE and successive amendments.

WARRANTY
DATALOGIC AUTOMATION warrants its products to be free from defects. DATALOGIC AUTOMATION will repair or replace, free of charge, any product found to be defective during the warranty period of 36 months from the manufacturing date. This warranty does not cover damage or liability deriving from the improper application of DATALOGIC AUTOMATION products.

DATALOGIC AUTOMATION cares for the environment: 100% recycled paper. DATALOGIC AUTOMATION reserves the right to make modifications and improvements without prior notification. Datalogic and the Datalogic logo are registered trademarks of Datalogic S.p.A. in many countries, including the U.S.A. and the E.U.